

Cahier technique no. 149

EMC: electromagnetic compatibility

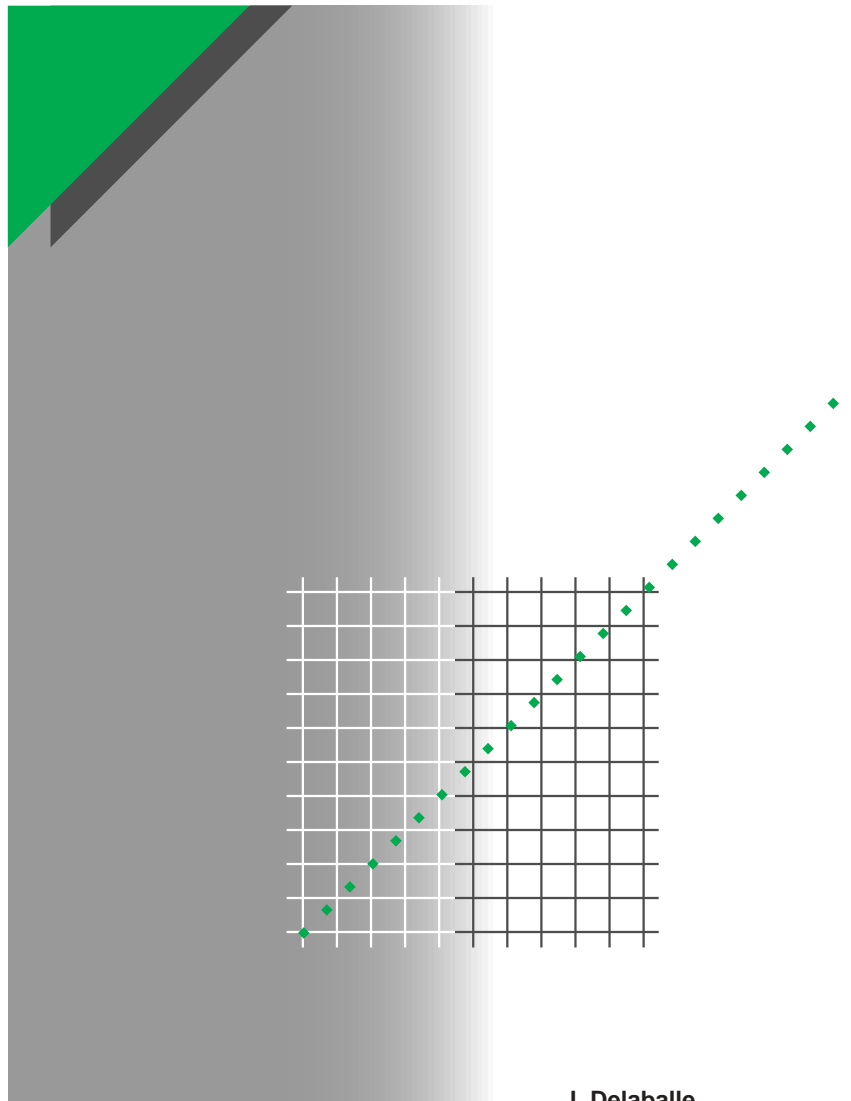

Merlin Gerin

Modicon

Square D

Telemecanique

J. Delaballe

"Cahiers Techniques" is a collection of documents intended for engineers and technicians, people in the industry who are looking for more in-depth information in order to complement that given in product catalogues.

Furthermore, these "Cahiers Techniques" are often considered as helpful "tools" for training courses.

They provide knowledge on new technical and technological developments in the electrotechnical field and electronics. They also provide better understanding of various phenomena observed in electrical installations, systems and equipments.

Each "Cahier Technique" provides an in-depth study of a precise subject in the fields of electrical networks, protection devices, monitoring and control and industrial automation systems.

The latest publications can be downloaded from the Schneider Electric internet web site.

Code: <http://www.schneider-electric.com>

Section: **Experts' place**

Please contact your Schneider Electric representative if you want either a "Cahier Technique" or the list of available titles.

The "Cahiers Techniques" collection is part of the Schneider Electric's "Collection technique".

Foreword

The author disclaims all responsibility subsequent to incorrect use of information or diagrams reproduced in this document, and cannot be held responsible for any errors or oversights, or for the consequences of using information and diagrams contained in this document.

Reproduction of all or part of a "Cahier Technique" is authorised with the prior consent of the Scientific and Technical Division. The statement "Extracted from Schneider Electric "Cahier Technique" no." (please specify) is compulsory.

no. 149

EMC: electromagnetic compatibility



Jacques DELABALLE

Ph.D University of Limoges in 1980, joined Merlin Gerin in 1986, after seven years at Thomson.

EMC laboratory manager at the Schneider Electric test center, he is also a member of Committee 77 (Electromagnetic Compatibility) of the International Electrotechnical Commission (IEC).

Lexicon

Electromagnetic compatibility, EMC (abbreviation) (IEV 161-01-07)

The ability of an equipment or system to function satisfactorily in its electromagnetic environment without introducing intolerable electromagnetic disturbances to anything in that environment.

(Electromagnetic) compatibility level (IEV 161-03-10)

The specified maximum disturbance level to which a device, equipment or system operated in particular conditions is likely to be subjected.

Note: In practice the electromagnetic compatibility level is not an absolute maximum level but may be exceeded by a small probability.

(Electromagnetic) disturbance (IEV 161-01-05)

Any electromagnetic phenomenon which may degrade the performance of a device, equipment or system, or adversely affect living or inert matter. Note: An electromagnetic disturbance may be an electromagnetic noise, an unwanted signal or a change in the propagation medium.

(Electromagnetic) susceptibility (IEV 161-01-21)

The inability of a device, equipment or system to perform without degradation in the presence of an electromagnetic disturbance.

Disturbance level

(not defined in IEC 61000)

Level of an electromagnetic disturbance of a given form, measured in particular conditions.

Disturbance limit

(IEV 161-03-08)

The maximum permissible electromagnetic disturbance level, measured in particular conditions.

Immunity level

(IEV 161-03-14)

The maximum level of a given electromagnetic disturbance on a particular device, equipment or system for which it remains capable of operating at a required degree of performance.

Figure 1 shows a graphical representation of the above definitions.

Decibel

The decibel is a unit of sound pressure that is also used to express amplitude ratios according to:

$$X/X_0 \text{ (dB@)} = 20 \log_{10} X/X_0$$

where

X = measured amplitude

X₀ = reference amplitude

@ = measurement unit for X and X₀

A few sample values are given in the table below (see fig. 2).

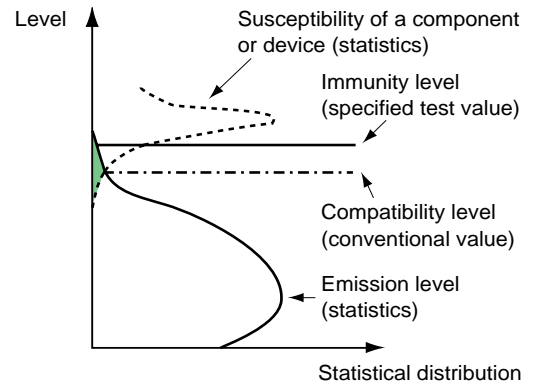

Fig. 1: Graphical representation of various EMC terms

X/X ₀ amplitude ratio	dB
1	0
1.12	1
1.25	2
1.41	3
2	6
3.2	10
4	12
5	14
10	20
100	40
1000	60

Fig. 2: Amplitude ratios expressed in decibels

EMC: electromagnetic compatibility

For all electrotechnical equipment, EMC must be considered right from the initial design phase and the various principles and rules carried on through to manufacture and installation.

This means that all those involved, from the engineers and architects that design a building to the technicians that wire the electrical cabinets, including the specialists that design the various building networks and the crews that install them, must be concerned with EMC - a discipline aimed at achieving the "peaceful" coexistence of equipment sensitive to electromagnetic disturbances (which may therefore be considered as the "victim") alongside equipment emitting such disturbances (in other words, the "source" of the disturbances).

This publication is a compilation of many years of acquired experience at Schneider Electric, presenting various disturbances encountered and providing some practical remedies.

Contents

1 Introduction	1.1 Electromagnetic compatibility - EMC - a characteristic and a discipline	p. 4
	1.2 Today, EMC is indispensable	p. 4
	1.3 EMC theory is complex	p. 5
2 The source	2.1 The importance of identifying the source	p. 6
	2.2 An example of a continuous source of conducted disturbances in power electronics	p. 7
	2.3 An example of radiated disturbance sources: circuit closing in MV and VHV substations	p. 8
3 Coupling	3.1 Different coupling modes exist	p. 10
	3.2 Common or differential mode field to wire coupling	p. 10
	3.3 Common impedance coupling	p. 12
	3.4 Differential mode wire to wire coupling or crosstalk	p. 12
4 The victim	4.1 Equipment malfunction	p. 14
	4.2 Solutions to the problem	p. 14
5 Installation	5.1 Installation is an important factor in the overall system EMC	p. 17
	5.2 Design phase	p. 17
	5.3 Installation phase	p. 18
	5.4 Practical examples	p. 18
6 Standards, test facilities and tests	6.1 Standards	p. 20
	6.2 Test facilities	p. 20
	6.3 Tests	p. 21
7 Conclusion		p. 27
Appendix 1: Impedance of a conductor at high frequencies		p. 28
Appendix 2: The different parts of a cable		p. 29
Appendix 3: Tests performed at the Schneider Electric EMC laboratories		p. 30
Appendix 4: Bibliography		p. 31

1 Introduction

1.1 Electromagnetic compatibility - EMC - a characteristic and a discipline

EMC is a characteristic of equipment or systems that mutually withstand their respective electromagnetic emissions.

According to the International Electrotechnical Vocabulary IEC 60050-101-07, EMC is the ability of a device or system to function satisfactorily in its electromagnetic environment without introducing

intolerable electromagnetic disturbances to anything in that environment.

EMC is now also a discipline aimed at improving the coexistence of equipment or systems which may emit electromagnetic disturbance and/or be sensitive to them.

1.2 Today, EMC is indispensable

Equipment and systems are always subjected to electromagnetic disturbance, and any electrotechnical equipment is, itself, more or less an electromagnetic disturbance generator.

These disturbances are generated in many ways. However, the main underlying causes are sudden variations in current or voltage.

The most common electrical disturbances (see **fig. 3**) in the low voltage electrotechnical field are discussed in "Cahier Technique" no. 141. "Cahier Technique" no. 143 discusses disturbances generated when operating medium voltage switchgear.

These disturbances can be propagated by conduction along wires or cables or by radiation in the form of electromagnetic waves.

Disturbances cause undesirable phenomena. Two examples are radio wave interference and interference with control and monitoring systems caused by electromagnetic emissions.

In recent years, several trends have together made EMC more important than ever:

- Disturbances are becoming stronger with increasing voltage and current values.
- Electronic circuits are becoming increasingly sensitive.
- Distances between sensitive circuits (often electronic) and disturbing circuits (power circuits) are becoming smaller.

In the development of its products, such as the Merlin Gerin protection switchgear as shown in

Class	Type	Origin
High energy	Voltage dips	<ul style="list-style-type: none"> ■ Power source switching ■ Short circuits ■ Starting of high power motors
Medium frequency	Harmonics	<ul style="list-style-type: none"> ■ Systems with power semi-conductors ■ Electric arc furnaces
High frequency	Overvoltages	<ul style="list-style-type: none"> ■ Direct or indirect lightning strikes ■ Switching of control devices ■ Breaking of short-circuit currents by protection devices
	Electrostatic discharges	Discharge of static electricity stored in the human body

Fig. 3: The most common electric disturbances

figure 4, Schneider Electric foresaw the necessity of understanding and applying EMC principles. In modern electrical switchgear and control gear, low and high currents, control and power electronics, electronic protection and electric power devices all reside in close proximity.

EMC is therefore a fundamental criterion that must be respected in all phases of product development and manufacture, as well as during installation and wiring.

Moreover, EMC is now included in standards and is becoming a legal requirement. The experience and achievements of Schneider Electric are not limited to the satisfactory operation of electrical and/or electronic systems in their usual electromagnetic environment: for example, Merlin Gerin designs and builds equipment capable of withstanding the harshest conditions such as electromagnetic radiation generated by high-altitude nuclear blasts.

The necessary radiation hardening, i.e. improvement of the immunity of systems exposed to electromagnetic pulses from nuclear sources, requires consideration of the most advanced EMC techniques.



Fig. 4: EMC application example: a medium-voltage SM6 panel containing a circuit breaker designed to interrupt power (hundreds of amperes under tens of kilovolts), and a SEPAM programmable control, monitoring and protection unit. The complete assembly must remain operational under all circumstances.

1.3 EMC theory is complex

Any work involving EMC involves the analysis of a three-component system:

- The disturbance generator or source
- Propagation or coupling
- The device or system affected or the victim

Strictly speaking, the three entities are not independent but for all practical purposes are assumed to be.

Note that installation, described in chapter 5, plays the most important role in the propagation of disturbances.

Theoretical analysis is difficult because it must deal with the propagation of electromagnetic

waves described by a set of complex differential equations known as Maxwell's equations.

Generally speaking, they cannot be solved to yield an analytical solution for real devices and dimensions. Even with powerful computer systems, a close numerical solution is often extremely difficult to obtain.

In practice, EMC problems must therefore be dealt with via simplifying assumptions, the use of models and in particular conducting experiments and taking measurements.

2 The source

2.1 The importance of identifying the source

The identification and measurement of the source is essential since the type of source will determine which of the following measures must be taken:

- Limiting the disturbances generated (e.g. on a contactor, by installing an interference suppressing RC unit in parallel with the A.C. coil, or a diode on the D.C. coil)
- Avoiding cross-coupling (i.e. physically separate two highly incompatible elements)
- Desensitizing potential victims (e.g. using shielding)

Main causes

Any device or physical/electrical phenomenon that emits an electromagnetic disturbance, either conducted or radiated, qualifies as a source.

The main causes of electromagnetic disturbance are electric power distribution, radio waves, electrostatic discharge and lightning.

- In electric power distribution, a large number of disturbances are created by circuit switching operations:
 - In the low voltage field, the opening of inductive circuits such as contactor coils, motors, solenoid valves etc. generates very high surge voltages (up to several kV across the coil terminals) that contain high-frequency harmonics (ten to hundreds of MHz).
 - In the medium and high voltage fields, the opening and closing of disconnectors produces waves with a very fast rate of rise (a few nanoseconds). These waves are particularly harmful to microprocessor-based systems.
- Radio waves emitted by remote monitoring systems, remote controls, radio communications, television sets, walkie-talkies etc. are, for some equipment, sources of disturbance in the order of several volts per meter. All of these disturbance emitters are nowadays increasingly common and susceptible equipment must therefore be provided with increasingly effective protection.
- An electrically-charged human body: for example, a person walking on certain types of carpet in a cold and dry climate can be charged up to more than 25 kV! Any contact with electronic equipment produces a discharge with a very fast rise time (several nanoseconds)

which enters the device by conduction and radiation, generating a major disturbance.

Disturbance characteristics

Sources may be intentional (e.g. radio transmitters) or not (e.g. arc welding units). However in general they can be distinguished by the characteristics of the disturbances they produce:

- Spectrum
 - Waveform, rise time or envelope of the spectrum
 - Amplitude
 - Energy
 - The spectrum, i.e. the frequency band covered by the disturbance can be very narrow, as in the case of mobile telephones, or very wide, as for electric arc furnaces.
- Pulse type disturbances cover a particularly wide spectrum extending up to 100 MHz or more (see **fig. 5**). To this last category belong almost exclusively sources such as:
- Electrostatic discharge
 - Switching of relays, disconnectors, contactors, switches and circuit breakers in the LV, MV and HV range
 - Lightning
 - Nuclear electromagnetic pulses (a special domain)

Since the degree of coupling is directly proportional to frequency, EMC uses the frequency domain to characterize disturbances. This type of representation, for a periodic signal, is similar to a Fourier series decomposition (as a sum of harmonics).

- The waveform describes the characteristics of the disturbance over time and can, for example, be a damped sine wave or double exponential function. It is expressed as a rise time t_r , an equivalent frequency $0.35/t_r$, or simply the disturbance frequency for a narrow band signal or as a wavelength λ , related to frequency by $\lambda = c/f$, where c is the speed of light ($3 \times 10^8 \text{ ms}^{-1}$).
- The amplitude is the maximum value the signal reaches in terms of voltage (Volts), electric field (Volts/meter), etc.
- The energy is the integral of the instantaneous energy over the time the disturbance lasts (Joules).

Radio wave

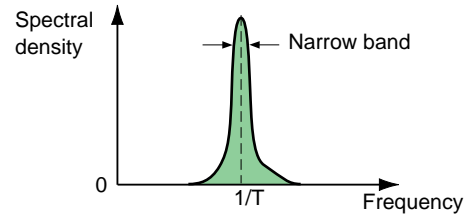
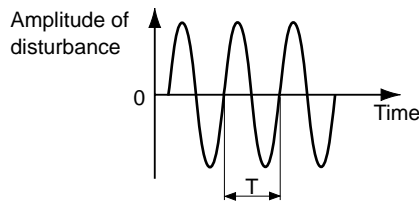

Indirect lightning effect

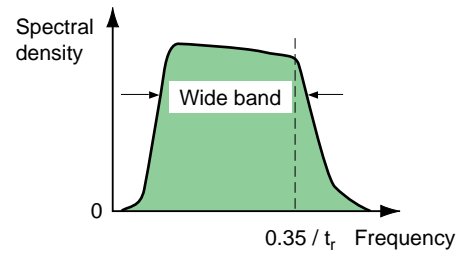
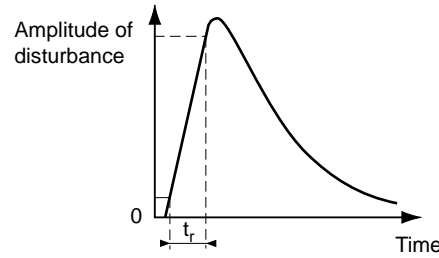

Fig. 5: Examples of spectral characteristics of disturbances

2.2 An example of a continuous source of conducted disturbance in power electronics

In power electronics, the principal sources of disturbance tend to be voltage rather than current transients. The voltages can vary by hundreds of volts in a matter of a few nanoseconds giving dV/dt s in excess of 10^9 V/s. Pulse Width Modulation (PWM) (see **fig. 6**), for example, used to generate a sine wave voltage from a D.C. voltage, works with voltage changes

from 0 to U_{dc} (660 V for rectified three-phase) occurring in a very short time, nano to microseconds depending on the technology used.

Rapid voltage changes are the source of various disturbance phenomena, the most problematic of which is, based on experience, the generation of currents flowing through any stray capacitances.

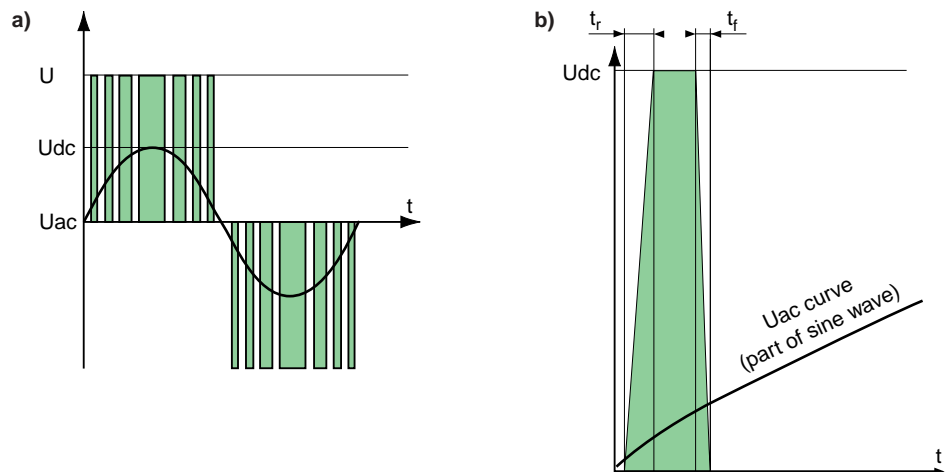

Fig. 6: A source of disturbance in power electronics equipment: the technique of switching by pulse width modulation

a: Principle

b: A considerably enlarged impulse (expanded scale for t); the part of the sine wave is disproportionate since it covers 20 ms; $t_r \approx 2$ to $3 t_f$ (10 ns to 1 μ s)

Taking only the stray capacitance C_p into account, the common mode current: $I_{CM} = C_p dV/dT$.

With the rise times mentioned earlier, a stray capacitance of 100 pF is sufficient to generate currents of several hundred milliamperes. This disturbance current will flow through the zero reference conductor and can modify signals (data or commands), be superimposed on sensitive measurements and disturb other equipment by injecting the disturbance back into the public distribution network.

One way of dealing with this type of phenomenon, i.e. of ensuring EMC, is to increase the voltage rise time.

However such a solution would considerably increase the switching losses in the transistors, producing harmful thermal stresses. Another effective way of reducing common mode currents consists of increasing the common mode impedance. For example, when mounting electronic power components, either of the two following methods are commonly used:

- Leave the heat sinks floating (no electric connection), (see **fig. 7**), if safety regulations are not violated.
- Reduce the stray capacitance between the device and the heat sink using an insulator with a low dielectric constant (see **fig. 8**).

In the field of UPS systems - Uninterruptible Power Supplies - for instance, the above precautionary measures make the difference between a "polluting" system and a "clean" system. For UPS systems, note that the low-level electronics in the static inverter must be protected against disturbances created by its own power circuits.

It is necessary to understand and control the phenomenon at the source to limit conducted emissions effectively and economically.

Other less frequent sources of conducted disturbance exist, such as lightning and switching surges that can generate large dV/dt s and dI/dt s. These disturbances also generate radiated fields.

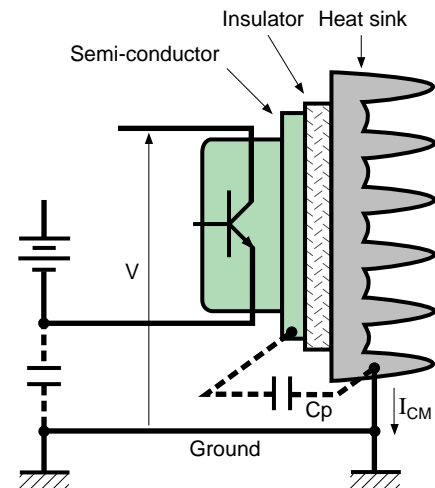

Fig. 7: The stray capacitance of the heat sink (for cooling electronic components) is taken into account in the design of UPS inverter stacks

Insulating washer for TO3 case	Thickness (mm)	Stray capacitance (pF)
Mica	0.1	160
Plastic	0.2	95
Alumina	2	22

Fig. 8: Typical stray capacitances for the most common insulators used in mounting electronic components

2.3 An example of radiated disturbance sources: circuit closing in MV and VHV substations

The substation environment, especially in medium and very high voltage applications, can contain very strong pulsed electromagnetic fields.

Certain switchgear operations can generate voltages much higher than the rated value in a very short time. For example, when a 24 kV switch is closed, the preignition phenomenon causes voltage variations of tens of kilovolts in a few nanoseconds (10^{-9} s). This is discussed in greater detail in "Cahier Technique" no. 153: "SF6 Fluarc circuit breakers and MV motor protection".

Measurements performed at the Schneider laboratories have shown that during the switching of a 24 kV medium voltage circuit breaker, damped sinusoidal pulsed fields reach

peak values of 7.7 kV/m with a frequency of 80 MHz at a distance of one meter from the cubicle. The field strength is enormous when compared to that of a 1 W portable two-way radio (walkie-talkie) which generates 3 to 5 V/m measured at a distance of one meter. The transients are propagated along conductors, busbars, cables and overhead lines. At the frequencies involved, i.e. the rapidity of the phenomenon, the conductors (especially busbars) behave like antennae and the characteristics of the electromagnetic fields they emit are highly dependent on the design of the metal enclosures (partitioning, cubicles).

In metal-clad very high voltage substations, the electromagnetic fields are particularly strong. Metal-clad SF6-insulated substations have a

coaxial shape and therefore display a constant characteristic impedance. Rapid voltage changes inside the tubular metal enclosures generate standing wave phenomena. They are created by reflections occurring at impedance mismatches due to conic outgoing feedthroughs that cross the shielding for example. The magnitude and duration of the phenomenon is also increased by this effect.

The electronic environment at medium and very high voltages requires in-depth electromagnetic compatibility studies for the design and installation of relay systems and control and monitoring devices. This is particularly important because in addition to the radiated disturbances, conducted voltage transients are also generated in substations as discussed at the beginning of this section (see [fig. 9](#)).

a)



b)



c)



Fig. 9: Three examples of devices with digital electronics developed by Schneider Electric and designed taking full consideration of EMC research.

a: A SEPAM protection and control unit integrated in MV equipment (Merlin Gerin brand)

b: A protection and control unit for Masterpact LV circuit-breakers (Merlin Gerin brand)

c: An ATV variable speed drive (Telemecanique brand)

3 Coupling

3.1 Different coupling modes exist

Coupling refers to the linking, transfer or transmission of electromagnetic disturbances from an emitter to a victim.

Coupling is expressed in terms of a coupling coefficient k , expressed in dB (e.g. -75 dB), which can be seen as the transmission efficiency of the disturbance from the emitter to the potential victim
 $(k = 20 \log A \text{ (received)}/A \text{ (transmitted)})$, where A is the amplitude of the disturbance).

It is important to define this coefficient for EMC since the lower the coefficient (the larger its absolute value in decibels) the weaker the

disturbance voltage received by the victim and the better the EMC.

This coefficient k is only meaningful when the transfer of electromagnetic disturbances is proportional to frequency, which is often the case in practice.

Three well known coupling modes can be distinguished:

- Common and differential mode field-to-wire coupling
- Common impedance coupling
- Differential mode wire-to-wire coupling or crosstalk

3.2 Common or differential mode field-to-wire coupling

An electromagnetic field can couple into any kind of wire-like structure and generate either common mode (with respect to ground) or differential mode (between wires) voltages or, as is generally the case, both. This type of coupling is called field-to-wire coupling and is also known as the antenna effect of wiring, printed circuit board tracks, etc.

- Common mode coupling generates common mode disturbance voltages or currents.

A conducted common mode voltage disturbance (VCM) is a voltage that affects all live conductors.

It is referenced to chassis or earth ground (typically in electrical systems): all common mode isolation tests on low voltage circuit breakers are therefore performed between earth ground and all phases.

A common mode current (ICM) is a current that flows through all live conductors in the same direction (see [fig. 10](#)). The current induced in a LV line by a lightning impulse is a common mode current.

- Differential mode coupling involves voltages and currents in the classic sense, for example, between two phases of a circuit breaker or

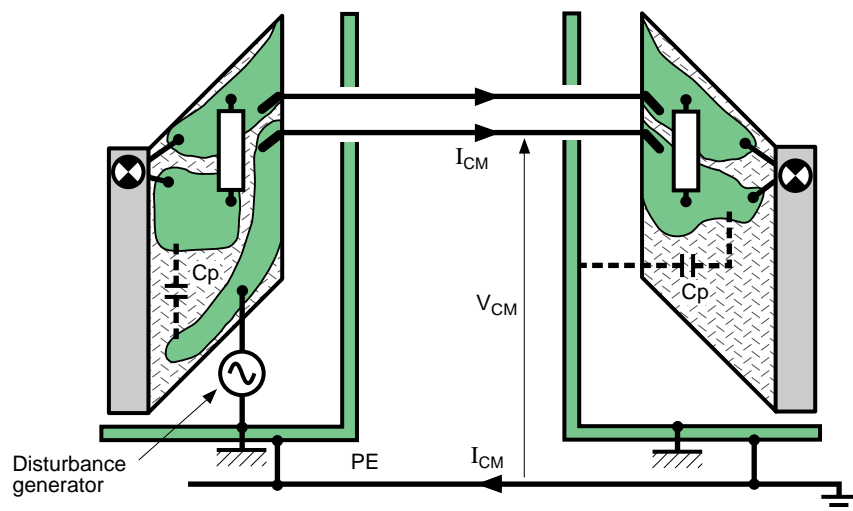

Fig. 10: Common mode voltage and current between two relays of a low voltage compartment in a medium voltage cubicle

between two wires which transmit sensor data to the electronics.

The equations that govern the coupling between the electromagnetic field (impedance of an arbitrary wave) and a wire-like structure (which can also be arbitrary) are very complex. In most cases they can neither be solved analytically nor numerically.

Nonetheless, one of the simpler and most common types of coupling can be expressed analytically: the coupling between the magnetic component of an electromagnetic field and a loop of area A formed by the conductors (see **fig. 11**).

The magnetic component H of the field induces in the loop a series voltage equal to:

$$e = \mu_0 'A' dH/dt$$

where μ_0 = the permeability in vacuum ($4\pi \cdot 10^{-7}$ H/m)

For example, in a medium voltage substation, a loop (of wire or cable) covering 100 cm^2 placed 1 m from the cubicle (see **fig. 12**) and exposed to a pulsed field of 5.5 kVrms/m (laboratory measurement) will generate (by induction) a series transient voltage of 15 V .

The above equation holds as long as the largest dimension of the loop does not exceed a tenth

of the wavelength of the disturbance. Note that such a green/yellow wire loop (see **fig. 12**) is easily created in the "relay compartment" when the wires are connected in a star configuration to ground.

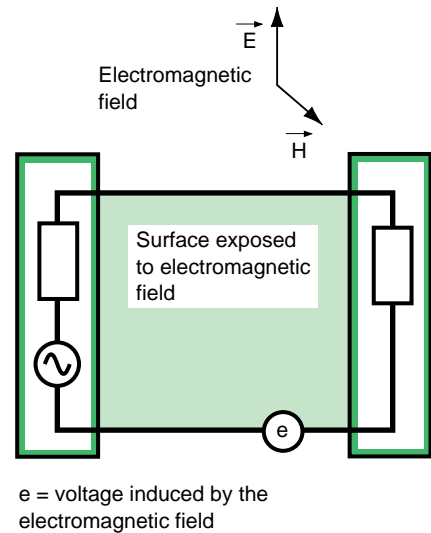

Fig. 11: An example of differential mode field-to-wire coupling

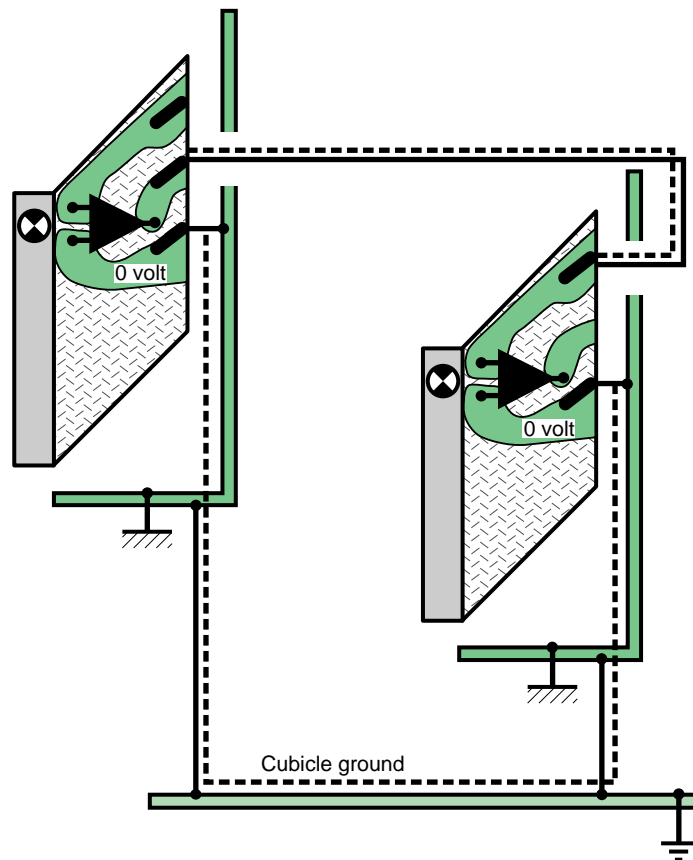

Fig. 12: Example of a ground loop in a low voltage compartment of a medium voltage cubicle

3.3 Common impedance coupling

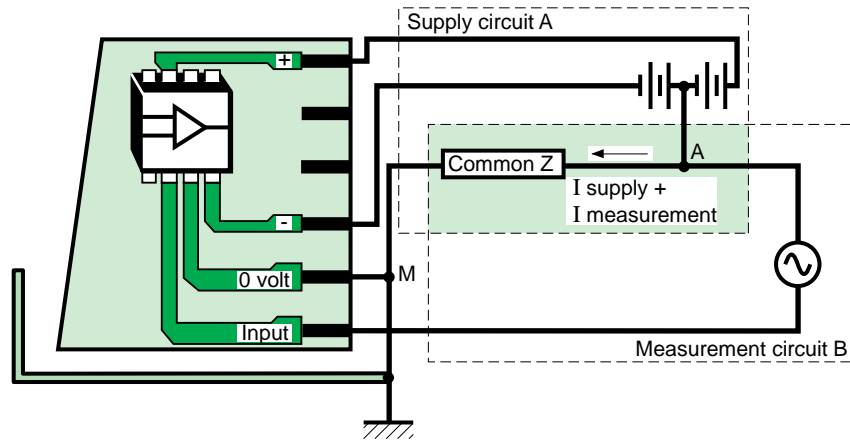

Fig. 13: The quantities measured by the operational amplifier will be incorrect because the disturbance current in circuit A (power supply) is high enough to create a disturbance voltage in circuit B (measurement).

As the name implies, common impedance coupling results from an impedance that is shared by two or more circuits. The common impedance can be the ground connection, the earth ground network, the power distribution network, the return conductor shared by several low power signals etc.

An example follows showing the effects of this type of coupling (see **fig. 13**). A disturbance current in circuit A in the tens of mA range is sufficient to generate disturbance voltages in the volt range in circuit B. If circuit B uses point M as its reference (possibly ground), then the reference can vary over several volts. This certainly influences integrated circuit electronics that work with voltages of the same order of magnitude.

The example shows that a common impedance can be formed by a wire a few meters in length and which is common to both circuits A and B.

The disturbance has a magnitude $U_c = I_a Z_c$ where:

- I_a is the disturbance current
- Z_c is the common impedance (see **fig. 14**)

At low frequencies the common impedance is usually extremely small. For example, safety requirements dictate minimum cross-sectional

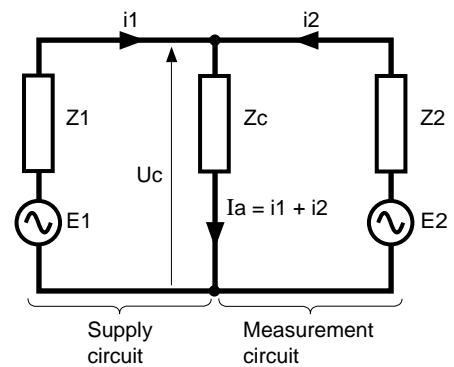

Fig. 14: Common impedance diagram

areas for the PE conductors, i.e. the green/yellow wires, of grounding networks depending on the prospective short-circuit current. The impedance at 50 Hz between two points in the network is therefore always much lower than 1Ω .

But that same impedance can be much larger at the typical frequencies of the disturbances discussed earlier. Impedances can reach several $k\Omega$ or more (see appendix 1).

3.4 Differential mode wire-to-wire coupling or crosstalk

Crosstalk is a mode of coupling that resembles the field-to-wire coupling. It is called capacitive or inductive crosstalk, depending on whether it is caused by a change in current or voltage.

A rapid voltage change between a wire and a ground plane or between two wires (see **fig. 15**) generates a field that can nearby, with some approximations, be considered an electric field only.

This field can couple into any other parallel wire-like structure. This is called capacitive crosstalk. Similarly, a current change in a wire or cable generates an electromagnetic field that with the same approximations can be considered a magnetic field only.

The field can couple into a pair of wires and induce a disturbance voltage. This is called inductive crosstalk (see **fig. 16**).

Capacitive and inductive crosstalk exists whenever conductors are routed in parallel or reside in close proximity to each other. Crosstalk can occur in cableways and troughs and especially between power cables carrying high-frequency disturbances differentially and twisted pairs used by digital networks such as Batibus. The crosstalk will be stronger the longer the parallel paths, the smaller the distance between wires or pairs of wires and the higher the frequency of the disturbances. For example, using the notation in **figure 15**, the voltage coupling coefficient (capacitive crosstalk) can be expressed as:

$$\frac{V_N}{V_1} = \frac{j 2\pi f \left[\frac{C_{12}}{C_{12} + C_{20}} \right]}{j 2\pi f + \left[\frac{1}{R (C_{12} + C_{20})} \right]}$$

where:

- V_1 : voltage source
 - V_N : disturbance voltage induced by coupling
 - C_{12} : coupling capacitance between two wires which is proportional to the wire length and the distance coefficient $\text{Log} [1 + (h/e)^2]$ where h is the distance between the two wires of the pair and e the distance between pairs
 - C_{20} : leakage capacitance between the two wires of the disturbed pair
 - R : load impedance of the disturbed pair
- In this formula, the first term in the denominator is often negligible as compared to the second term. Consequently a reasonable approximation would be:

$$\begin{aligned} \left| \frac{V_N}{V_1} \right| &\approx 2\pi f \frac{\frac{C_{12}}{C_{12} + C_{20}}}{\frac{1}{R (C_{12} + C_{20})}} \\ &= 2\pi f R C_{12} \\ &= \omega R C_{12} \end{aligned}$$

To be more specific, consider two pairs with wires of 0.65 mm diameter running 10 meters in parallel; the wires in the "victim" pair are 1 cm apart and the pairs 2 cm away from each other and $R = 1 \text{ k}\Omega$. For a 1 MHz signal, a coupling coefficient of - 22 dB is found, and further calculation gives the result:

$$\frac{V_N}{V_1} = \frac{1}{12}$$

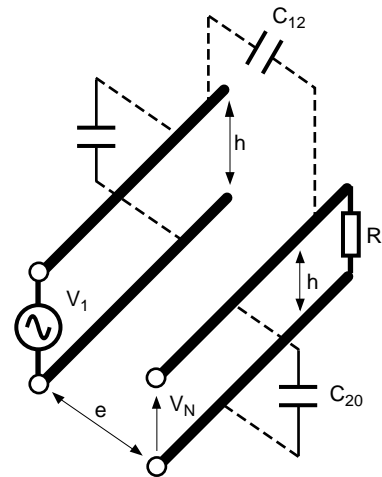

Fig. 15: A rapid change in V_1 creates a field which at a short distance can be assumed to be purely electric and induces a voltage V_N in another wire-like structure which runs in parallel; this mode of coupling is called capacitive crosstalk.

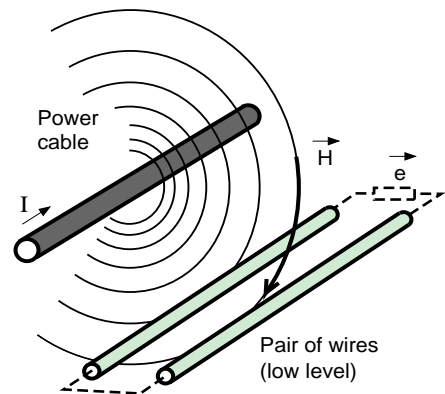

Fig. 16: A current change in the cable generates an electromagnetic field which at a short distance can be considered to be purely magnetic and induces a disturbance (voltage) in wires that form a loop; this mode of coupling is called inductive crosstalk.

In practice, capacitive and inductive coupling of this type is considerably reduced by the use of twisted pairs and shielded cables.

4 The victim

Any equipment that may be affected by a disturbance can be considered as a "victim". It is typically equipment containing some

electronics which malfunction because of electromagnetic disturbances occurring in an unexpected frequency band.

4.1 Equipment malfunction

Equipment malfunctions are divided into four categories and can be:

- permanent and measurable
- random and non-repetitive, appearing when the disturbances appear
- random and non-repetitive, remaining after the disturbances vanish
- permanent equipment failure (components physically destroyed)

The above types characterize the duration of the fault but not its severity.

The severity of a fault is a matter of functionality or, in other words how critical the equipment is. Certain malfunctions may be acceptable for a limited time such as the temporary loss of a display; others may not be acceptable such as security equipment malfunctions.

4.2 Solutions to the problem

Numerous solutions in terms of how equipment is to be built exist to provide effective and low-cost immunity to electromagnetic disturbances. Precautionary measures can be taken in:

- The design of printed circuit boards (functional partitioning, trace layouts, interconnects)
- The choice of electronic components
- The choice and design of protective covering
- The ground interconnections
- The wiring

The choices involve many different disciplines and should be made during the design phase of a project to avoid additional costs which are always high for modifications after the design is completed or when the product is already on the market.

Implementation of all these precautionary measures requires know-how which goes far beyond the standard filtering and shielding techniques often recommended to increase immunity even if their effectiveness has not been proven.

Printed circuit boards

The designer of printed circuit boards must follow certain rules that concern functional partitions and layout.

Starting with component placement, it is already possible to reduce coupling effects related to proximity.

For example, the grouping together of elements that belong to the same circuit category (digital, analog, or power circuits) according to their susceptibility, reduces interference.

Furthermore, the layout of circuit board traces (routing) has a dramatic effect on susceptibility: the same electrical schematic implemented in different ways can display orders of magnitude with different immunity levels. For example, a "minimum etch" circuit board layout (see [fig. 17](#)) reduces radiation effects and sensitivity.

Electronic devices

Numerous components are available to provide effective protection against conducted disturbances. Selection is guided by the power level of the circuit to protect (power supply, control and monitoring, etc.) and the type of disturbance. Consequently, for common mode disturbances in a power circuit, a transformer will be used if the disturbances are at low (< 1 kHz) frequencies and a filter if they are at high frequencies.

The table in [figure 18](#) gives a non-exhaustive list of protection devices. They have different characteristics: a filter does not protect against surges, and a surge protector does not protect against high frequency disturbances.

Shielding

Enclosing sensitive equipment in a conductive shield provides protection against electromagnetic fields. To be effective, the thickness of the conductive shield must exceed the skin depth at the frequencies of the disturbance encountered (see [fig. 19](#)). Against a high-frequency disturbance or an electric field, a conductive varnish can be efficient. Only a high-permeability material enclosure can stop low-frequency magnetic fields.

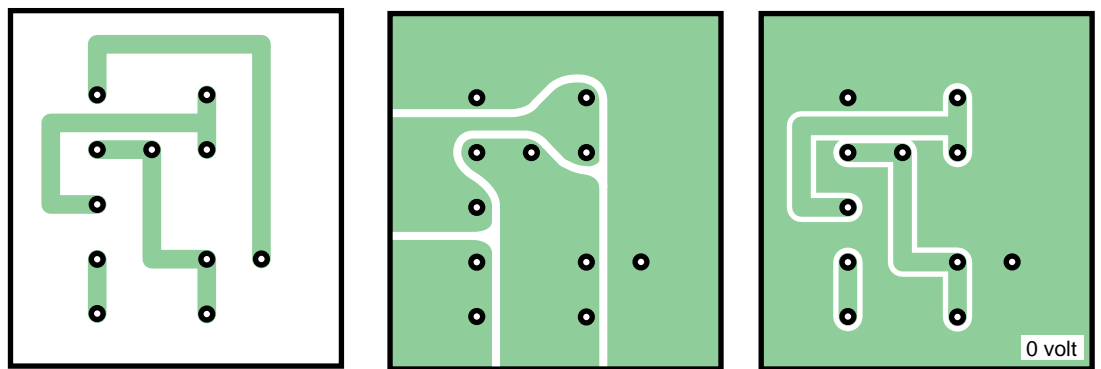

Thin circuit layout

Minimum etch layout

Layout with ground plane

Fig. 17: The circuit layout can reduce the electromagnetic susceptibility of a PCB: either by minimizing impedances (minimum etch), or by reducing the coupling of the electromagnetic field (ground plane).

Type	Device example	Applications
Surge arrester	Spark gap Lightning arrester Limiter	Power supply, control and monitoring ■ In installations
	Varistor Zener diode	■ Electronic circuits
Filtering	Transformer Inductor Capacitor Filter	Power supply, control and monitoring (installations and electronic circuits)
Shielding	Wire grid Door braid Shielded cable High frequency gasket Current finger	Data transmission (cabinet in disturbed area)

Fig. 18: List of protection devices

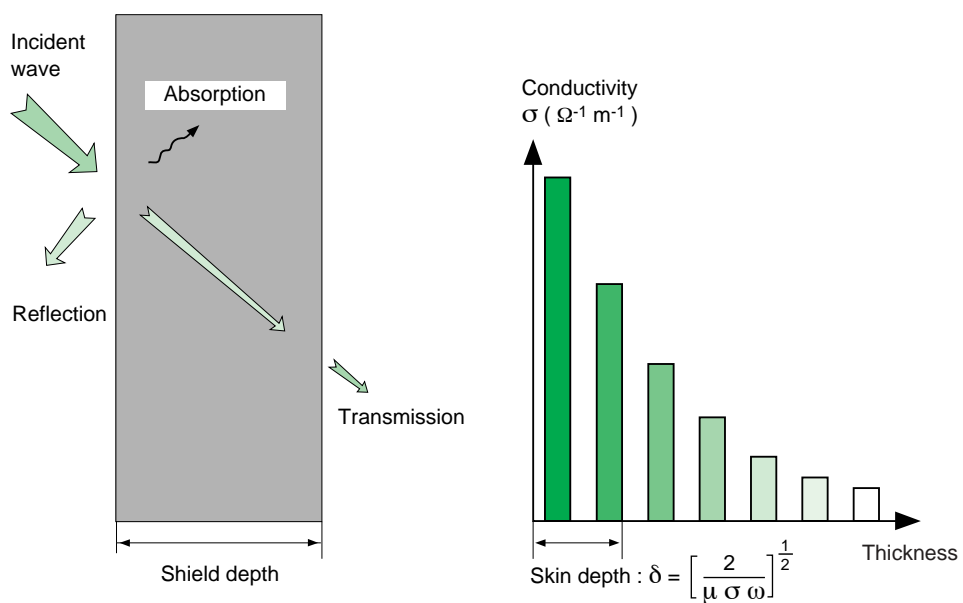

Fig. 19: Screening effect of a metal enclosure

Ground interconnections

When it comes to grounding, good electrical continuity between different parts of the housing is extremely important. They must be carefully and correctly interconnected, for example protecting contact areas from any paint and also by using short, wide wire braids (to reduce impedance to a minimum).

Cabling

Cable shielding is an extension of the conductive envelope placed around sensitive systems. It therefore has the shortest possible connection and if possible all around its perimeter to protect against high-frequency disturbances.

Just as with the coupling between an electromagnetic field and a wire-like structure (see section 3), the theory governing wire shielding is very complex and too vast to be covered in this paper. References to special literature are given in the bibliography.

When all design and manufacturing rules are respected, the system will be sufficiently immune to electromagnetic disturbances in the environment it was built for.

Nevertheless, this immunity can only be validated by actual measurements that determine the effectiveness of different shielding techniques. At Schneider Electric, for example, different prototype models of electronic trip units for circuit breakers are exposed to rigorous tests representative of the largest disturbances to which they are likely to be subjected.

The true objective of these tests is to check that the trip unit does not operate inadvertently and that the circuit breaker opens correctly and in the required time.

The "product" standards now include these specifications, for example: IEC 60947-2 standard concerning industrial circuit breakers, and a revised IEC 61131-2 concerning programmable logic controllers.

5 Installation

5.1 Installation is an important factor in the overall system EMC

Evidence of this fact can be found in the NF C 15-100 (IEC 60364) general LV installation standards which devotes an entire chapter (33) to electromagnetic compatibility.

The two previous sections have shown that installation plays an important role in EMC; this is true for both the design and layout phase and the actual installation phase.

5.2 Design phase

During the design and layout phase two major factors govern EMC: the choice of equipment and their relative locations (see **fig. 20**).

The first factor concerns the choice of both emitters and victims: a given piece of equipment can to some extent generate disturbances and/or be susceptible.

For example, if two units are to operate close to each other they must:

- Either combine an emitter that generates low levels of disturbance and an "ordinary" (i.e. not overly sensitive) victim.

- Or combine an "ordinary" emitter that generates moderate levels of disturbance and a low-sensitivity victim.

- Or form a compromise between the above two extremes.

The second factor that depends directly on the first concerns the positioning of equipment, already selected with respect to their individual characteristics, to satisfy EMC requirements. It is obvious that this selection must take into account the cost of equipment and of its installation.

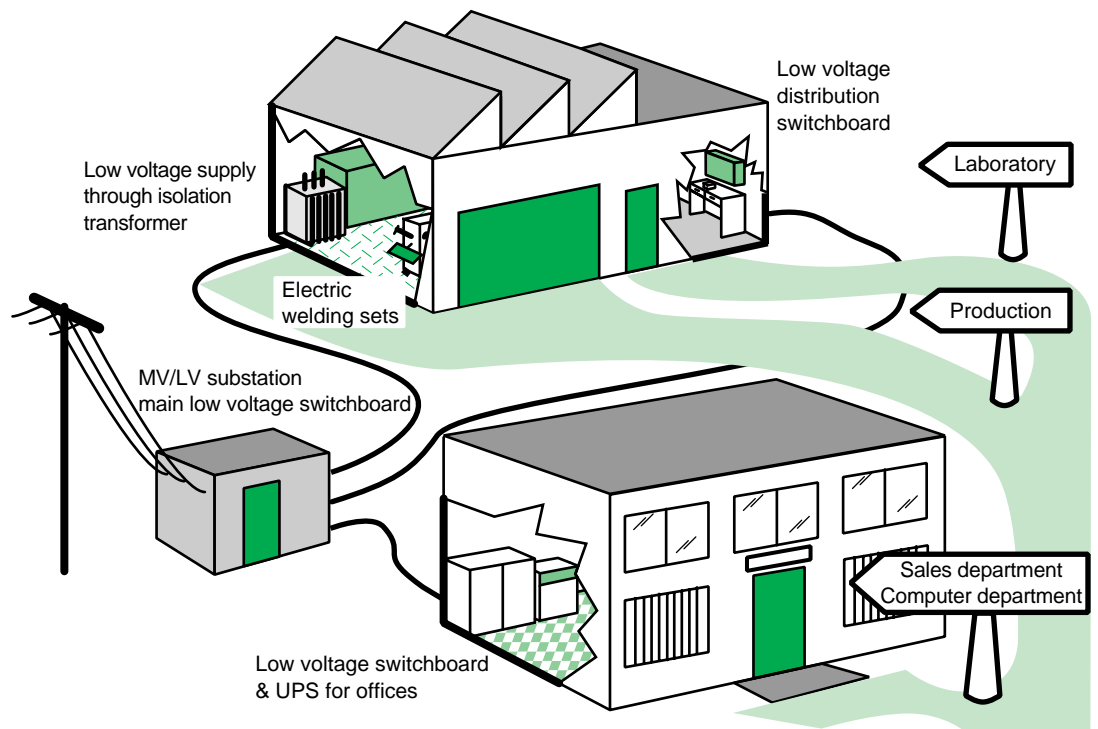

Fig. 20: Example of electrical equipment layout respecting EMC

5.3 Installation phase

Electrical and electronic installation work should follow the guidelines already discussed in previous sections. In practice, the different coexistent coupling modes must be studied and reduced to satisfy the EMC requirements.

Different techniques should be applied:

- The circuits and the chassis/earth grounds must be laid out in a grid.
- The circuits must be physically separated.
- The wiring must be carefully planned.

5.4 Practical examples

Grid layout for circuits and chassis/earth grounds

Today, equipment can be susceptible to very low energy levels. It contains interconnected electronics sensitive to high frequencies. Common impedance coupling frequently occurs and to avoid it, the best possible equipotential grounding system or to be more precise a ground grid, is essential.

This is the first step in providing protection against disturbance problems. In a factory power distribution network, all protection (PE) wires must be joined together and connected to the existing metal structures as specified in NF C 15-100 (see [fig. 21](#)).

Similarly, within equipment, all grounds and frames must be connected to a grid-like grounding system in the shortest possible way using low impedance (at high frequencies), wide and short electrical connections (wires or braids). The wiring of an electrical cabinet is a typical example: all grounds must be connected together.

There is a change to be noted here: the method involving the connection of all grounds to a central point (star configuration), sometimes used for analog electronic equipment sensitive to 50 Hz hum, has been replaced by grids which are far more effective in reducing disturbances that affect today's digital systems, protection relays and control and monitoring systems.

Separation of electrical circuits

This technique consists of separating the energy sources (usually 50 or 60 Hz). The aim is to avoid interference on a sensitive device caused by conducted disturbances generated by other systems connected to the same power source. The principle is to create two separate power sources isolated by impedances that are high at the frequency of the disturbances.

Transformers (not auto-transformers) are effective isolators, especially at low frequencies: MV/LV transformers, isolation transformers and any input transformer for electronics stop conducted disturbances.

Sometimes an isolating filter is required to eliminate high frequency disturbances. If the sensitive equipment also requires emergency power, it can be supplied by an uninterruptible power supply (UPS) as long as the UPS contains the required isolation transformer(s).

Well-designed wiring

The effects of the three coupling mechanisms discussed earlier can be reduced if the wire and cable routing adheres to the following rules:

- In all systems that cannot be separated physically for economic reasons, wires/cables must be grouped together by category. The different categories should be routed separately: in particular, power cables should be on one side

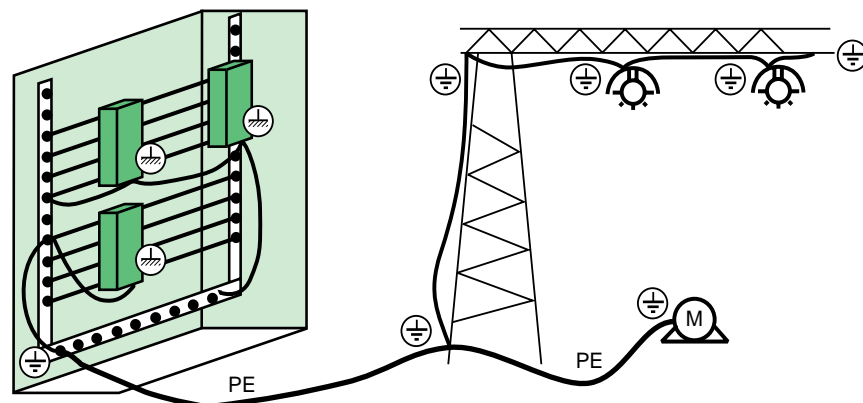

Fig. 21: The grids for circuits and for chassis/earth grounding systems are often combined in electrical cabinets

and low-power cables (telephone, control and monitoring) on the other (see **figure 22**).

If a sufficient number of cableways or troughs are available, power cables carrying more than a few amperes at 220 V should be routed separately from the low-power signal cables. Otherwise, a minimum distance of at least 20 centimeters must be kept between the two.

Any element common to these two categories of cable must be avoided.

Circuitry using low-level signals should have, whenever possible its own return wire (0 Volts) to avoid common impedance coupling. The majority of systems that communicate over buses require pairs of wires reserved exclusively for data exchange.

- In any case, the overall loop area formed by the conductor and its return must be minimized. In data transmission, twisted pairs reduce the susceptibility to differential mode coupling. The twisted pair is to be preferred over straight wires.
- Cables used for measurements and low signal level data transmission should be shielded, if possible, and in the absence of specific

instructions from the manufacturer, their shield should be connected to ground at a maximum number of points.

- The cable routing troughs should, if at all possible, be made out of metal. The troughs should be correctly electrically interconnected, e.g. screwed together and connected to the grounding grid.

■ The most sensitive cables (e.g. those used in measurements) should be placed in the corner of the trough where they can benefit from maximum protection against electromagnetic radiation. Their shielding, if any, should be connected to the trough at regular intervals.

The use of prefabricated cable trunking assemblies in which the cables are positioned and connected correctly, such as Telemecanique's Canalis system with built-in control wires, is highly recommended.

All these cabling techniques, which effectively avoid EMC problems, only increase costs slightly when applied at design or installation time. Later modifications of an existing installation showing excessive electromagnetic coupling are far more expensive.

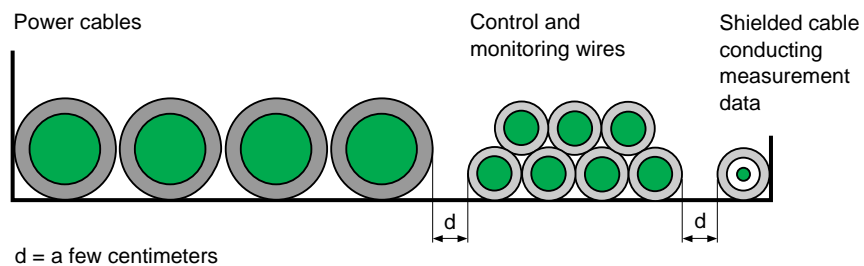

Fig. 22: Example of cable routing

6 Standards, test facilities and tests

6.1 Standards

Documented standards that regulate electromagnetic compatibility of systems have long been in existence.

The first regulations were issued by the CISPR, Comité International Spécial des Perturbations Radioélectriques (International Special Committee on Radio Interference). These regulations covered only the maximum acceptable power level that could be emitted by different types of equipment, mainly to protect radio transmission and reception.

National Committees and the International Electrotechnical Commission (IEC) have issued documented standards that cover all aspects of EMC emission and susceptibility encountered in the civilian domain.

Military standards on EMC have been compiled in the GAM EG 13 series in France and in the MIL-STD series in the United States.

The increasing importance of EMC and the forthcoming unification of Europe are changing the landscape of civilian standards.

The European Council published a Directive (reference 89/336/EC) in May 1989 on this subject. It relates to unifying the EMC legislation of the member countries. Every member country is committed to include it in its national legislation and make its use and application mandatory.

The European Directive not only imposes limits on emitted disturbances but also sets the minimum immunity to electromagnetic disturbances. The Directive makes reference to standards that define maximum disturbance levels.

Technical Committees were established by CENELEC, Comité Européen de Normalisation Electrotechnique (European Committee for Electrotechnical Standardization). They gathered existing standards which correspond to application of the Directive, and drew up those

standards which were missing. The Technical Committee TC 210 based its work on actual industrial practice.

For emission tests, the German standards VDE 0871 and VDE 0875 were used for some time as a reference. These are now replaced by the recent European standards EN 55011 and EN 55022. The reference standards for EMC are now the IEC 61000 series (formerly IEC 1000). The publication contains several parts, for example:

- 61000-1: Application, definitions
- 61000-2: Environment, compatibility levels
- 61000-3: Disturbance limits
- 61000-4: Testing and measuring techniques
- 61000-5: Installation and mitigation guidelines
- 61000-6: Generic standards

Part 4 contains several sections relating to immunity tests, including:

- 1 - Overview of immunity tests
- 2 - Electrostatic discharge
- 3 - Radiated, radio-frequency electromagnetic fields
- 4 - Electrical fast transient/bursts
- 5 - Surges
- 6 - Conducted disturbances > 9 kHz
- 7 - Harmonics
- 8 - Power frequency magnetic fields
- 9 - Pulse magnetic fields
- 10 - Damped oscillatory magnetic field
- 11 - Voltage dips, short interruptions and voltage variation
- 12 - Oscillatory waves
- 13 - Harmonics and interharmonics
- etc.

These standards are widely accepted in the international community and Schneider Electric has adopted them for its products. The following section describes in more detail the tests that relate to these standards.

6.2 Test facilities

As mentioned before, to respect regulations, standardized measurements and tests must also be performed.

Due to its business applications, Schneider Electric made EMC one of its major concerns

long ago. Large installations such as Faraday cages have been in use since the seventies.

For many years, Schneider Electric has had two EMC laboratories. These centers make full use of our skills and knowledge and promote the

exchange of information. They also offer services to outside customers. Thus the conducted tests cover a wide range of EMC applications, with:

- electrostatic discharge tests
- conducted and radiated immunity tests
- conducted and radiated emission tests

As with any other measurements, electromagnetic compatibility measurements must be reproducible both in time and in space, which means that two measurements performed

at two different laboratories must yield the same results. In the EMC discipline, this means large facilities requiring considerable investment and a strict quality policy.

The quality program at the Schneider Electric EMC laboratories is based on a Quality Manual and a set of procedures. These procedures concern calibration and the connection to calibrated standards in addition to each type of measurement itself. The list of tests for standards that can be performed at the laboratories appears in appendix 3.

6.3 Tests

Electrostatic discharge

These tests are designed to check the immunity of circuit boards, equipment and systems to electrostatic discharge.

Electrostatic discharges are the result of charges accumulated by a person, for example, walking on a floor covered with an electrically insulating material. When the person touches an electrically conducting material connected via an impedance to ground, he discharges suddenly through the impedance. Several studies have shown that the waveform is a function of the characteristics of the emitter (the source of the discharge) and of the circuits involved, but also of other parameters such as relative humidity (see [fig. 23](#)) or the speed at which the charged body approaches, in our example the hand of the person, etc.

This research has led to standardized discharge tests. They are performed with an electrostatic gun that simulates a human being in predetermined configurations (see [fig. 24](#)).

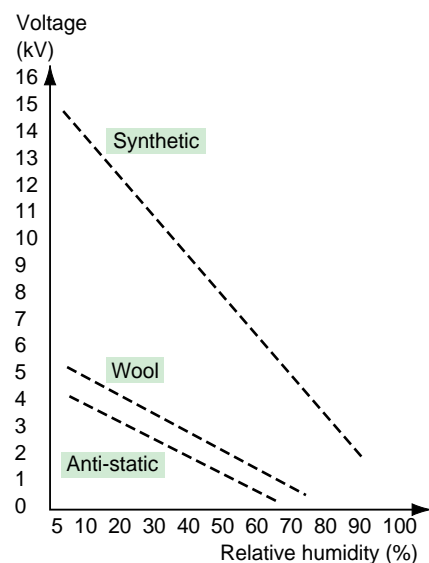

Fig. 23: The effect of relative humidity on the electrostatic discharge voltage for three types of floor materials

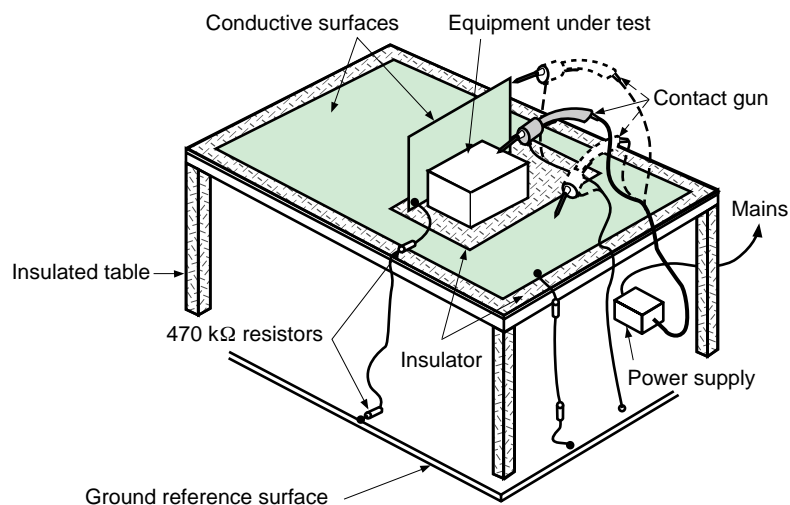

Fig. 24: Electrostatic discharge test site as defined by standard IEC 61000-4-2

Discharges are applied on all accessible parts of the device under test, in its immediate environment and repeated a sufficient number of times to make sure that the device resists electrostatic discharge.

These measurements require an appropriate test bench.

All tests are completely defined by standard IEC 61000-4-2 with severity levels shown in the table of **figure 25**.

Conducted immunity

Immunity tests are used to verify the resistance of equipment to disturbances reaching it via external equipment cables (inputs, outputs and power supply). As mentioned before, these disturbances differ depending on the type and installation characteristics of the cable. The electromagnetic signals or pulses used in these tests have characteristic amplitudes, waveforms, frequencies etc.

Disturbance measurements performed on numerous sites have led to the selection of five tests.

■ The first test, covered by IEC 61000-4-4, simulates typical disturbances generated by the operation of control gear. The test uses bursts consisting of a number of fast transients. The burst repetition frequency is approx. 3 Hz. Each burst contains approx. 100 transients every 100 μ s. Each transient rises steeply (5 ns) to an amplitude of several kV, depending on the required severity level (see **fig. 26** and **27**).

All cables can be subjected to fast transients. This type of disturbance couples into wiring very easily e.g. crosstalk (see the chapter on "coupling"). It takes only one cable generating such disturbances in a cable or wire trough to pollute all other cables running along the same path. The test must therefore involve all cables and wires: a common mode test is performed on all wires with artificially induced disturbances (cables other than the power supply) and a common and differential mode test on cables

Severity level	Tests voltage (kV), $\pm 10\%$	
	Air discharge	Contact discharge
1	2	2
2	4	4
3	8	6
4	15	8

Fig. 25: Electrostatic discharge voltages that devices must withstand to comply with standard IEC 61000-4-2

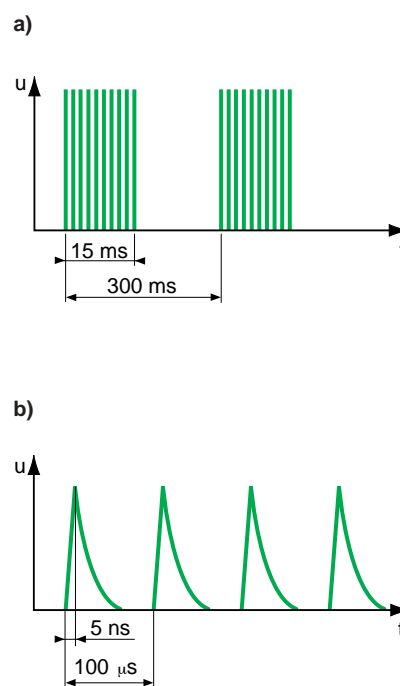

Fig. 26: Shape of the bursts (a) and their fast transients (b)

Severity level	Applied test voltage ($\pm 10\%$) in kV without malfunctions occurring (open circuit output)	
	On power supply	On input/output lines (signal, data, control)
1	0.5	0.25
2	1	0.5
3	2	1
4	4	2
x	Special	Special

Level x is defined contractually between manufacturer and client.

Fig. 27: Table of severity levels defined in IEC 61000-4-4

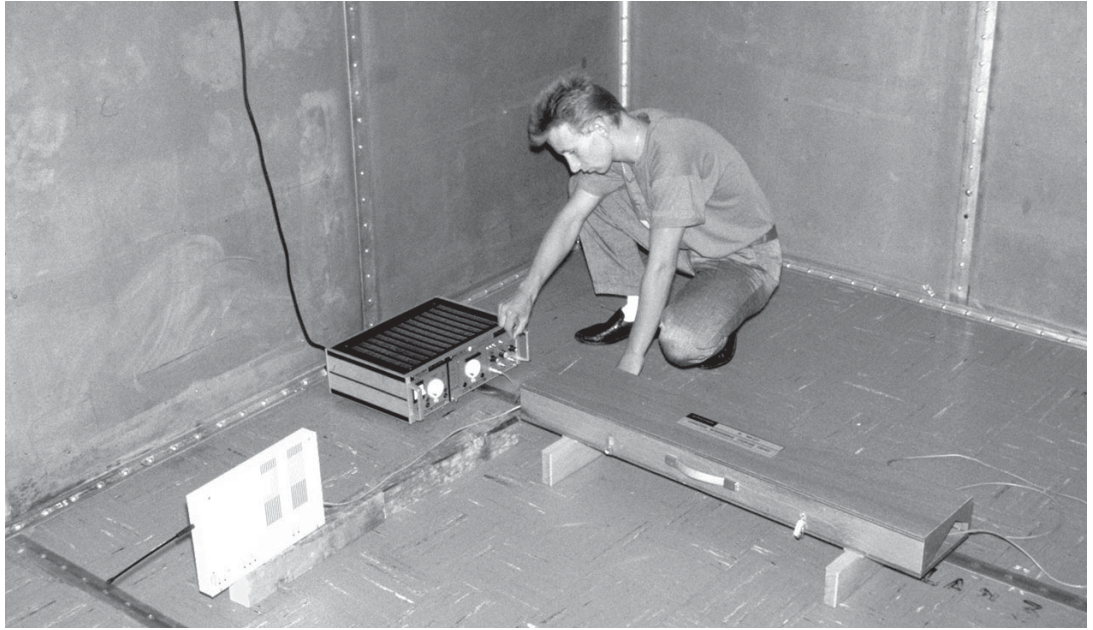

Fig. 28: Susceptibility to fast transients, measured on an Isis master control unit (test 61000-4-4) in a Faraday cage. This photo shows the disturbance generator being adjusted by an operator, the wooden case containing the coupling clamp and the Isis master control unit connected to the Batibus network.

connected to the mains. Disturbances are injected into the tested cables either via direct capacitive coupling (power supplies), or via a coupling clamp consisting of two metal plates that enclose the secondary cables (see **fig. 28**).

The equipment under test must not show a malfunction over a predetermined period (1 min). This test is the most relevant one for device immunity because fast transients are the most frequent ones encountered.

■ The second test is representative of secondary effects created by phenomena such as lightning. It simulates conducted disturbances appearing on LV power lines after lightning strikes (standard IEC 61000-4-5).

These disturbances consist of energy that is transformed into:

- Voltage impulses 1.2/50 μ s, if the impedance of the tested device is high, with amplitudes that can reach several kV. Test voltages are indicated in **figure 29**
- Current impulses 8/20 μ s if the impedance is low, with amplitudes reaching several kA

The rise time of this type of disturbance is in the order of a thousand times longer, in the microsecond range, than for bursts of fast transients (see **fig. 26**). Crosstalk type of coupling is therefore less prevalent and this second type of test only applies to cables directly connected to the mains. The common and differential mode tests use capacitive coupling and appropriate levels. The procedure resembles the fast transients test: the equipment under test must not malfunction.

Severity levels	Test open-circuit output voltage (kV)
1	0.5
2	1
3	2
4	4
x	Special

Level x is defined contractually between manufacturer and client.

Fig. 29: Severity levels as defined in IEC 61000-4-5 (generator impedance = 2 Ω)

■ The third test is performed according to IEC 61000-4-6. It deals with requirements concerning immunity of equipment to HF disturbances on the cables, in the range 150 kHz to 80 MHz (even 230 MHz). The disturbance sources are electromagnetic fields which can stress the whole length of the cables connected to these equipment, and induce voltages and currents thereto.

During the test, the disturbances are coupled to the cables via Coupling-Decoupling Networks (CDN) the common mode impedance of which, equal to 150 Ω , represents the characteristic impedance of most of the cables. However, it should be pointed out that during the test, the disturbances are applied to one cable at a time, though in reality the electromagnetic field couples to all the connected cables. This constitutes a significant difference which cannot

be avoided. Indeed the test should be very complex and expensive if HF signals were coupled to all the cables simultaneously.

If CDNs are not suitable, for example when the current is too high, use coupling clamps.

The HF disturbances recommended by the standard IEC 61000-4-6 have levels equal to 1, 3 or 10 V. Their amplitude is modulated at 80% by a 1 kHz sine wave.

Prior to the test, the signal to be injected to obtain the right level is calibrated and stored, then applied to the cables connected to the equipment under test.

■ The fourth test consists of creating fleeting interruptions and/or voltage dips on the power supply cables of the equipment under test. Standard IEC 61000-4-11 is the basic reference publication.

These disturbances are caused by faults in the mains supply, the installation or by sudden major changes in the load. These random phenomena are characterized both by their deviation from the rated voltage and their duration.

The voltage dip levels are 30, 60 or 100% (breaking) of the rated voltage. Their duration varies between 0.5 and 50 periods.

■ The fifth test is conducted in accordance with standard IEC 61000-4-12, which defines two types of waveform:

□ Damped sine waves (also known as "ring waves") which appear in isolation on low voltage cables of public or private networks following switching operations

□ Damped oscillating waves which appear in the form of bursts. These are generally found in substations, power stations, or even large industrial installations, especially following operation of disconnectors accompanied by arc reignition.

The transient voltages and currents resulting from these operations appear on the busbars and are characterized by an oscillation frequency that depends on their lengths and propagation times. This frequency varies between 100 kHz and a few MHz for open high voltage substations, and can reach as high as ten MHz, or even more, for shielded high voltage substations.

During the tests, the waves are coupled to the cables via coupling-decoupling networks. Depending on the injection method, the amplitude of the disturbances can vary between 0.25 and 4 kV. "Table-top" devices are placed on

a post isolator, whereas "floor-standing" or "enclosed" devices are isolated from the ground plane by a distance of 0.1 m.

Immunity against radiated emission

The immunity tests against radiated emissions were devised to ensure the satisfactory operation of equipment when exposed to electromagnetic fields.

Since these tests are particularly environment-sensitive, the means deployed and competency levels required to produce reliable and reproducible immunity measurements are very high.

The surrounding environment must be sufficiently "clean" and free of waves normally present, since (as discussed in the "source" section) electromagnetic fields with strengths in the several V/m range are frequent (e.g. two-way portable radios) and pulsed electromagnetic fields with even higher levels are common in industrial environments. These tests must therefore be conducted in Faraday cages with walls covered by high frequency absorbing materials. These cages are called anechoic chambers when all walls including the floor are covered and semi-anechoic when the floor is not.

In the chambers, fields are generated by different types of antennae depending on the type of field, the frequency range and polarization (see [fig. 30](#)). The antennae are driven by a wideband power amplifier controlled by an R.F. generator.

The generated fields are calibrated using broadband isotropic sensors (field strength monitors). The diagram in [figure 31](#) shows a typical test setup.

Standards define the acceptable disturbance limits. Hence, standard IEC 61000-4-3 recommends tests on the 80 MHz – 2000 MHz frequency band with three severity levels (1, 3, 10 V/m), and on the 800 MHz – 960 MHz and 1.4 GHz – 2 GHz bands with four severity levels: 1, 3, 10 and 30 V/m.

Tests of immunity to magnetic fields at mains frequency are also conducted in accordance with standard IEC 61000-4-8. Such magnetic fields are generated by the current circulating in the cables, or less commonly by other devices located nearby, such as the leakage flux from transformers.

The permanent field test levels have currents of between 1 and 100 A/m, whereas those of the short-duration fields – 1 to 3 s – have currents of

300 or 1000 A/m. The magnetic field is obtained by a current circulating in an induction coil. It is applied to the equipment under test according to the immersion method, i.e. it is placed at the center of the coil. This test should only be conducted on equipment with components that

are sensitive to magnetic fields (CRT screens, Hall-effect sensors, etc.). Standardized measurements for pulsed electromagnetic fields do not yet exist. In this domain, Schneider Electric uses its own internal procedures to test equipment.

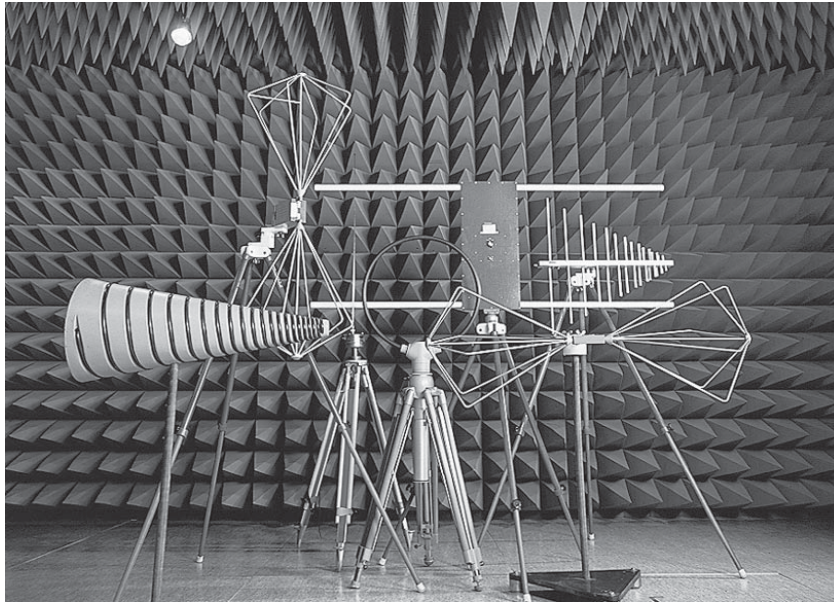

Fig. 30: Faraday cage: semi-anechoic chamber and several antennae of an EMC laboratory at Schneider Electric

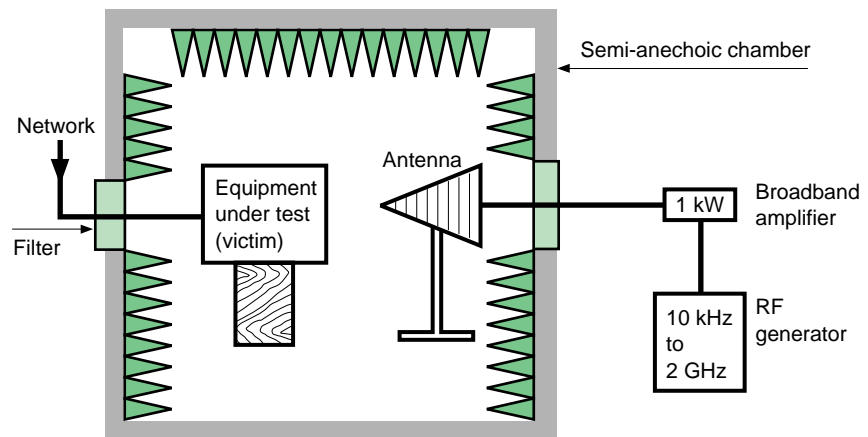

Fig. 31: Typical test setup in a Faraday cage. Measurements are performed in two stages:
 1 - Calibration of the field for a given frequency range, without the EUT (equipment under test)
 2 - Verification of the EUT immunity

Conducted emission

Conducted emission measurements quantify the disturbances that the equipment under test re-injects into all cables connected to it. The disturbance strongly depends on the high-frequency characteristics of the load connected to it since the equipment under test is the generator in this case (see [fig. 32](#)).

To obtain reproducible measurement results and especially to avoid problems with the characteristic impedance of the network, the conducted emission measurements are performed with the help of a Line Impedance Stabilizing Network (LISN). A high-frequency receiver is connected to the network to measure emission levels at each frequency.

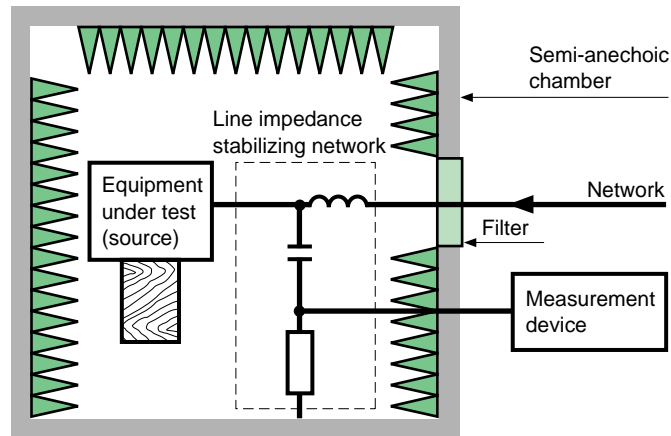

Fig. 32: Measurement configuration for conducted emissions. The EUT is the generator, the line impedance stabilizing network is the load.

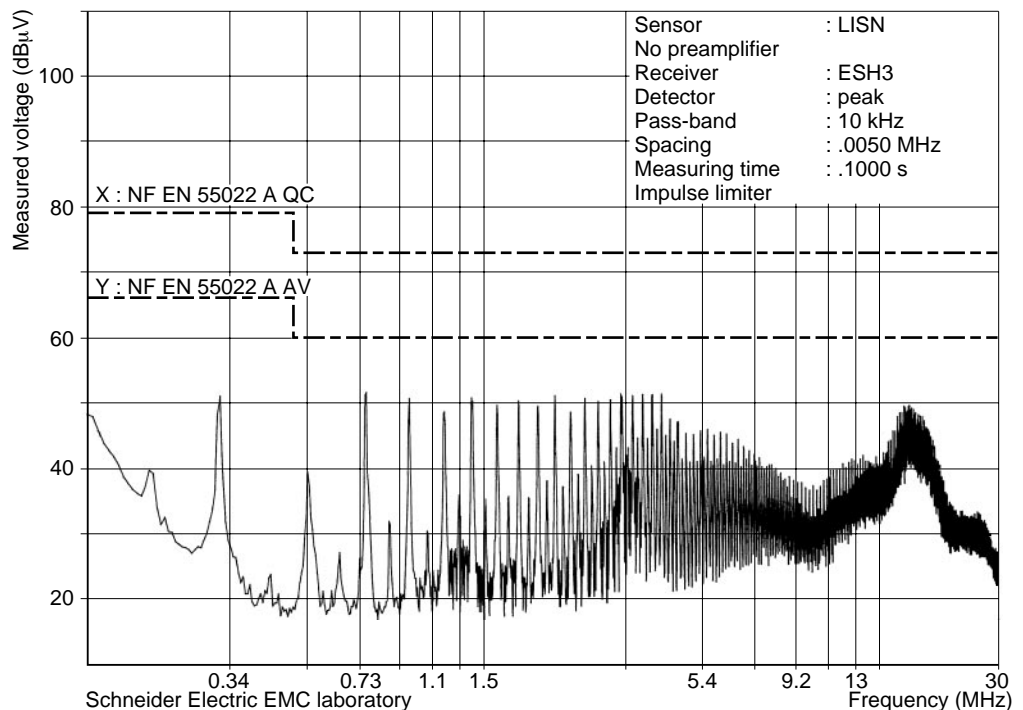

Fig. 33: Measurements of radio frequency emissions from a central data processing unit of a main switchboard.

The level of disturbances re-injected should not exceed the limits defined in the standards. These limits depend on the type of cable and the environment. The graph below (see [fig. 33](#)) shows the results of a measurement performed on a main LV switchboard and the levels defined in standard EN 55 022 for comparison.

Radiated emission

Radiated emission measurements quantify the level of disturbance emitted by a device in the form of electromagnetic waves.

Just as with radiated immunity tests, radiated emission tests must be performed in the absence of waves normally present such as CB, radio etc. and must not be modified by reflections from surrounding objects. These two conditions are contradictory and this is the reason for the existence of two test methods. The first method consists of placing the EUT in a field free of obstacles within a given perimeter. The environment is uncontrolled.

The second method is implemented in a Faraday cage; the reflections from the walls are deliberately attenuated by high frequency absorbing materials (see [fig. 30](#)). The environment can be perfectly controlled.

The Schneider Electric laboratories use the second method. It offers a key advantage in that measurements can be automated and also equipment handling is minimized, since emission

and immunity level measurements can be performed at the same site with just few setup changes.

As for conducted emissions, the emission levels must be less than the limits set by specifications or standards.

Measuring pulsed fields

Standardized tests are performed to measure emission levels or test the immunity of devices or systems to the most common types of electromagnetic disturbances encountered in an industrial environment.

However, the environment for devices developed by Schneider Electric has certain characteristics not yet covered by standards.

For example, specific EMC test procedures for equipment in medium voltage substations do not yet exist.

This is why Schneider Electric performs a series of measurements to better understand the typical disturbances that exist in the vicinity of the equipment it manufactures, especially near low, medium and very high voltage switchgear.

In a second phase, in-house tests using special test systems have been developed. They allow testing of the electromagnetic compatibility of devices without having to revert to full-scale tests. These tests are easier to reproduce and less costly. They are performed early in the design which minimizes the costs of EMC protection.

7. Conclusion

The use of electronics in a large number of applications, and especially in electrotechnical equipment, has introduced a new and important requirement: electromagnetic compatibility (EMC). Trouble-free operation in disturbed environments and operation without producing disturbances are essential to product quality requirements. To achieve both these goals, the complex phenomena involved in the sources, coupling and victims must be well understood. A certain number of rules must be followed in the design, industrialization and manufacture of products.

The site and installation characteristics also play an important role in electromagnetic compatibility.

This explains the importance of carefully considering the location and layout of power components, cable routing, shielding etc. right from the initial design phase. Even if equipment offers satisfactory EMC, a well designed installation can extend the compatibility safety margins.

Only measurements requiring a high level of expertise and sophisticated equipment can produce valid results quantifying the electromagnetic compatibility of equipment.

Compliance with standards therefore provides the certainty that equipment will operate satisfactorily in its electromagnetic environment.

Appendix 1: Impedance of a conductor at high frequencies

The level of EMC in equipment depends on coupling between circuits. Coupling is directly related to the impedance between circuits, especially at high frequencies. To improve EMC, these impedances must be determined and then reduced.

A few approximating formulae exist to determine the high-frequency impedance of typical conductors. These formulae are cumbersome and their results meaningless if the exact position of all involved elements is unknown. But who knows the exact position of a wire with respect to the others in a cable trough? The answers to this and similar questions come from experience together with basic knowledge of the theory of electrical phenomena.

First of all it is important to keep in mind that the impedance of a conductor is mainly a function of its inductance and becomes preponderant starting at a few kilohertz for a standard wire. For a wire assumed to be infinitely long, the inductance per unit length increases logarithmically with the diameter, therefore very slowly: for wires that do not exceed 1/4 of the

disturbance wavelength, an inductance of one $\mu\text{H}/\text{m}$ can be used irrespective of the diameter (see [fig. 34](#)).

This value is much lower when the wire is correctly run against a conductive plane. It becomes a function of the distance between the wire and the plane and the inductance can easily be decreased by 10 dB. At very high frequencies the wire must be considered as a transmission line with a characteristic impedance of around one hundred ohms.

In this light, a common inductance of several μH can easily be created, for example, with a few meters of green-yellow (grounding) wire. This translates into a few ohms at 1 MHz and a few hundred ohms at 100 MHz.

Conclusion: A conducting metal plate represents the electrical interconnect offering the lowest impedance, independent of thickness as long as it is greater than the skin depth ($415 \mu\text{m}$ at 10 kHz for copper). A copper plate displays an inductance of 0.6 nH (at 10 kHz) and an impedance of $37 \mu\Omega$ per square (the impedance remains the same irrespective of the surface).

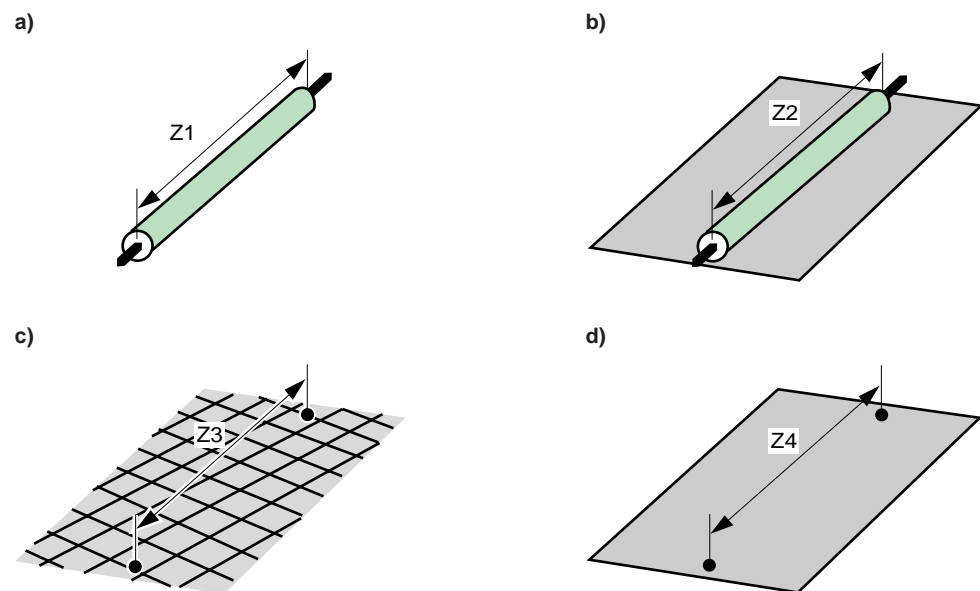

Fig. 34: At equal lengths, the different impedances:

a: cable in air ($L \approx 1 \mu\text{H}/\text{m}$)

b: cable placed on a metal surface

c: metal grid with electrical contact at each node (e.g. welded concrete reinforcing bars)

d: metal surface

have a per unit length impedance $Z1 > Z2 > Z3 > Z4$.

Appendix 2: The different parts of a cable

The technical terms used to describe different parts of a cable can have slightly different meanings depending on the cable's field of application (power transmission, telephone, data or control and monitoring) (see **fig. 35**).

The IEC definitions are in italics.

Jacket: The jacket's most important role is to protect the cable from mechanical damage. That is why it usually contains two helically stranded soft steel bands.

For data transmission cables, it also serves as an electrostatic and more often an electromagnetic shield.

Shield: *Same as a screen; i.e. device designed to reduce the intensity of electromagnetic radiation penetrating into a certain region.*

A jacket or screen of a cable, whether for power or data transmission, can form a shield.

Screen: *A device used to reduce the penetration of a field into an assigned region.*

It has multiple functions:

- Creation of an equipotential surface around the insulator

- Protection against the effects of external and internal electrostatic fields

- Draining the capacitive current as well as earth leakage fault currents (zero sequence short-circuits)

- Protection of life and property in the event of a puncture. For this reason, it is generally made of metal and is continuous (lead tubing, braided wire, helically wound bands).

For cables carrying data, the screen, more often called a shield, consists of copper or aluminium wire bands or braids, wrapped around to form a shield against electrostatic or electromagnetic fields.

It can be an overall shield, for all conductors in the cable, when the disturbances are external to the cable.

It can also be partial, for a limited number of conductors, to protect against disturbances emitted by the other conductors in the cable.

Insulator: The insulator renders the cable water and/or air tight.

Telephone cable

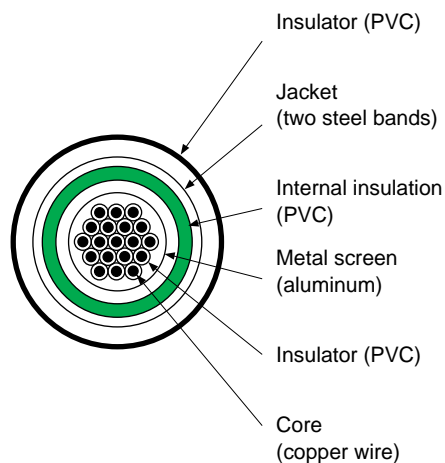

Medium voltage power transmission cable

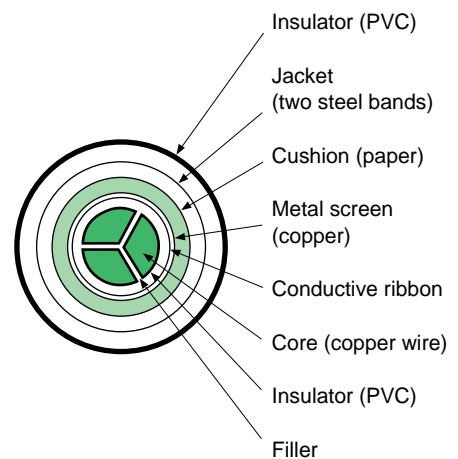

Fig. 35

Appendix 3: Tests performed at Schneider Electric EMC laboratories

The EMC laboratories of Schneider Electric have the necessary equipment and expertise to perform tests in accordance with a large number of standards or specifications.

The laboratory clients, whether internal or external to the Company, can benefit from the experience of the laboratory staff in finding the

right standards applicable to their product, and also to determine the functional acceptability criteria according to standards relative to the product, if they exist, otherwise according to functional requirements relative to safety, continuity of service, comfort, etc.

Standardized tests

Giving a complete list of all the test standards would be tedious and inevitably incomplete due to the rapid evolution in the publication of product test standards. We therefore indicate hereafter the main reference standards regarding the performance of EMC tests. Local EMC standards exist in many countries. The EEC countries have generally issued local standards equivalent to the following IEC standards.

Immunity

- IEC 61000-4-2 (= EN 61000-4-2)
Electromagnetic compatibility (EMC)
Part 4-2: Testing and measurement techniques - Electrostatic discharge immunity test
- IEC 61000-4-3 (= EN 61000-4-3)
Electromagnetic compatibility (EMC)
Part 4-3: Testing and measurement techniques - Radiated, radio-frequency, electromagnetic field immunity test
- IEC 61000-4-4 (= EN 61000-4-4)
Electromagnetic compatibility (EMC)
Part 4-4: Testing and measurement techniques - Electrical fast transient/burst immunity test
- IEC 61000-4-5 (= EN 61000-4-5)
Electromagnetic compatibility (EMC)
Part 4-5: Testing and measurement techniques - Surge immunity test
- IEC 61000-4-6 (= EN 61000-4-6)
Electromagnetic compatibility (EMC)
Part 4-6: Testing and measurement techniques - Immunity to conducted disturbances, induced by radio-frequency fields
- IEC 61000-4-8 (= EN 61000-4-8)
Electromagnetic compatibility (EMC)
Part 4-8: Testing and measurement techniques - Power frequency magnetic field immunity test
- IEC 61000-4-11 (= EN 61000-4-11)
Electromagnetic compatibility (EMC)
Part 4-11: Testing and measurement techniques - Voltage dips, short interruptions and voltage variations immunity tests

- IEC 61000-4-12 (=EN 61000-4-12)
Electromagnetic compatibility (EMC)
Part 4-12: Testing and measurement techniques - Oscillatory waves immunity test
- IEC 61000-6-1 (=EN 61000-6-1)
Electromagnetic compatibility (EMC)
Part 6-1: Generic standards - Immunity for residential, commercial and light-industrial environments
- IEC 61000-6-2 (=EN 61000-6-2)
Electromagnetic compatibility (EMC)
Part 6-2: Generic standards - Immunity for industrial environments

Emission

- CISPR 11
Industrial, scientific and medical (ISM) radio-frequency equipment - Electromagnetic disturbance characteristics - Limits and methods of measurement
- CISPR 14
Limits and methods of measurement of radio disturbance characteristics of electrical motor-operated and thermal appliances for household and similar purposes, electric tools and electric apparatus
- CISPR 22
Information technology equipment - Radio disturbance characteristics - Limits and methods of measurement
- EN 55011
Limits and methods of measurement of radio disturbance characteristics of industrial, scientific and medical (ISM) radio frequency equipment
- EN 55014
Limits and methods of measurement of radio disturbance characteristics of household appliances, electric tools and similar apparatus (conducted emission part)
- EN 55 022
Limits and methods of measurement of radio interference characteristics of information technology equipment

- IEC 61000-6-3
Electromagnetic compatibility (EMC)
Part 6: Generic standards
Section 3: Emission standard for residential, commercial and light-industrial environments
- IEC 61000-6-4
Electromagnetic compatibility (EMC)
Part 6: Generic standards
Section 4: Emission standard for industrial environments
- EN 50081-1
Electromagnetic compatibility (EMC)
Generic emission standard
Part 1 - Residential, commercial and light industry
- EN 50081-2
Electromagnetic compatibility (EMC)
Generic emission standard
Part 2 - Industrial environment.

Specific standards

- Centres de télécommunications
I 12-10, 1993
published by Comité des Spécifications des Equipements (CSE) France Télécom.
Environnement électromagnétique des équipements des centres.
(partie immunité aux perturbations rayonnées et partie perturbations rayonnées et conduites)
- MIL STD 461/462
Electromagnetic emission and susceptibility requirements for the control of electromagnetic interference

Non-standardized tests

Within the limits of available expertise and facilities, the laboratory can perform tests complying with other standards.

Appendix 4: Bibliography

Standards

- IEC 60364
Low voltage electrical installations
- IEC 61000-2
Electromagnetic compatibility (EMC)
Part 2: Environment
Section 1: Description of the environment -
Electromagnetic environment for conducted
disturbances
Section 2: Compatibility level for low-frequency
conducted disturbances and signalling in public
power supply systems
Part 4: Testing and measurement techniques
Part 6: Generic standards
- EN 55011
Industrial, scientific and medical (ISM) radio-
frequency equipment. Electromagnetic
disturbance characteristics. Limits and methods
of measurement
- EN 55022
Limits and methods of measurement of radio
interference characteristics of information
technology equipment

Schneider Electric Cahiers Techniques

- Electrical disturbances in LV
Cahier technique no. 141
R. CALVAS
- Behaviour of the SF6-MV circuit breakers
Fluarc for switching motor starting currents
Cahier technique no. 143
J. HENNEBERT and D. GIBBS
- Cohabitation of high and low currents
Cahier technique no. 187
R. CALVAS and J. DELABALLE

Other publications

- Compatibilité électromagnétique - bruits et
perturbations radioélectriques -
P. DEGAUQUE and J. HAMELIN
Dunod éditeur
- Compatibilité électromagnétique
M. IANOVICI and J.-J. MORF
Presses Polytechniques Romandes
- La compatibilité électromagnétique
A. KOUYOUMDJIAN, with R. CALVAS and
J. DELABALLE
Institut Schneider Formation
February 1996, ref. MD1CEM1F
- Les harmoniques et les installations
électriques
A. KOUYOUMDJIAN
Institut Schneider Formation
April 1998, ref. MD1HRM1F
- RGE no. 10 consacré à la compatibilité
électromagnétique
November 1986

Schneider Electric

Direction Scientifique et Technique,
Service Communication Technique
F-38050 Grenoble cedex 9
Télécopie : 33 (0)4 76 57 98 60
E-mail : fr-tech-com@mail.schneider.fr

DTP: Schneider Electric
Edition: Schneider Electric

- 20 € -