

Cahier technique no. 193

MV breaking techniques

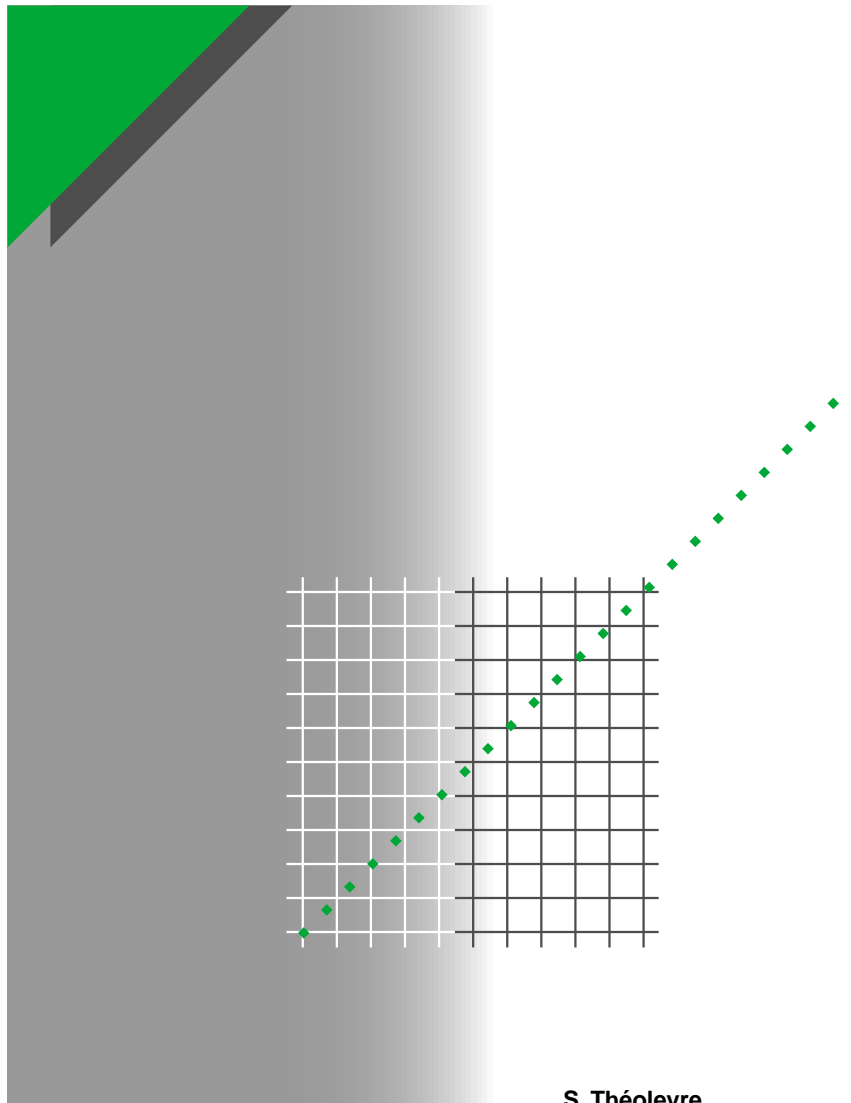

- Merlin Gerin
- Modicon
- Square D
- Telemecanique

S. Théoleyre

"Cahiers Techniques" is a collection of documents intended for engineers and technicians, people in the industry who are looking for more in-depth information in order to complement that given in product catalogues.

Furthermore, these "Cahiers Techniques" are often considered as helpful "tools" for training courses.

They provide knowledge on new technical and technological developments in the electrotechnical field and electronics. They also provide better understanding of various phenomena observed in electrical installations, systems and equipments.

Each "Cahier Technique" provides an in-depth study of a precise subject in the fields of electrical networks, protection devices, monitoring and control and industrial automation systems.

The latest publications can be downloaded from the Schneider Electric internet web site.

Code: <http://www.schneider-electric.com>

Section: **Experts' place**

Please contact your Schneider Electric representative if you want either a "Cahier Technique" or the list of available titles.

The "Cahiers Techniques" collection is part of the Schneider Electric's "Collection technique".

Foreword

The author disclaims all responsibility subsequent to incorrect use of information or diagrams reproduced in this document, and cannot be held responsible for any errors or oversights, or for the consequences of using information and diagrams contained in this document.

Reproduction of all or part of a "Cahier Technique" is authorised with the prior consent of the Scientific and Technical Division. The statement "Extracted from Schneider Electric "Cahier Technique" no." (please specify) is compulsory.

no. 193

MV breaking techniques

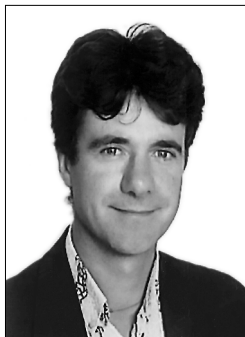

Serge THEOLEYRE

Dr. Theoleyre joined Schneider Electric in 1984 after having obtained a Doctorate in Engineering from the “Ecole Nationale Supérieure d’Ingénieurs Electriciens” in Grenoble in 1983. Initially he took charge of research and development and then marketing for the Power Capacitor activity.

Since 1995, he has been responsible for Schneider Electric’s actions in the fields of standardization and technical communication within the Transmission and Distribution Business sector (HV/MV).

Breaking Capacity:

A presumed current value that a switching device must be capable of breaking under the recommended conditions of use and behavior.

Earthing fault:

Fault due to the direct or indirect contact of a conductor with the earth or the reduction of its insulation resistance to earth below a specified value.

Fault:

Accidental modification affecting normal operation.

 I_r :

Rated current corresponding to the rms. value of the current that the device must be capable of withstanding indefinitely under the recommended conditions of use and operation.

Isc:

Short-circuit current.

Overvoltage:

Any voltage between a phase conductor and the earth or two neutral phase conductors where the peak value exceeds the highest voltage acceptable for the equipment.

Overvoltage factor:

Ratio between the overvoltages' peak value and the peak value of the maximum voltage acceptable by the device.

Rated value:

Value generally set by the manufacturer for given operating conditions for a component, a mechanism or piece of equipment.

Re-ignition:

Resumption of current between the contacts of a mechanical switching device during a breaking operation, **within** a quarter cycle after passing to 0 current.

Re-striking:

Resumption of current between the contacts of a mechanical switching device during a breaking operation, **after** a quarter cycle after passing to 0 current.

Short-circuit:

An accidental or intentional connection through a resistance or relatively low impedance, of two or more points on a circuit normally existing at different voltages.

Switching device:

Device intended to establish or interrupt current in an electrical circuit.

Switchgear:

General term applicable to switching devices and their use in combination with control, measurement, protection, and command devices with which they are associated.

Time constant for de-ionization:

Time at the end of which arc resistance will have doubled assuming that its rate of variation remains constant.

Transient recovery voltage:

Recovery voltage between the contacts of a switching device during the time where it presents a noticeable transient character.

 U_r :

Rated voltage corresponding to the rms. value of the voltage that the device must be capable of withstanding indefinitely under the recommended conditions of use and operation.

MV breaking techniques

The ability to break current in an electrical circuit is essential in order to guarantee the safety of people and property in the case of faults, as well as to control the distribution and use of electrical energy.

The aim of this Cahier Technique is to detail the advantages, disadvantages and applicational fields of past and present Medium Voltage breaking techniques.

Having defined the currents to be broken and discussed breaking on a theoretical level, the author goes on to present breaking in air, oil, and in SF₆, finishing with two comparative tables.

To date, breaking using electrical arcing remains the only viable solution, whether in SF₆ or under vacuum; it requires expertise that this Cahier Technique invites you to share.

Contents

1 Introduction		p. 4
2 Breaking load and fault currents	2.1 Breaking principle	p. 6
	2.2 Breaking load currents	p. 9
	2.3 Breaking fault currents	p. 13
3 Breaking techniques	3.1 Breaking medium	p. 17
	3.2 Breaking in air	p. 18
	3.3 Breaking in oil	p. 19
	3.4 Breaking under vacuum	p. 21
	3.5 Breaking in SF ₆	p. 24
	3.6 Comparison of the various techniques	p. 29
	3.7 What possibilities for other techniques?	p. 30
4 Conclusion		p. 31
Bibliography		p. 32

1 Introduction

Electrical energy is transmitted from the generating power station to consumer points via an electrical network (shown in **figure 1**). It is essential to be able to interrupt the current at any point in the network in order to operate or maintain the network or to protect it when a fault occurs. It is also necessary to be able to restore current in various normal or fault situations. In order to choose the devices intended to accomplish this task, information on the current to break and the field of application is crucial (see **fig. 2**). It can fall into one of three categories:

- Load current, which is normally smaller than the rated current I_r . The rated current, I_r , is the rms. value of current that the equipment must be capable of withstanding indefinitely under the recommended conditions of use and operation.
- Overload current, when the current exceeds its rated value.
- Short-circuit current, when there is a fault on the network. Its value depends on the generator, the type of fault and the impedances upstream of the circuit.

Furthermore, when opening, closing or in continuous service the device is subjected to several stresses:

- dielectrical (voltage),
- thermal (normal and fault currents),

- electrodynamic (fault current),
- mechanical.

The most important stresses are those which occur during transient operation and breaking, which are accompanied by electrical arcing phenomena. Arcing behavior is difficult to predict despite current modeling techniques.

Experience, know-how and experimentation still play a large part in designing breaking devices. They are called “electromechanical” devices, since at present static breaking in medium and high voltage is not technically and economically viable.

Of all of these breaking devices, circuit breakers are the most interesting since they are capable of making, withstanding, and breaking currents under normal and abnormal conditions (short-circuit). This Cahier Technique will mainly discuss breaking alternating current using circuit breakers.

The voltage range considered is that of Medium Voltage (1 kV - 52 kV), since it is in this voltage range that the greatest number of breaking techniques exist. The first part of the document will deal with phenomena occurring during breaking and closing. The second part presents the four most wide-spread types of breaking techniques currently used i.e. breaking in air, oil, vacuum and SF₆.

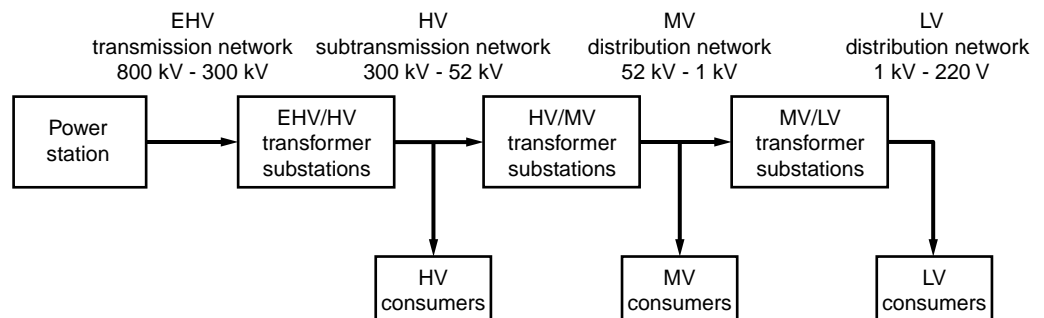

Fig. 1 : diagram of an electrical network.

	<ul style="list-style-type: none"> ■ IEC definition ■ Function 	Opening			Closing			Isolating
		○	●	⚡	○	●	⚡	
Disconnecter	<ul style="list-style-type: none"> ■ Mechanical connection device which in an open position guarantees satisfactory isolating distance under specific conditions. ■ Intended to guarantee safe isolation of a circuit, it is often associated with an earthing switch. 	yes	no	no	yes	no	yes □	yes
Earthing switch	<ul style="list-style-type: none"> ■ Specially designed switch for connecting phase conductors to the earth. ■ Intended for safety in case of work on the circuits, it relays the de-energized active conductors to the earth. 	yes	no	no	yes	no	yes □	no
Switch	<ul style="list-style-type: none"> ■ Mechanical connection device capable of establishing, sustaining and breaking currents under normal circuit conditions eventually including overload currents in service. ■ Intended to control circuits (opening and closing), it is often intended to perform the insulating function. In public and private MV distribution networks it is frequently associated with fuses. 	yes	yes	no	yes	yes	yes	yes □
Contactor	<ul style="list-style-type: none"> ■ Mechanical connection device with a single rest position, controlled other than by hand, capable of establishing, sustaining and breaking currents under normal circuit conditions, including overvoltage conditions in service. ■ Intended to function very frequently, it is mainly used for motor control. 	yes	yes	no	yes	yes	yes	no
Circuit breaker	<ul style="list-style-type: none"> ■ Mechanical connection device capable of establishing, sustaining and breaking currents under normal circuit conditions and under specific abnormal circuit conditions such as during a short-circuit. ■ General purpose connection device. Apart from controlling the circuits it guarantees their protection against electrical faults. It is replacing contactors in the control of large MV motors. 	yes	yes	yes	yes	yes	yes	no

○ = at no load ● = under load ⚡ = short-circuit □ = depending on the case

Fig. 2 : various switching devices, their functions and their applications

2 Breaking load and fault currents

2.1 Breaking principle

An ideal breaking device would be a device capable of breaking current instantaneously. However, no mechanical device is capable of breaking current without the help of electrical arcing. This phenomenon limits overvoltages and dissipates the electromagnetic energy of the electrical circuit, but it delays complete breaking of the current.

The ideal switch

Theoretically speaking, being able to break current instantaneously, it involves being able to pass directly from the state of conductor to the state of insulator. The resistance of the "ideal" switch must therefore pass immediately from zero to infinity, (see **fig. 3**).

This device must be capable of:

- absorbing the electromagnetic energy accumulated in the circuit before breaking, i.e.

$\frac{1}{2} Li^2$ in case of a short-circuit due to the reactive nature of the networks;

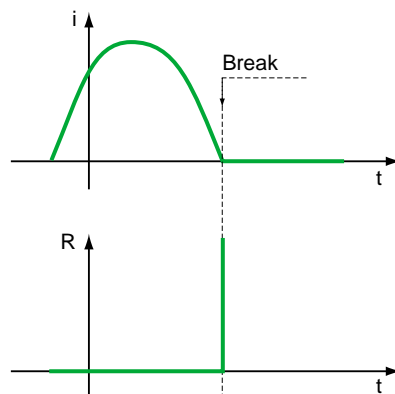
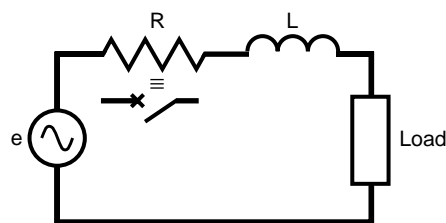

Fig. 3 : breaking by an ideal switch.

- withstanding the overvoltage (Ldi/dt) appearing across the terminals of the device and which would have an infinite value if passing from insulator to conductor occurred in an infinitely small period of time. This would inevitably lead to dielectric breakdown.

Assuming that these problems have been eliminated and that perfect synchronization has been achieved between the natural passing of the current to 0 and the device's insulator-conductor transition, there still remains another difficult aspect to take into consideration, that of transient recovery voltage (TRV).

In fact, just after the current has been interrupted, the recovery voltage across the switch's terminals joins the network voltage which is at its maximum at this moment for reactive circuits. This occurs without an abrupt discontinuity due to the parasite capacitances of the network. An unsteady state is set up whilst the voltage comes back in line with that of the network. This voltage, called transient recovery voltage (TRV), depends on network characteristics and the rate of increase (dv/dt) of this voltage can be considerable (several kV / microsecond). To put it simply this means that to avoid breaking failure, the ideal switch must be capable of withstanding several kV less than one microsecond after the transition from conductor-insulator.

Breaking using electrical arcing

Two reasons explain the existence of electrical arcing:

- It is practically impossible to separate the contacts exactly at the natural 0 current point due to the uncertainty in the measurement-order: for an rms. value of 10 kA, the instantaneous current 1 ms before 0 is still at 3,000 A. The instantaneous overvoltage Ldi/dt which would appear across the terminals of the device if it immediately became insulating would be infinite and lead to the immediate breakdown across the inter-contact gap which is still small.

- Separation of the contacts must be accomplished at sufficient speed for the dielectric strength between the contacts to remain greater than the transient recovery voltage. This requires mechanical energy close to infinity, that no device can provide in practice.

The electrical arcing breaking process takes place in three phases :

- the sustained arc phase,
- the arc extinction phase,
- the post-arcing phase.

■ Arc propagation phase

Before reaching zero current the two contacts separate causing dielectric breakdown of the inter-contact medium. The arc which appears is made up of a plasma column composed of ions and electrons from the inter-contact medium or metal vapor given off by the electrodes (see **fig. 4**). This column remains conductive as long as its temperature is maintained at a sufficiently high level. The arc is thereby "sustained" by the energy that it dissipates by the Joule effect.

The voltage which appears between the two contacts due to the arc's resistance and the surface voltage drops (cathodic and anodic voltage) is called the arcing voltage (U_a).

Its value, which depends on the nature of the arc, is influenced by the intensity of the current and by the heat exchange with the medium (walls, materials, etc.). This heat exchange which is radiative, convective and conductive is characteristic of the device's cooling capacity. The arc voltage's role is vital since the power dissipated in the device during breaking strongly depends on it.

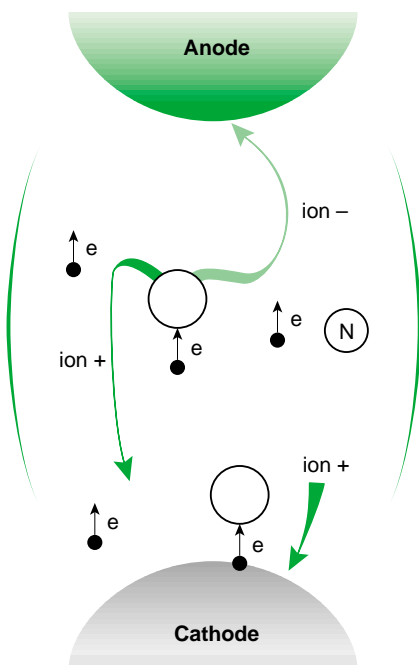

Fig. 4 : electrical arcing in a gaseous medium.

$$W = \int_{t_0}^{t_{arc}} U_a \, idt \quad \text{where } t_0 \text{ is the moment of arc}$$

initiation and t_{arc} is the moment of breaking. In medium voltage and high voltage, it always remains well below network voltages and does not therefore have a limiting effect, except in particular cases discussed further on. Breaking is therefore near the "natural" zero of the alternating current.

■ Arc extinction phase

Interrupting of the current corresponding to arc extinction is accomplished at zero current on condition that the medium quickly becomes insulating again. For this to occur, the channel of ionized molecules must be broken. The extinction process is accomplished in the following manner: near zero current, resistance to the arc increases according to a curve which mainly depends on the de-ionization time constant in the inter-contact medium (see **fig. 5**).

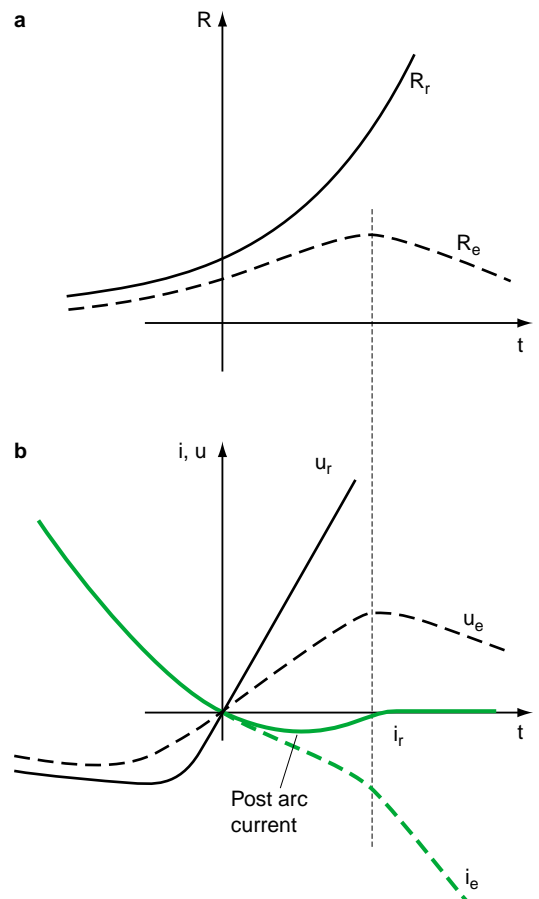

Fig. 5 : change in arc resistance [a] current and voltage [b] during the extinction phase in case of successful breaking (r) or thermal failure (e).

At zero current, this resistance has a value which is not infinite and a post-arcing current once again crosses the device due to the transient recovery voltage which appears across the terminals.

If the power dissipated by the Joule effect exceeds the characteristic cooling capacity of the device, the medium no longer cools down: thermal runaway followed by another dielectric breakdown takes place: resulting in thermal failure.

If on the other hand the increase in voltage does not exceed a certain critical value, the arc's resistance can increase sufficiently quickly so that the power dissipated into the medium remains less than the cooling capacity of the device thereby avoiding thermal runaway.

■ Post-arcing phase

In order for breaking to be successful, it is also necessary for the rate of dielectric recovery to be much quicker than that of the TRV (see fig. 6) otherwise dielectric breakdown occurs.

At the moment when dielectric failure occurs, the medium once again becomes conductive, generating transient phenomena which will be looked at in more detail further on.

These post-breaking dielectric failures are called:

- re-ignition if it takes place within the quarter of a period following the zero current,
- re-striking if it takes place afterwards.

■ TRV in the standards

Even though the rate of increase of TRV has a fundamental impact of on the breaking capacities of devices, this value cannot be precisely determined for all network configurations.

Standard IEC 60056 defines a TRV range for each rated voltage corresponding to the requirements normally encountered (see fig. 7).

The breaking capacity of a circuit breaker is therefore defined as: the highest current that it can break at its rated voltage with the corresponding rated TRV.

A circuit breaker must be capable of breaking all currents less than its breaking capacity for all TRVs whose value is less than the rated TRV value.

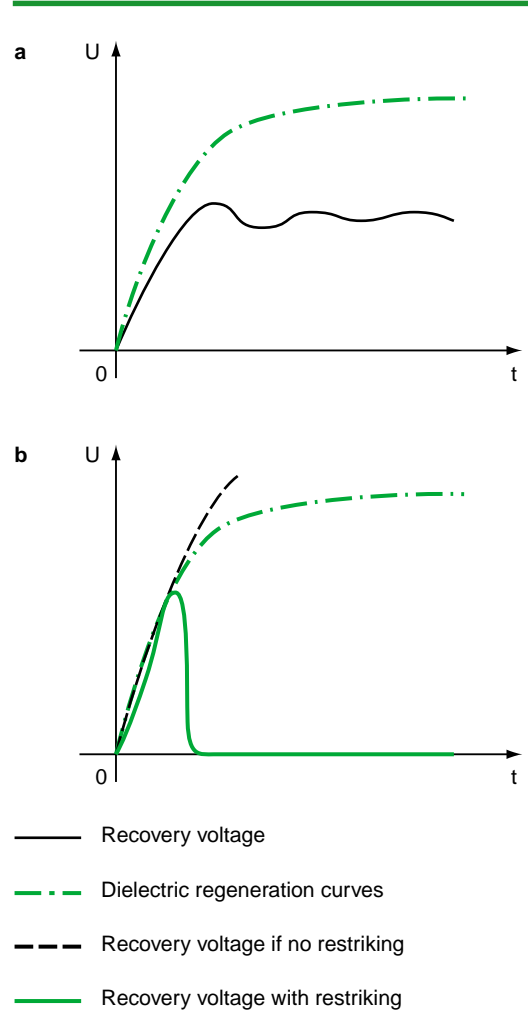

Fig. 6 : dielectric recovery curves: successful breaking [a] or dielectric failure [b].

Rated voltage (U _r in kV)	7.2	12	17.5	24	36	52
Peak TRV value (U _C in kV)	12.3	20.6	30	41	62	89
Time t ₃ (in μs)	52	60	72	88	108	132
Rate of increase (U _C / t ₃)	0.24	0.34	0.42	0.47	0.57	0.68

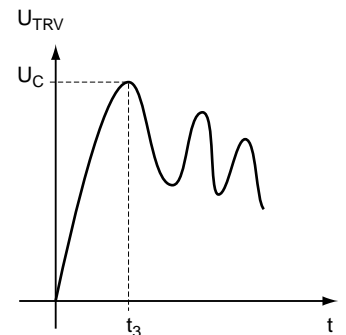

Fig. 7 : rated transient recovery voltage in the case of a short-circuit across the terminals of a circuit breaker (§ 4.102 IEC standard 60056).

2.2 Breaking load currents

Under normal operation, in MV, circuit breaking occurs:

- with a load current from a few to a few hundred amperes, a low value relative to the short-circuit current (from 10 to 50 kA);
- with a power factor greater than or equal to 0.8. The phase shift between the electrical circuit voltage and the current is small and the minimum voltage occurs around the current's minimum (highly resistant circuit).

The voltage across the terminals of the breaking device is established while network voltage is practically without any transient phenomena (see **fig. 8**).

Under such conditions, breaking generally occurs without any problems since the device is dimensioned for high currents in quadrature with the voltage.

Breaking inductive currents

■ Current chopping

Breaking inductive currents can give rise to overvoltages caused by early breaking of the current, otherwise known as "current chopping" phenomena.

For low inductive currents (from a few amperes to a several dozens of amperes), the cooling capacity of the devices dimensioned for the short-circuit current is much higher in relation to the energy dissipated in the arc. This leads to

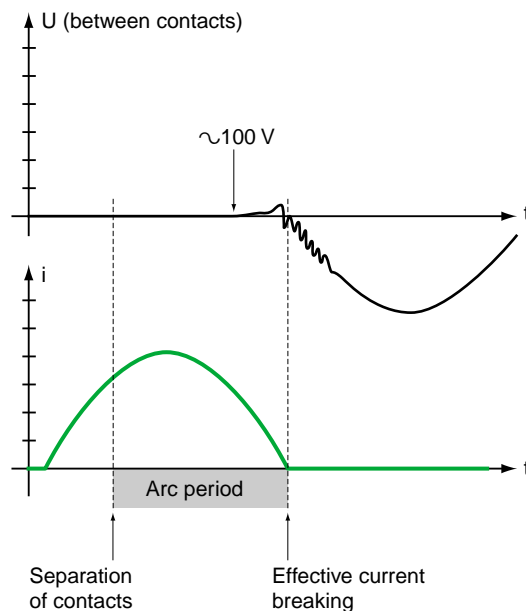
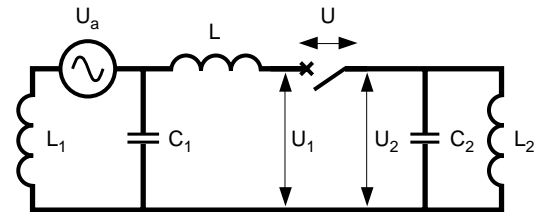

Fig. 8 : there are very few transient phenomena during the breaking of a resistive load current.

arc instability and an oscillating phenomena occurs which is "seen" by the breaking device and the inductances (see **fig. 9** and **fig. 10**). During this high frequency oscillation (of around 1 MHz) passing to zero current is possible and the circuit breaker can interrupt the current before it passes to its natural zero at the industrial frequency (50 Hz).



L_1, C_1 = upstream inductance and capacity (supply source),
 L_2, C_2 = downstream inductance and capacity (transformer primary),
 L = connection inductance downstream of circuit breaker D (busbars or cables).

Fig. 9 : diagram of the circuit on breaking a low inductive current.

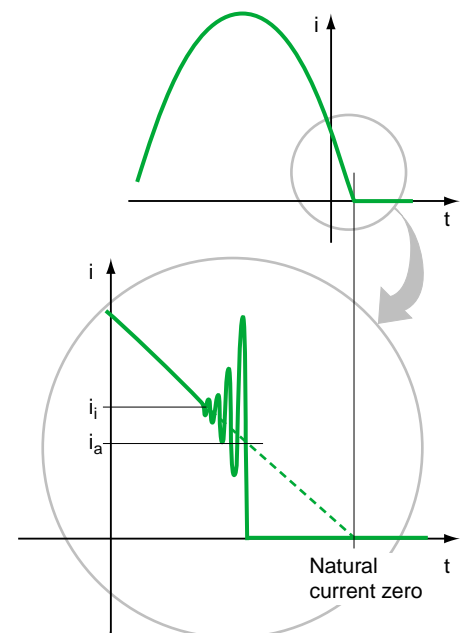

i = current in the circuit breaker,
 i_i = current value leading to instability,
 i_a = chopped current value.

Fig. 10 : high frequency oscillating phenomena or "current chopping" on breaking an inductive current.

This phenomenon, called “current chopping”, is accompanied by a transient overvoltage mainly due to the oscillatory state which is set up on the load side (see **fig. 11**).

The maximum value of the overvoltage (U_{Cmax}) on the load side is given by the following equation:

$$U_{Cmax}^2 = u_a^2 + \left[\frac{\eta_m L_2 i_a^2}{C_2} \right]$$

in which:

u_a = chopping voltage,
 i_a = chopping current,
 η_m = magnetic efficiency.

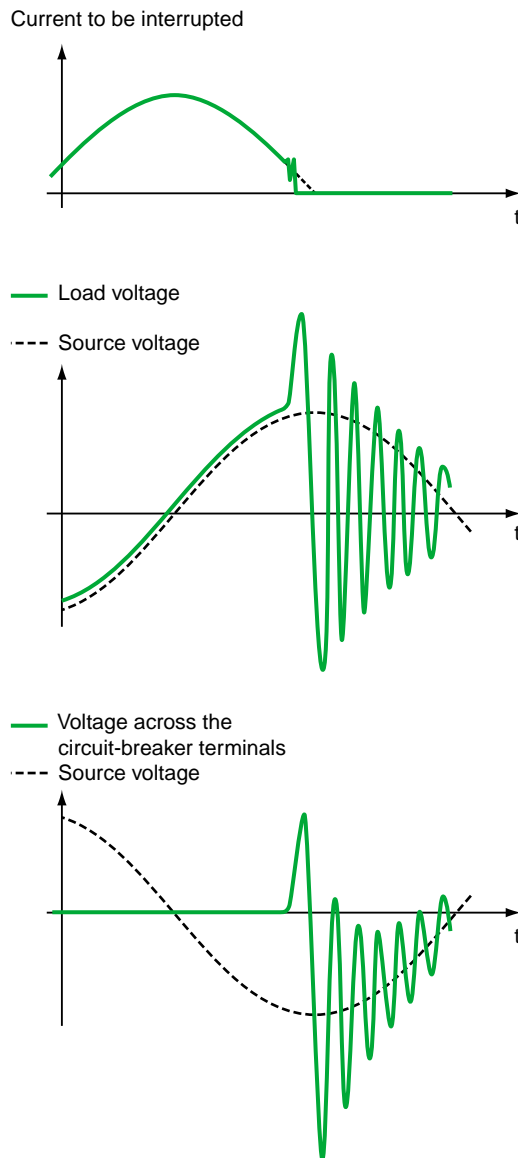

Fig. 11 : voltage and current curves at the time of breaking low inductive currents.

On the supply side, the voltage value is equal to the value of the chopping voltage tending towards the network voltage, U_n with an oscillating state depending on C_1 and L_1 . The voltage value between the contacts of the circuit breaker is equal to the difference between these two voltages.

These equations clearly show the influence of the network’s characteristics, bearing in mind that the chopping current depends strongly on C_1 and on the concerned device.

■ Re-ignition

Another phenomena can lead to high overvoltages. It is re-ignition during opening. Generally speaking, re-ignition is inevitable for short arcing periods since the distance between contacts is not sufficient to withstand the voltage which appears across the terminals of the device. This is the case each time an arc appears just before the current passes to natural zero. The voltage on the load side rejoins the voltage on the supply side with an unsteady state oscillating at high frequency (around 1 MHz). The peak value of the oscillation, determined by the load voltage of the downstream parasite capacitances is therefore twice the preceding value.

If the circuit breaker is capable of breaking high frequency currents, it will manage to break the current the first time it passes to zero a few microseconds after re-ignition. Re-ignition is very likely to reoccur due to the increase in the amplitude of oscillation and the phenomena is repeated causing an escalation in voltage which can be dangerous for the load (see Cahier Technique no. 143).

It should be noted that the same phenomena appears during device closure: it causes pre-striking when the contacts are brought sufficiently close together. As in cases of successive re-ignition, the stored energy increases at each breaking attempt but the voltage increase is limited by the bringing together of the contacts.

■ Field of application

In Medium Voltage this involves the magnetizing currents of transformers under no load or low load, motors and shunt inductances.

□ Transformers under no load or low load

Transformers can be operated under low load conditions (e.g. at night) for network management requirements. The currents corresponding to their magnetizing currents vary from a few amperes to several dozens of amperes and their chopping factor can be very high. However, even if the current is chopped at its peak value, the possible overvoltage factors are generally low taking into account the capacitances and the inductances involved.

In overhead distribution, the risk related to the appearance of overvoltage current is even lower since it is limited by lightning arrestors. Furthermore, standards relating to transformers define impulse wave tests which confirm their capacity to withstand operational overvoltages.

□ Shunt inductances

These inductances are used to compensate for the reactive component of the lines or to avoid increases in voltage on very long lines with low loads. They are most often used in HV but can also be used in MV.

Breaking overvoltages generally remain below an overvoltage factor of 2.5 due to the impedances involved. If there is a risk that the breaking overvoltage will exceed this limit, lightning arrestors and breaking resistors are connected in parallel with the circuit breaker.

□ Motors

Stator and rotor windings of motors are so that the current absorbed under no load conditions by these motors as well as the start-up currents are basically inductive. Given the great number of switching operations, overvoltages occur very often and can become critical because of the progressive deterioration in the insulation that they engender, in particular if opening occurs during the start-up phases.

As a general rule, circuit breakers must be chosen that do not re-strike or that have a low probability of re-striking. Otherwise, R-C systems can also be placed across the motor's terminals in order to deviate high frequency transient currents or ZnO type voltage limiting systems.

■ Breaking inductive currents and the standards.

International standards do not exist regarding the breaking of inductive currents, however IEC technical report 61233 stipulates tests for circuit breakers used to supply the motors and shunt inductances.

□ Motors

For circuit breakers with rated voltages between 1 kV and 17.5 kV, a standardized circuit simulating a blocked motor is specified for laboratory tests.

□ Shunt inductances

They are not very wide-spread in MV, nevertheless, they are sometimes used in 36 kV. The tests carried out in a laboratory are solely defined for three phase circuits with a rated voltage greater than 12 kV.

Breaking capacitive currents

Breaking capacitive currents can cause to overvoltages due to re-striking during the voltage recovery phase.

■ In theory, capacitive currents can be broken without any difficulty. In fact, when the device

interrupts the current, the voltage across the terminals of the generator is at its maximum since the current and the voltage are out of phase by $\pi/2$; since the capacitor remains charged at this value after current breaking, the voltage across the terminals of the switch, initially at 0, slowly increases without TRV and with a derivative in relation to time (dv/dt) equal to zero at the origin.

■ On the other hand re-striking problems are difficult. In fact, after a $1/2$ -period, the network voltage is reversed and the voltage across the terminals of the switch reaches twice the peak value. The risk of re-striking between the contacts is therefore increased and this is proportional to the slowness of opening. If there is re-striking at peak voltage, the capacitor is discharged in the circuit's inductance creating an oscillating current with a peak voltage of 3 (see fig. 12). If breaking is effective at the following zero current, the capacitor remains charged at a voltage of 3.

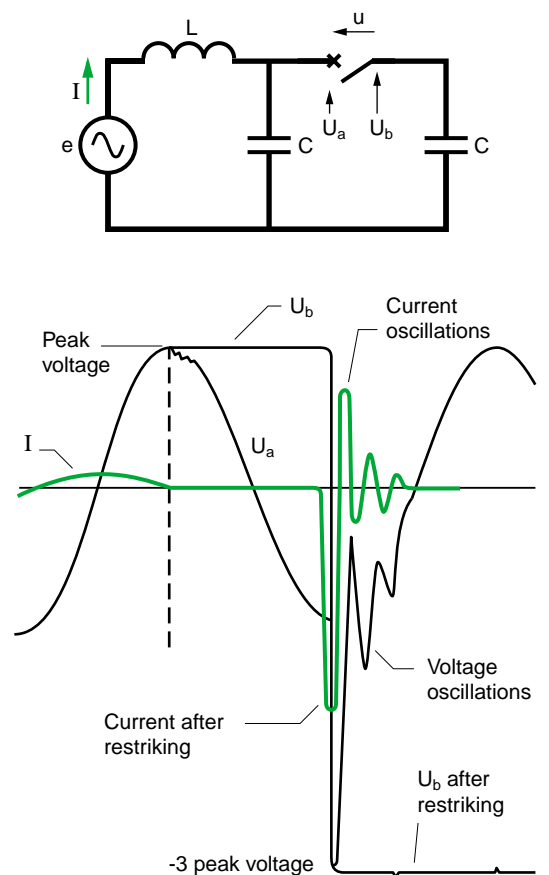

Fig. 12 : diagram of a circuit with a capacitive load: during breaking if the circuit breaker does not open quickly enough, successive re-striking can cause dangerous overvoltages for the load.

When voltage “e” is once again reversed, the peak voltage across the terminals of the switch becomes equal to 5. The overvoltage can therefore lead to re-striking again. The phenomena can continue with a voltage across the terminals of the switch capable of reaching values of 7, 9, etc.

For all re-striking occurring 1/4 of the period following zero current, an “escalation of voltage” can be observed which can lead to unacceptable peak values for loads.

On the other hand re-striking, which occurs depending on the breaking device’s dimensions, is tolerable: the oscillating voltage across the terminals of the capacitor remains at an absolute value less than the peak value of the generator’s voltage, which does not represent any particular danger for the devices.

As a reminder, capacitor overvoltage testing is performed at 2.25 times the rated voltage value. Dielectric recovery of the inter-contact medium must therefore be sufficiently quick for no re-striking to occur after the quarter period.

■ Making capacitive currents and pre-striking

When closing the control device supplying capacitive loads, phenomena specific to capacitive circuits are produced.

Thus, energizing a capacitor bank causes a high overcurrent at high frequency (see **fig. 13**) for which the peak magnitude is given by the equation:

$$I_p = \frac{U\sqrt{2}}{\sqrt{3}} \sqrt{\frac{C}{L_0 + L}}$$

where

L_0 = upstream network inductance

L = capacitor bank link inductances, generally low in relation to L_0 .

In the case of multi-stage banks, the phenomena is even more accentuated by the presence of the energy stored in the already energized capacitors: the transient currents can reach several hundreds of times the rated current with frequencies of several kHz due to the low values of link inductance between stages of the banks.

During pre-striking at the breaking device contacts (ignition of a conductive arc before the contacts join) these high transient currents cause early erosion of the breaking device contacts and eventually weld them. Limiting inductances (impulse impedances) are series connected with the bank in order to limit these phenomena.

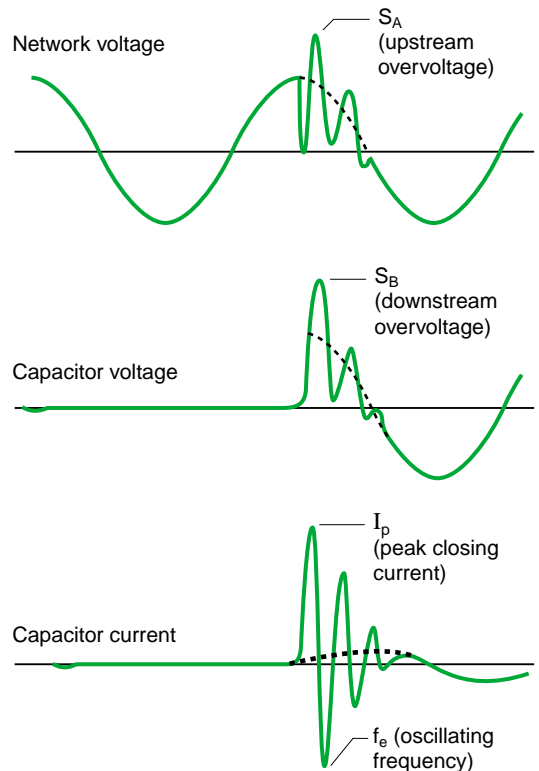
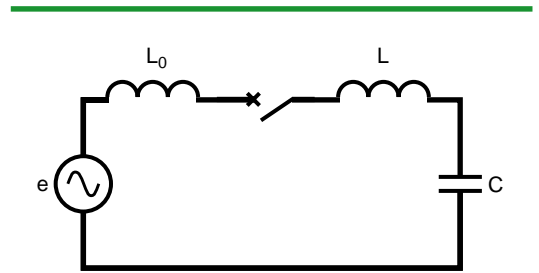

Fig. 13 : shapes of voltage and current (pre-strike overvoltage) during the coupling of a single stage capacitor to the network.

The aforementioned equation becomes:

$$I_p = \frac{U\sqrt{2}}{\sqrt{3}} \sqrt{\frac{C}{L}} \frac{n}{n+1}$$

where

n = number of capacitor bank stages with a value of C .

L = limiting inductances (impulse impedances), higher in relation to L_0 .

Note that devices adapted to this application exist and must be specified.

■ Fields of application

Capacitive currents mainly have two origins: cables and lines, and capacitor banks.

□ Cables and lines

This involves load currents in no-load cables and long overhead lines (compensated or not). In a number of European countries (especially countries in Southern Europe, France, Italy, Spain, etc.), MV overhead networks are long and therefore particularly sensitive to atmospheric overvoltages meaning a high amount of tripping occurs on these lines... therefore a lot of re-striking.

□ Capacitor banks

Capacitor banks are series connected to the networks and are used to compensate for the lines' reactive energy (transmission network) and loads (MV/LV). They enable the transmitted active power to be increased and line losses to be reduced. They can be:

- used alone in the case of low compensation and a stable load,
- staggered (multiple or divided). This type of bank is widely used by major industries (high installed power) and by utilities companies. It is associated with an automatic control and the number of operations can be high (several operations per day): devices capable of withstanding a suitable number of operations should be specified.

■ Breaking capacitive currents and the standards

The current IEC standard 60056 (4th edition, 1987) gives values, for all voltages, of the rated breaking capacity of circuit breakers used to

protect cables which may have no load. Its application is not mandatory and it is considered inappropriate for voltages less than 24 kV.

Regarding the rated breaking capacity of lines under no load, the specification is limited to devices with a rated voltage of 72 kV.

No value has been specified for capacitor banks.

IEC 60056 also specifies switching tests (see **fig. 14**) for protection and control devices under capacitive current conditions for lines and cables under no load and for single stage capacitor banks but does not specify anything for long lines nor for banks of filters.

Standards for capacitive current applications are tending to develop towards the definition of devices with a low probability of re-striking together with a broader specification of values and a higher number of switching operations in order to guarantee their suitability to the application.

Testing duty	Isc of the supply circuit as a function of circuit breaker's breaking capacity (Isc / Breaking capacity) x100	Testing current (% of rated I _{capa})
1	< 10	20 to 40
2	< 10	> 100
3	100	20 to 40
4	100	>100

Fig. 14 : testing specified by IEC 60056 for capacitive currents.

2.3 Breaking fault currents

In the case of a short circuit, the phase shift between the current and the voltage is always very large ($0.07 \leq \cos\phi \leq 0.15$), since networks are basically inductive. When the current passes to 0, network voltage is at, or almost at, its maximum.

In MV, short-circuit current reaches values of a few tens of thousands of amperes. Consequently, breaking takes place without current chopping since the arc is very stable. As for load currents, arcing can be broken down into three phases:

- a sustained arc phase till passing through zero current,

- an extinction phase,
- a recovery phase.

Short-circuit currents

■ The various fault types (see Cahier Technique no. 158)

Among the various types of faults (three-phase, two phase, single phase and earthing), the most frequent fault is the single phase earthing fault (80% of short-circuits). It is generally caused by phase-earth insulation faults following over-voltages of atmospheric origin, due to broken or faulty insulation or due to civil engineering works.

Three-phase short-circuits are rare (5% of the cases) but serve as a test reference since the short-circuit current and the TRV are higher than in single phase or two phase faults. Calculation of the fault current requires information on the network's characteristics and the neutral arrangement (insulated, directly earthed or impedant neutral). Methods of calculating have been developed and standardized (IEC 60909). Currently, calculation through computer simulation is fairly wide-spread, and all Schneider departments have developed software which they have at their disposal enabling them to obtain very reliable results.

■ Fault location

□ Faults on the circuit breaker's downstream terminals

It is under these conditions that short-circuit current is greatest since it is only limited by the impedances situated upstream of the device. Even though this type of fault is quite rare, it is the one that is chosen for MV circuit breaker specifications.

□ Line faults

This type of fault is more common than the previous type in overhead networks, but in MV, circuit breaker arcing characteristics and circuit breaker/ cable / line connections mean that the stresses generated are less than those caused by a short-circuit across the terminals. There are therefore no specific tests for MV circuit breakers. In HV, this type of short-circuit requires specific tests for near-by faults since wave reflection phenomena cause extremely damaging TRVs.

□ Phase opposition type coupling (see fig. 15)

This is a special short-circuit scenario occurring when two unsynchronized generators are coupled.

When the two generators are out of synchronization, the voltage across the terminals of the coupling circuit breaker is equal to the sum of the voltages of each generator. The current which the circuit breaker must break can reach half the value of the current corresponding to a short-circuit at the point of coupling. The maximum is then attained during phase opposition type coupling.

IEC standard 60056 (§4.106) in this case requires that the device must be capable of breaking 25% of the fault current across the terminals at a voltage of 2.5 times the voltage to earth, covering the values encountered in practice.

■ Shape of the short-circuit current plot

The intensity of the current corresponding to the transient period during a short-circuit is the sum of two components, one symmetric or periodical (i_a) and the other asymmetric or continuous (i_c) (see fig. 16).

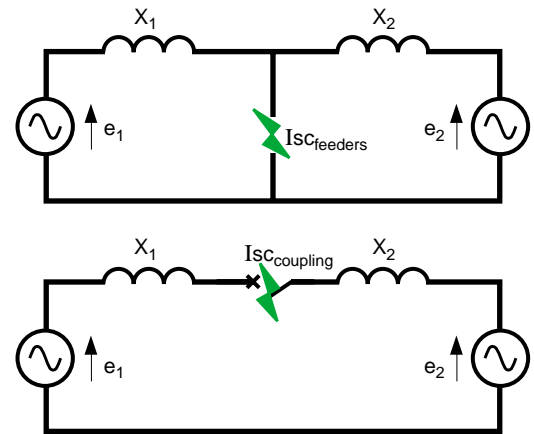

with $e_1 = e_2 = e$ and $X_1 = X_2 = X$

$$I_{sc_feeder} = \frac{e}{X} + \frac{e}{X} = \frac{2e}{X}$$

$$I_{sc_coupling} = \frac{2e}{2X} = \frac{e}{X}$$

Fig. 15 : breaking under out-of-phase conditions during the coupling of two generators which are out of synchronization.

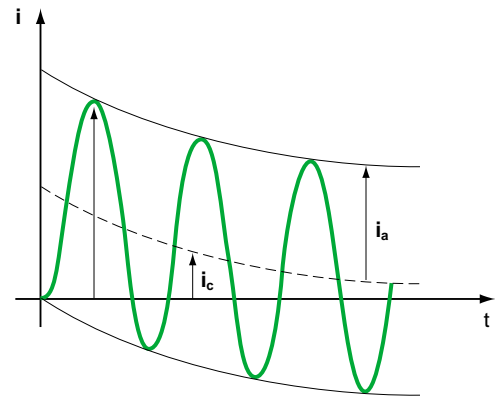

Fig. 16 : during a short-circuit the current is the sum of the two components, one symmetric or periodical (i_a) and the other asymmetric or continuous (i_c).

The symmetric component (i_a) is created by the alternating source which supplies the short-circuit current.

The continuous component (i_c) is created by the electromagnetic energy stored in the inductance at the time of the short-circuit. Its value at the moment of the fault is opposite and equal to that of the symmetric component to ensure the continuity of current. It decreases with a time constant L/R , characteristic of the network, for which the standardized value is 45 ms, resulting in the following equation:

$$i_a = I \sin(\omega t + \theta)$$

$$i_c = -I \sin\theta e^{-t/(L/R)}$$

$$I = \text{maximum intensity} = E/Z_{cc}$$

θ = electrical angle which characterizes the time between the initial moment of the fault and the beginning of the current wave.

Two extreme cases:

□ The short-circuit occurs at the moment at which voltage (e) passes to 0. The symmetric component and the continuous component are at their maximum value. This state is called fully asymmetrical.

□ The initial moment of the short-circuit coincides with the 0 point of the current's alternating component: the continuous component is zero and this state is called symmetrical.

Breaking capacity

Short-circuit breaking capacity is defined as the highest current that a device can break under its rated voltage in a circuit in which the TRV meets a specific specification.

The device must be capable of breaking all short-circuit currents with a periodic component less than its breaking capacity and a certain percentage of the aperiodic components that do not exceed the defined value.

According to the type of device, some fault currents less than the breaking capacity can prove difficult to break. They cause long arcing times with risks of non-breaking.

Three phase breaking

Due to the phase shift of three phase currents, breaking occurs in the following manner:

□ The circuit breaker breaks the current in the first phase (phase 1 in **figure 17**) in which the current passes to zero.

The arrangement becomes two-phased and everything occurs as if point N is shifted to N'. The voltage established in the first phase, across the terminals of the open AA' contact, is that already existing between A and N', it therefore equals:

$$U_{AA'} = kV = kU_r / \sqrt{3}$$

k is the factor of the first pole. Its value varies from 1 to 1.5 depending on whether the neutral is directly earthed or perfectly insulated.

□ 1/2 a period later each of the other two phases pass to zero, the circuit breaker breaks and the network becomes stable again in relation to the neutral point.

The TRV therefore depends on the neutral arrangement. The standard specifies the chosen values for the tests taking a value of 1.5 for MV in insulated neutral type networks and a value of 1.3 for other cases.

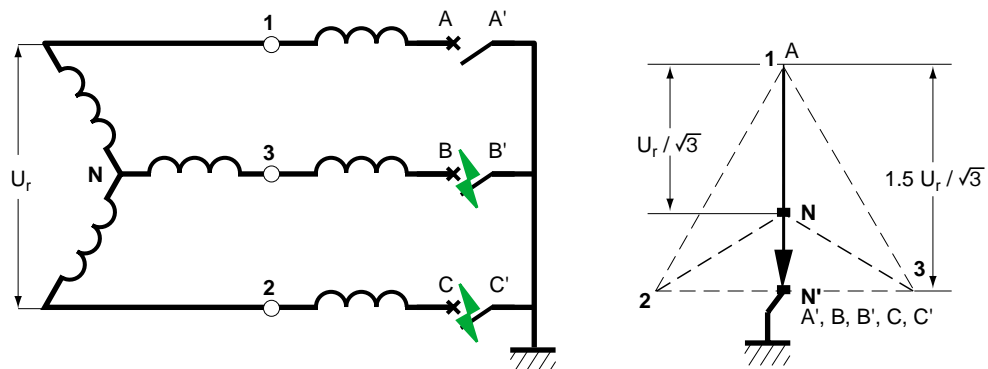

Fig. 17 : voltage $U_{AA'}$ withstood by the first pole which opens in a three phase device.

■ Closing of a circuit breaker under a fault current

Since faults are often spurious, it is common practice under normal operation to reclose the circuit breaker after interrupting a fault current. However some faults are permanent and the circuit breaker must be able to restore the short-circuit current.

Closure accompanied by pre-striking causes a high gradient voltage wave in which the current's peak can reach 2.5 I_{sc} , supposing complete asymmetry, a time constant of 45 ms at 50 Hz and no phase shift between the poles. A closing capacity is therefore required for circuit breakers.

■ Standardized breaking capacity

Circuit breaker compliance with standards notably shows their ability to break all currents up to the rated breaking current, including the so-called critical currents.

IEC Standard 60056 (4.104) requires a series of tests enabling the validation of the device's breaking capacity and the verification of its capability in terms of repeated opening and closing switching operations.

The rated breaking capacity is characterized by two values.

□ The rms. value of the periodic component, generally called breaking capacity

The standardized values of the rated breaking capacity are taken from the Renard series (6.3, 8, 10, 12.5, 16, 20, 25, 31.5, 40, 50, 63, 80, 100 kA), knowing that in practice short-circuit currents have values between 12.5 kA and 50 kA in MV.

□ The asymmetric component percentage

This corresponds to the value attained at the end of a period τ equal to the minimal duration of circuit breaker opening, to which is added a half-period of the rated frequency for devices with auxiliary sources. The time constant for

standardized exponential decay is 45 ms. Other greater values are currently under research in certain particular cases.

Short-circuit breaking tests are carried out at defined TRV values, for current values of 10, 30, 60 and 100% breaking capacity according to the table in **figure 18**.

The rated switching operation sequence is defined as follows, apart from in special circumstances:

□ for devices without quick automatic reclosing:

O - 3 mn - CO - 3 mn - CO

or

CO - 15 s - CO,

□ for devices intended for quick automatic reclosing:

O - 0.3 s - CO - 3 mn - CO.

with:

O = opening operation,

CO = closing operation immediately followed by an opening operation.

Testing duty	% de I_a (symmetric component)	% de I_c (asymmetric component)
1	10	< 20
2	30	< 20
3	60	< 20
4	100	< 20
5*	100	according to the standardized decay curve

*: for circuit breakers with a time τ less than 80 ms.

Fig. 18 : defined values of TRV for short circuit breaking testing of circuit breakers.

3 Breaking techniques

In order to break load or fault currents, manufacturers have developed and perfected breaking devices, and in particular circuit breakers and contactors, using various breaking

mediums: air, oil, vacuum and SF₆. While breaking in air or oil is tending to disappear, the same cannot be said for breaking under vacuum or in SF₆, the "champion" of medium voltage.

3.1 Breaking medium

The preceding chapter described how successful breaking occurs when:

- the power dissipated in arcing through the Joule effect remains less than cooling capacity of the device,
- the de-ionization rate of the medium is high,
- and the inter-contact space has sufficient dielectric strength.

The choice of breaking medium is therefore an important consideration in designing a device. In fact this medium must:

- have high thermal conductivity, and especially in the extinction phase to remove the arc's thermal energy,
- recover its dielectric properties as soon as possible in order to avoid spurious re-striking (figure 19 shows the special properties of SF₆ in this regard),
- at high temperatures, it must be a good electrical conductor to reduce arc resistance thus the energy to be dissipated,
- at low temperatures, it must be a good electrical insulator to make it easier to restore the voltage.

This insulating quality is measured by the dielectric strength between the contacts which depends on the gas pressure and the distance between the electrodes. The Paschen curve (see fig. 20 and 21), which gives the breakdown voltage as a function of the inter-electrode distance and the pressure, enables three zones to be determined according to gas pressure.

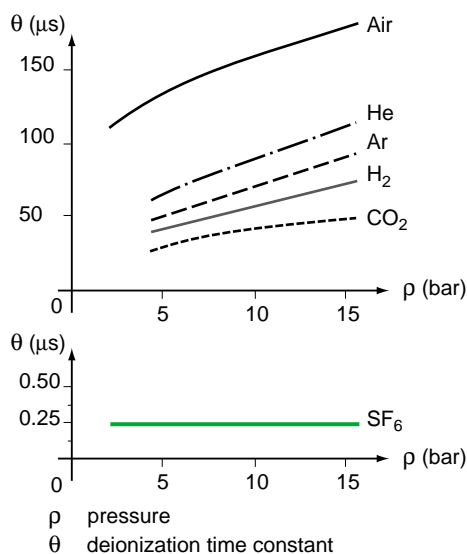

Fig. 19 : deionization time constants as a function of the pressure of various gases.

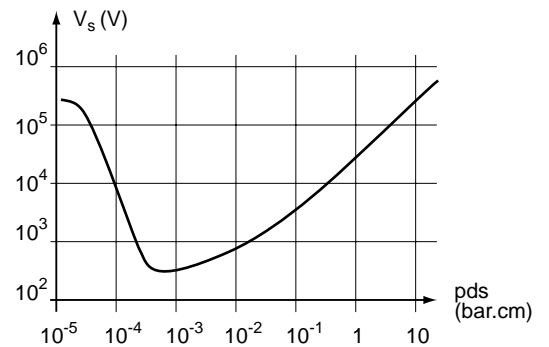

Fig. 20 : change in the dielectric strength of air as a function of the pressure, in a slightly heterogeneous field (Paschen curves).

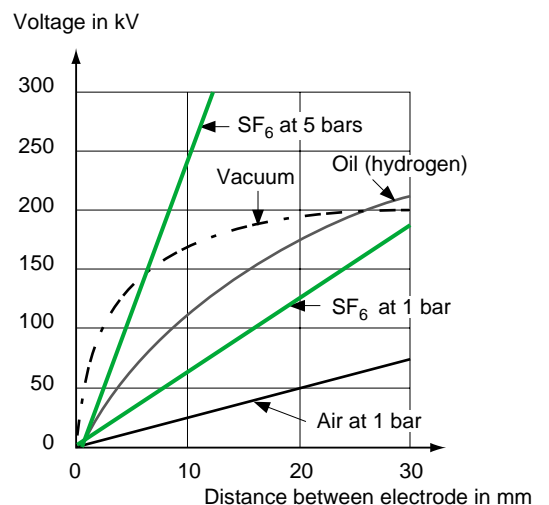

Fig. 21 : influence of inter-electrode gap on dielectric strength.

1- The high pressure zone called the "atmospheric state" in which the dielectric strength is proportional to the gas pressure and the inter-contact distance.

2- The low pressure zone in which dielectric strength reaches a true minimum between 200 and 600 V depending on the gas used (Paschen minimum). It is reached at a determined value of the product of the pressure and the inter-contact distance at around 10^2 mbar.cm.

3- The vacuum zone in which breakdown voltage only depends on the inter-contact gap and contact surface condition. Conductivity is provided by the electrons and the atoms pulled off of the contacts under vacuum and in a gas by the quick ionization of the gas' molecules.

These curves highlight the performances that are possible as a function of the breaking medium: air at atmospheric pressure or high pressure, hydrogen produced by the decomposition of oil, vacuum or SF₆. **Figure 22** shows the voltage ranges in which each of these techniques is currently used.

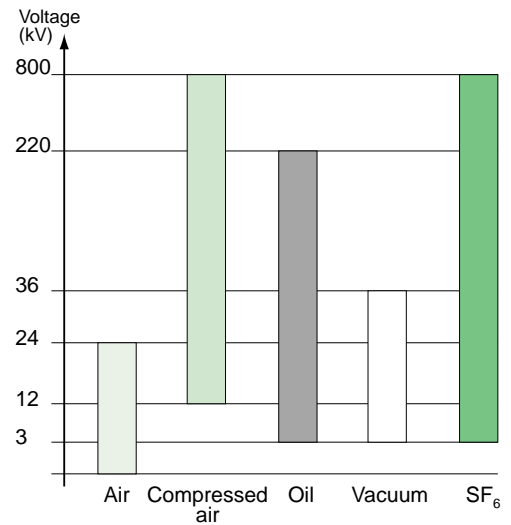

Fig. 22 : types of breaking devices used according to voltage values.

3.2 Breaking in air

Devices breaking in air at atmospheric pressure were the first to be used (magnetic circuit breakers).

Despite its relatively weak dielectric strength and its high de-ionization time constant (10 ms), air at atmospheric pressure can be used to break voltages up to around 20 kV.

For this it is necessary to have sufficient cooling capacity and a high arcing voltage after the current passes to zero in order to avoid thermal runaway.

The air breaking mechanism

The principle involves maintaining a short arc as long as the intensity is high in order to limit the dissipated energy, then lengthening it just as the current nears zero.

This principle has led to the creation of a breaking chamber for each pole of the device. The breaking chamber, situated around the inter-contact space is made up of a volume divided by refractory panels (panels with a high specific heat capacity) (see **fig. 23**) which the arc stretches between.

In practice, when the current decreases, the arc, which is subjected to electromagnetic forces, penetrates between these panels. It lengthens and cools on contact with the refractory material

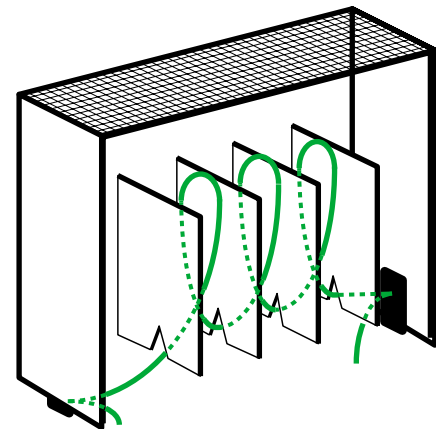

Fig. 23 : lengthening of an electrical arc between ceramic refractory panels in a breaking chamber of an air breaking circuit breaker (Solénarc type Circuit Breaker - Merlin Gerin Brand).

until its arcing voltage becomes greater than that of the network. The arcing resistance therefore greatly increases. The energy which is provided by the network then remains less than the cooling capacity and breaking takes place.

Due to the high deionization time constant for this technology, the arcing energy to be dissipated remains high. However, the risk of overvoltage at breaking is virtually non-existent (see [fig. 24](#)).

Main characteristics of an air breaking device

The dimensions of the breaking chamber are mainly defined by the network short-circuit power (in MVA).

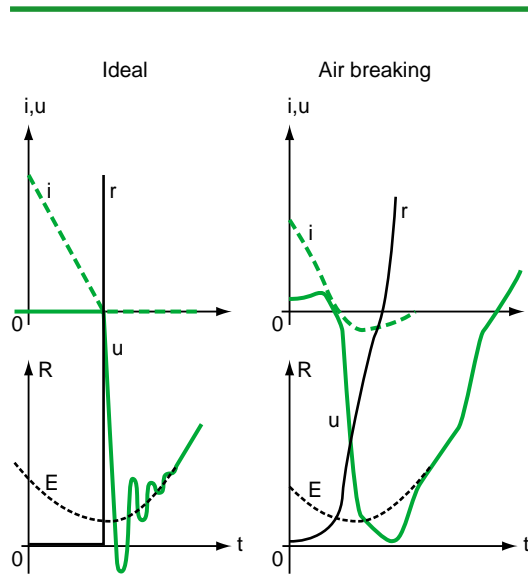

Fig. 24 : behavior comparison between an ideal device and an air breaking device.

In Solenarc type devices, the extreme length of the arc (several meters at 24 kV) is achieved in a reasonable volume thanks to the development of the arc in the form of a solenoid. Taking into account the required rate of opening of the contacts, (i.e. a few m/s), the operating energy is of the order of a few hundreds of Joules.

Fields of application for breaking in air

This type of device was commonly used in all applications but it remains limited to use with voltages of less than 24 kV. For higher voltages, compressed air is used to improve dielectric strength, cooling and deionization rate. The arc is therefore cooled by high pressure puffer systems (between 20 and 40 bars). This technique has been used for high performance circuit breakers or for higher voltages (up to 800 kV).

The air breaking technique at atmospheric pressure is universally used in LV due to its simplicity, its endurance, its absence of overvoltage and the limiting effect obtained by the lengthening of the relatively high voltage arc.

In MV other techniques have taken its place since breaking in air has several disadvantages:

- size of device (greater dimensions due to length of arc),
- breaking capacity influenced by the presence of metal partitions of the cubicle containing the device and air humidity,
- cost and noise.

MV circuit breakers using air breaking are practically no longer manufactured today.

3.3 Breaking in oil

Oil, which was already used as an insulator, has been used since the beginning of the century as a breaking medium because it enables relatively simple and economic devices to be designed. Oil circuit breakers are mainly used for voltages from 5 to 150 kV.

The principle

The hydrogen obtained by the cracking of the oil molecules serves as the extinction medium. It is a good extinguishing agent due to its thermal properties and its deionization time constant which is better than air, especially at high pressures.

The contacts are immersed in a dielectric oil. On separation, the arc causes the oil to break down releasing hydrogen ($\approx 70\%$), ethylene ($\approx 20\%$)

methane ($\approx 10\%$) and free carbon. An arcing energy of 100 kJ produces approximately 10 liters of gas. This gas forms a bubble which, because of the inertia of the oil's mass, is subjected during breaking to a dynamic pressure which can reach 50 to 100 bars. When the current passes to 0, the gas expands and blows on the arc which is extinguished.

The various types of oil breaking technologies

■ High volume oil circuit breakers

In the first devices using oil, the arc developed freely between the contacts creating unconfined gas bubbles. In order to avoid re-striking between phases or the terminals and earth, these bubbles must not in any case reach the

tank or join together (see **fig. 25**). These devices can consequently be extremely large. In addition to their cumbersome size, these devices have numerous disadvantages such as the lack of safety due to the hydrogen produced which accumulates under the lid and the high level of maintenance necessary to monitor the purity of the oil and maintain its dielectric properties.

To eliminate these disadvantages (hazards, large devices), manufacturers have developed low oil volume circuit breakers.

■ Low oil volume circuit breakers

The arc and the bubble are confined in an insulating breaking chamber. The gas pressure increases as the arc passes through a

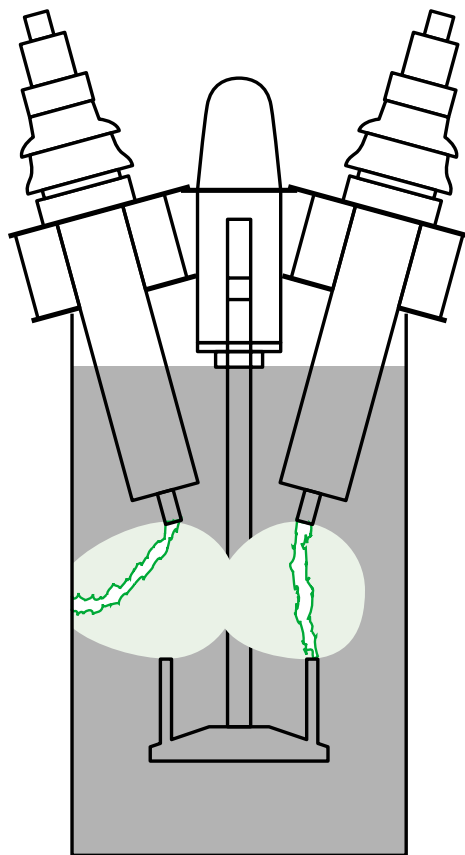

Fig. 25 : cross sectional diagram of high oil volume circuit breakers.

successive set of chambers, then it expands through a duct in the arcing zone when the current passes to 0. The latter is therefore energetically swept, thus restoring the inter-contact dielectric properties.

□ Impact of the current value on breaking capacity

For large currents, the quantity of hydrogen produced and the corresponding pressure increases are very high. In consequence the minimum arcing times are short.

On the other hand, for small currents the pressure increases are slight and the arcing time is long. This arcing time increases up to a critical level where it becomes difficult to accomplish breaking. Complementary puffer mechanisms at the end of the sequence can improve this point.

□ Main characteristics of low oil volume circuit breakers

Short-circuit current or rated current values require the mobile contact to have a minimal diameter. The length of the breaking chamber and the travel of the mobile components are practically proportional to the applied voltage. To avoid excessive pressure, the minimum arcing time to break a high current must be less than 10 ms and it must remain less than 40 ms for critical currents.

The insulating enclosure of the breaking chamber must also be designed to withstand the much higher pressure caused by consecutive faults, since the reduction of pressure requires approximately one second.

However, despite the reduction in the volume of oil, this technique still has certain drawbacks:

- Oil breakdown is not reversible.
- Oil breakdown and contact wear deteriorate dielectric strength thus causing supplementary maintenance costs.
- In the case of quick reclosing the pole remains at a high pressure and its breaking capacity is reduced.
- The risk of explosion and fire is not completely eliminated.

Fields of application for breaking in oil

This breaking technique has been widely used in electrical energy transmission and distribution. It is progressively being replaced by vacuum and SF₆ breaking techniques which do not have any of the disadvantages detailed in the preceding paragraphs.

3.4 Breaking under vacuum

The dielectric properties of vacuum have been known for a long time and have been used e.g. in vacuum bulbs and x-ray tubes. The use of vacuum in switchgear had been considered as early as 1920, but it was never applied at an industrial level until 1960 because of technological contingencies. Since the 1970s, the vacuum technique has been increasingly used due to the advantages that it offers: reduced dimensions, improved safety and greater endurance.

Dielectric properties of vacuum

In theory the vacuum is an ideal dielectric medium: there is no substance therefore there is no electrical conduction. However, the vacuum is never perfect and in any case has a dielectric strength limit.

In spite of this, a true “vacuum” offers outstanding performance levels: at 10^{-6} bar pressure, dielectric strength in a uniform field can reach a peak value of 200 kV for an inter-electrode distance of 12 mm.

The mechanism at the origin of dielectric breaking under vacuum is linked to cold electronic emission phenomena, without any ionization snowballing effect. This is why the dielectric strength is almost independent of pressure as soon as the latter is less than 10^{-6} bar. It then depends on the nature of the materials, electrode shape (in particular the presence of points or asperities) and inter-electrode distance. The shape of the curve of the breakdown voltage as a function of the inter-contact distance (see fig. 21) shows why the applicational scope of vacuum technology remains limited in terms of voltage. In fact the required distances for dielectric strength increase quite quickly as soon as the voltage exceeds 30 to 50 kV which leads to prohibitive costs in relation to other technologies. In addition, more x-rays would be emitted at higher voltages.

The vacuum breaking mechanism

Breaking under vacuum is fairly unique due to the specific characteristics of the arc under vacuum.

■ Electrical arcing under vacuum

The arcing column is made up of metal vapor and electrons coming from the electrodes as opposed to the other breaking techniques previously

discussed where this column is mainly made up of inter-contact gas ionized by collisions. It can occur in two ways, diffused arcing or concentrated arcing, depending on the current intensity that is present.

□ For high current values ($\geq 10,000$ A) the arc is concentrated and single, as in traditional fluids (see fig. 26a). Cathodic and anodic spots of several mm^2 are raised to extremely high temperatures. A fine layer of contact material is vaporized and the arc develops in a metal vapor atmosphere which occupies all of the space. When the current decreases, these vapors condense on the electrodes themselves or on the metal screen placed for this purpose. In this arrangement, arcing voltage can reach 200 V.

□ For current values less than a few thousand amperes, this arc becomes a diffuse shape. It is made up of several arcs separated from one another and conical in shape with the peak at the cathode (see fig. 26b). The cathodic roots of the arcs, called spots, have a very small surface area (10^{-5} cm^2) and current density is very high there (10^5 to 10^7 A/cm^2). The extremely high local temperature (3,000 K) leads to very intense combined thermo-electronic / field effect emission, though the evaporation of contact material remains limited. The current is therefore basically caused by the flux of electrons. The positive metal ions produced at the cathode have sufficient kinetic energy (between 30 and 50 eV) that they fill all of the space up to the anode. Thus they neutralize the inter-contact space charges, resulting in a low potential gradient and low arc voltage (80 V maximum).

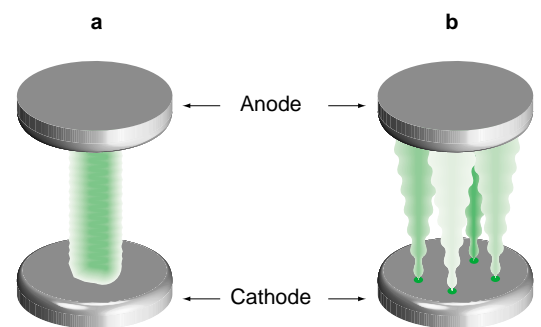

Fig. 26 : concentrated arcing [a] and diffused arcing [b].

■ Passing to 0 current

In a diffuse arcing arrangement, either obtained instantly or long enough after a single concentrated arc so that the metal vapor has had time to condense, breaking occurs easily at zero current.

In fact, when the current nears zero, the number of spots decreases until the last one which disappears when the energy provided by the arc is no longer sufficient to maintain a high enough temperature at the foot of the arc. The abrupt extinction of the last spot is the reason behind the chopping phenomena frequently encountered with this type of technology. It should be noted that at voltage reversal, the anode becomes a cathode, but since it is cold it cannot emit electrons. This thus corresponds to an excessively small deionization time constant. Vacuum devices can in consequence break currents with extremely high TRV gradients as well as high frequency currents. For high currents, an arc plasma may remain at 0 current and breaking becomes uncertain. It is therefore essentially the density of the residual metal vapor which determines the breaking capacity.

■ Re-ignition and re-striking phenomena

These occur when the contacts release too much metal vapor. We consider that if vapor density after zero current exceeds $10^{22}/\text{m}^3$ the probability of breaking is almost non-existent. Generally speaking, these phenomena are almost impossible to reproduce and difficult to model. Numerous tests are then required to validate the designs. In particular, dielectric failures can be observed late after breaking, eventually becoming spurious, linked to the presence of metal particles or condensation products.

The various types of vacuum breaking technology

All manufacturers have been confronted with the same requirements:

- reducing current chopping phenomena to avoid overvoltage problems,
- avoiding early erosion of the contacts to maintain greater endurance,
- delaying the appearance of the concentrated arc state to increase the breaking capacity,
- limiting the production of metal vapor to avoid re-striking,
- maintaining the vacuum, essential to retaining breaking properties, throughout the device's life.

They have developed mainly in two ways: arc control by magnetic field and contact material composition.

■ Choice of magnetic field

Two types of magnetic fields are used: radial or axial.

□ Radial magnetic field technology (see fig. 27)

The field is created by the current circulating in the electrodes designed for this purpose. In the case of concentrated arcing, the roots of the arc move in a circular motion, the heat is uniformly distributed limiting erosion and metal vapor density. When the arc is diffused, the spots move freely on the surface of the cathode as if it were a solid disk.

The fairly complex dielectrode shapes used with this technology make dielectric strength between electrodes more difficult.

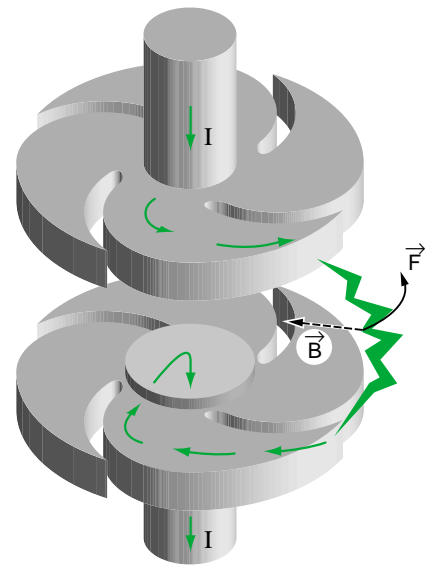

Fig. 27 : contacts creating a radial magnetic field. The arc obeys electromagnetic laws, therefore it moves from the center to the outside of the "petals".

□ Axial magnetic field technology (see fig. 28)

The application of an axial magnetic field requires the ions to take a circular trajectory which stabilizes the diffuse arc and delays the appearance of the concentrated state. The appearance of the cathodic spot is avoided, erosion is limited and this enables fairly high breaking capacities to be reached.

This magnetic field can be generated by internal or external bulb windings in which the current flows permanently. Internally they must be protected from the arc.

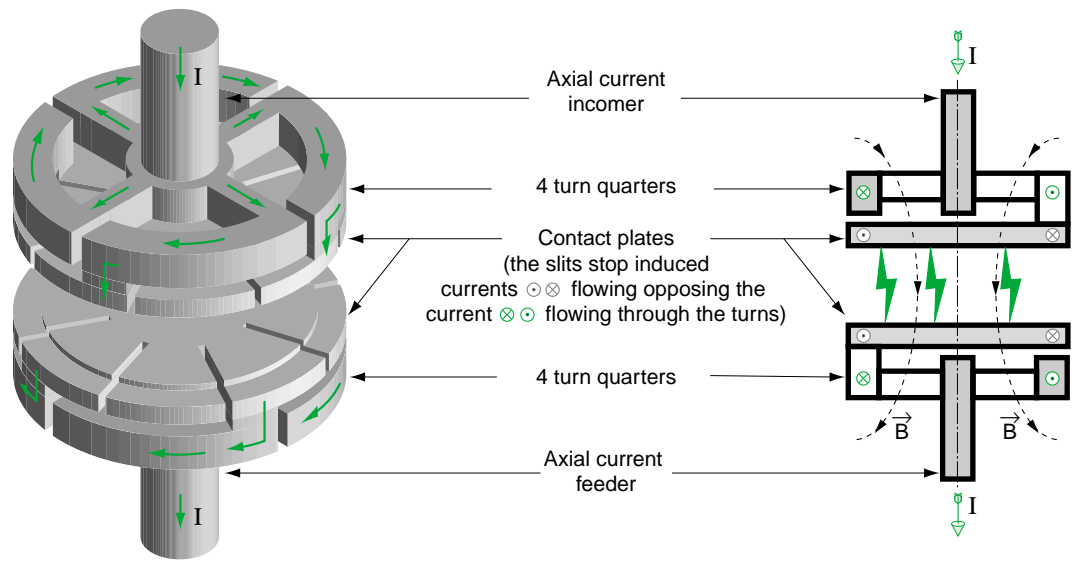

Fig. 28 : contacts creating an axial magnetic field.

Externally this risk is eliminated, but in this case, dimensions are larger and limits could arise due to the risk of the turns over-heating.

The table in **figure 29** compares both of these technologies.

■ Choice of materials

In order to maintain the quality of the vacuum, it is essential that the materials used for the contacts and the surfaces in contact with the vacuum be very pure and gas-free.

The materials that the contacts are made of is equally important since the saturating vapor pressure in the bulbs must not be too high nor too low:

	Radial field	Axial field
Contact resistance/temperature	+	-
Arcing voltage	-	+
Contact erosion	-	+
Breaking capacity/diameter	=	=

Fig. 29 : table comparing radial field and axial field technology.

□ High metal vapor pressure enables arc stabilization and limits current chopping phenomena (overvoltages).

□ In contrast, low metal vapor pressure is more favorable to the interruption of high currents. Furthermore it is necessary for its resistance to be low, for it to have a low tendency to weld and good mechanical strength.

Copper/chrome alloy contacts (50-80 % Cu, 50-20 % Cr) are mainly used in circuit breakers due to their corrosion resistance, their low electrical resistance and their low vapor pressure.

Other materials such as copper/bismuth (98% Copper, 2% Bismuth) or more recently Ag/W/C are used in high switching rate devices (e.g. contactors) since they do not cause chopping and have a low tendency to weld.

Concerning the other components in contact with the vacuum, ceramic materials used with the high temperature welding process are for the moment the most suitable to maintain a high vacuum level (pressure usually less than 10^{-6} mbar).

■ Chamber and breaking device design

The key constraint is that of sealing the bulb under vacuum: e.g. mobile inserting parts must be avoided.

Particle sensitivity and the possibility of cold welding means that sliding contacts are not used under vacuum. Consequently, the contacts are

simply placed end to end and the operating energy for such devices is therefore low (30 to 50 J). On the other hand, contact pressure must be high in order to minimize contact resistance and avoid separation of the contacts when a short-circuit current passes. The required contact pressure leads to high mechanical stresses.

Considering the small insulation distances under vacuum and the simplicity of the mechanisms, bulbs can be very compact. Their volume is a function of the breaking capacity (bulb diameter) however it is the dielectric strength of the external enclosure which becomes important in defining the device size.

This technology is now well mastered by major manufacturers and the devices have a life-expectancy greater than 20 years. It must be noted that permanent monitoring of the vacuum in operation is not possible since it requires a suitable metering device and de-energizing of the equipment. The predictive maintenance required, for accidental leaks, in order to monitor the reliability of the MV electrical switchboards is therefore not appropriate with this technology.

Fields of application for vacuum breaking

This breaking technique currently enables devices to be produced with great electrical endurance, and greatly increased TRV gradients.

This technique is most widely used in MV: general purpose circuit breakers are now available for various applications with all of the usual breaking capacities (up to 63 kA). They are used for protection and control of:

- overhead cables and lines,
- transformers,
- single bank capacitors,
- shunt motors and inductances.

They are particularly well suited for controlling arcing furnaces (high electrical endurance) but must be used with care for controlling parallel connected multi-bank capacitors.

This technology is also used for contactors which require high endurance, but rarely for switches for economic reasons.

In low voltage the use of this technique has remained marginal for reasons of cost and the absence of limiting power. Generally speaking, in LV its use is limited to the range between 800 and 2,500 A rated current and for breaking capacities less than 75 kA.

High voltage applications (U to 52 kV) remain for the future.

Comments :

■ When breaking capacitive current, post-breaking dielectric strength under vacuum is random, and leads to a high risk of re-striking. Vacuum circuit breakers are therefore poorly suited to protection of capacitive networks with voltages greater than 12 kV or those containing capacitor banks .

■ For vacuum contact type switches: there is a risk of welding the contacts after closing under short-circuit conditions. This is the case in certain circumstances e.g. fault locating or during standards testing cycles.

In fact, welding occurs when the contacts are closed under load. When consequently opening under no load, the lack of arcing means that the roughness, that remains from the breaking of the weld, is not eliminated. This deterioration of surface condition makes pre-arcing even easier during successive closures and increases the degree of the welding, with the risk of definitive welding taking place.

The use of these switches therefore requires certain precautions.

■ For motor control: it is necessary to take special precautions due to the fact that the circuit breakers or contactors are breaking high frequency currents (re-ignition phenomena) which therefore cause overvoltages. Even though there exist specific devices, it is preferable to associate these circuit breakers with ZnO type overvoltage protection devices.

3.5 Breaking in SF₆

Sulfur hexafluoride -SF₆-, is a gas that is appreciated for its many chemical and dielectric qualities. The breaking technique using this gas was first developed in the 1970s similarly to vacuum-type breaking.

Properties of SF₆

- Chemical properties

In its pure state SF₆ is a non-polluting colorless, odorless, unflammable and non-toxic gas. It is insoluble in water.

It is chemically inert: all chemical bonds on the molecule are saturated and it has a high dissociation energy (+1,096 kJ/mol) as well as a high evacuation capacity for the heat produced by arcing (high enthalpy).

During the arcing phase, in which the temperature can reach between 15,000 K and 20,000 K the SF₆ breaks down. This decomposition is virtually reversible: when the current is reduced the temperature is reduced and the ions and electrons can reform to make the SF₆ molecule.

A small number of by-products are obtained from SF₆ breakdown in the presence of impurities like sulfur dioxide or carbon tetrafluoride. These by-products remain confined in the bulb and are easily absorbed by active compounds, such as aluminium silicate, which are often placed in the breaking environment.

IEC report 61634 on the use of SF₆ in breaking switchgear gives standard values which can be encountered after several years of use. The quantities produced remain low and are not hazardous for people or the environment: air (a few ppmv), CF₄ (40 ppmv to 600 ppmv), SOF₂ and SO₂F₂ (in negligible quantities).

- Physical properties
- Thermal properties

The thermal conductivity of SF₆ is equal to that of air but research on SF₆'s thermal conductivity curve at high temperature reveals a peak at SF₆'s dissociation temperature (see fig. 30).

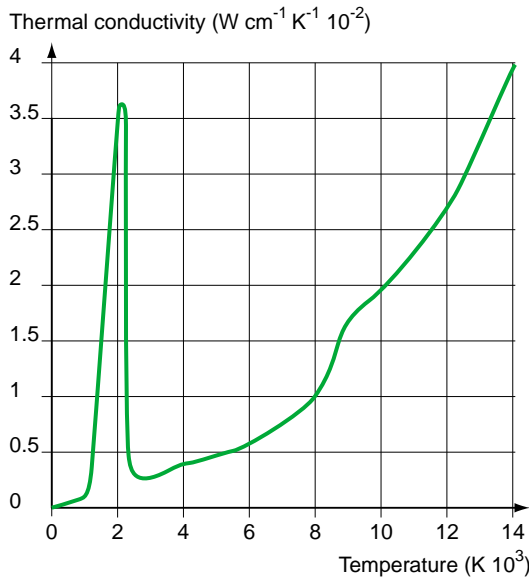

Fig. 30 : SF₆ thermal conductivity curve as a function of temperature.

- Dielectric properties

SF₆ has a very high dielectric gradient due to the electronegative properties of fluorine (see fig. 21):

- The life span of the free electrons remains very low and with the SF₆ molecules they form heavy ions with low mobility. The probability of dielectric failure by a snowballing effect is thereby delayed.
- This gives this medium an extremely low de-ionization time constant of 0.25 ms (see fig. 19).

The SF₆ breaking mechanism

■ Electrical arcing in SF₆

Thermal study of electrical arcing has enabled it to be described as being formed by a dissociated SF₆ plasma, in a cylindrical shape, made up of a very high temperature core surrounded by a colder sheath of gas. The core and the sheath are separated by a temperature difference related to the dissociation temperature of the molecule. Around 2,000°C this threshold remains unchanged as the current intensity varies (see fig. 31). During this arcing phase the sum total of the current is carried by the core since the threshold temperature at this stage is less than the minimum ionization temperature and the external sheath remains insulating.

The characteristic magnitudes of the arc depend on the type of breaking used (self-compression, rotary arc, self-expansion) and are given in the paragraphs discussing each of these breaking types.

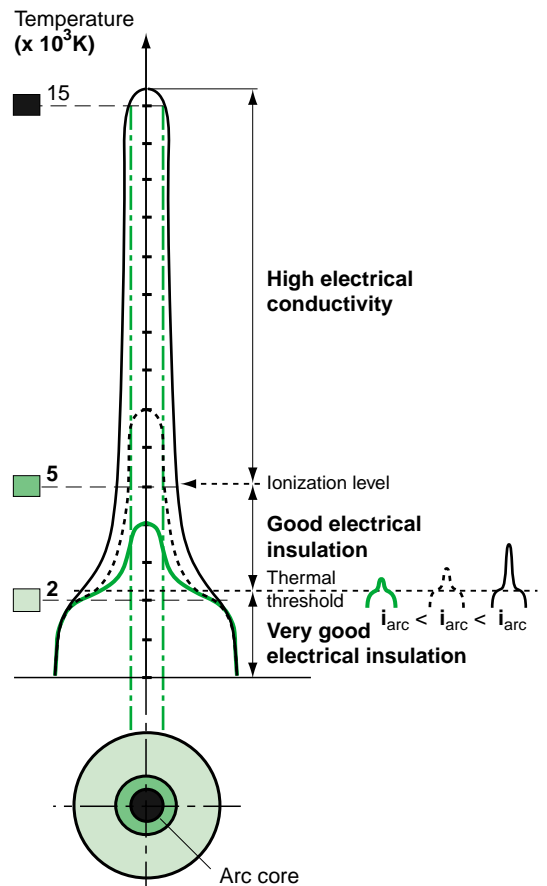

Fig. 31 : temperature distribution curve of an arc contained in a cylindrical tube filled with SF₆.

■ Passing to 0 current

With the decrease in current, the temperature of the core drops and therefore electrical conductivity also begins to fall. Approaching zero current, the thermal exchanges between the sheath and the core become very high. The former disappears leading to the disappearance of conductivity with a time constant that is extremely low (0.25 ms) but not sufficient to break high frequency currents (no re-ignition).

Various types of SF₆ breaking technology and their fields of application

In SF₆ devices, the contacts are located within a sealed enclosure filled with gas in which the pressure varies according to voltage and design parameters. These enclosures are generally sealed for life since the leakage rate can be kept to a very low level. Pressure and / or density measurement systems can be installed which enable permanent monitoring of gas pressure in the enclosure.

Several types of SF₆ device technology exist, differing in terms of arc cooling methods and each having varying characteristics and applicational fields.

■ Self compression breaking

In this type of circuit breaker, the arc is blown out by the release of a volume of SF₆ compressed by a piston action: when the device opens, a cylinder attached to the mobile contact moves and compresses a volume of SF₆ (see fig. 32a). A puffer nozzle channels the gas in the arc axis which is then ejected in the hollow contacts.

At high currents, the arc causes a blocking effect which contributes to the accumulation of compressed gas. When the current nears zero, the arc is first of all cooled then extinguished due to the injection of new SF₆ molecules.

The average value of the arc's voltage is between 300 and 500 V.

This technology enables all currents up to the breaking capacity to be broken without any problems and without any critical current, since the energy required to blow out the arc is produced by the mechanical order which is independent of the current to be broken.

□ Characteristic values

The relative pressure of SF₆ generally used varies from 0.5 bar (16 kA, 24 kV) to 5 bars (52 kV), which enables the achievement of sealed leak-proof enclosures with guaranteed safety.

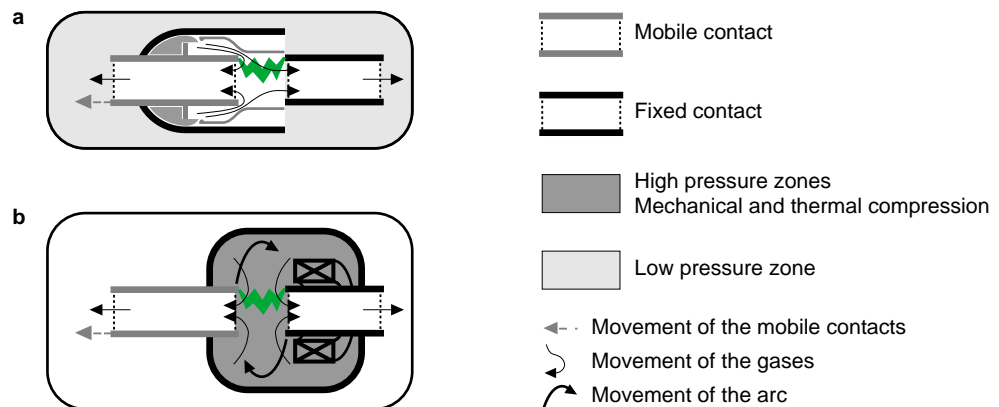

Fig. 32 : principles of self-compression [a], and rotary arc [b] breaking.

The factors influencing the dimensions of the breaking chamber are the following:

- The test voltage withstand of the input/output which determines the insulation distance between the open contacts. It can be constant and of the order of 45 mm depending on the SF₆ pressure used.
- The short-circuit current to be broken determines the diameter of the nozzle and the contacts.
- The short-circuit power to be broken determines the puffer piston dimensions (at 24 kV the volume of gas blast is of the order of 1 liter for a breaking capacity of 40 kA).

The opening energy of 200 J (16 kA) to 500 J (50 kA) remains relatively high despite the compactness of the devices due to the energy required for gas compression.

□ Fields of application for self-compression breaking

The principle of self-compression is the oldest of them all and has been used for all types of general purpose circuit breakers. It involves relatively low overvoltages since there is little chopping phenomena and there is no risk of successive re-ignition.

Self-compression circuit-breakers are well suited to capacitor bank operation since they have a low re-strike probability as well as a high endurance to closing currents.

However, the relatively high operating energy leads to quite high stresses on the operating mechanism and possibly to a limitation in terms of the number of operations.

This technology is still widely used today especially for high intensity devices and voltages greater than 24 kV.

■ Rotary arc breaking

In this technology, the arc cools through its own movement through the SF₆. The high speed rotary movement of the arc (which can exceed the speed of sound) is caused by the magnetic field created by a winding through which the fault current flows.

When the main contacts open, the current is switched to the winding and the magnetic field

appears. The resulting Laplace force accelerates the arc in a circular movement. The arc contacts have the shape of circular tracks which can be either concentric (radial arc and axial field) or face to face as seen in **figure 32b** (axial arc and radial field). The arc is thereby cooled in a uniform manner in the SF₆. The device's cooling capacity therefore depends directly on the value of the short-circuit current which gives these devices a gentle breaking capacity only requiring low operating energy: the energy required on breaking is completely supplied by the arc and the low currents are broken without chopping or overvoltages.

Because of the quick movement of the arc's roots, hot spots releasing metal vapors are avoided and contact erosion is minimized in particular in the case of axial geometry.

It must be noted that nearing zero current, the magnetic field is reduced. It is important that it keeps a non-zero value in such a way that the arc is kept moving in the cold SF₆ when the TRV appears, thereby avoiding the appearance of critical currents. This is achieved by inserting short-circuit rings which force the magnetic field to be in slight phase displacement relative to the current.

□ Characteristic values

In MV, the arc rotating in SF₆ has a voltage of between 50 and 100 V for a length of 15 to 25 mm.

Due to the low breaking energy, the devices are very compact even at a relatively low filling pressure (of around 2.5 bar) and opening energy is less than 100 J.

□ Fields of application

Rotary arc breaking is well suited to operating devices sensitive to overvoltages such as MV motors and alternators. Its excellent endurance, due to low contact wear and low control energy make it of use in applications with a high number of switching operations (contactor function).

The rotary arc technique used on its own only enables a limited breaking capacity to be achieved (25/30 kA at 17.5 kV) and only applies to voltages less than 17.5 kV.

■ Self expansion

Self-expansion breaking uses the thermal energy dissipated by the arc to increase the pressure of a small volume of SF₆ which escapes through an orifice crossed by the arc (see fig. 33a). As long as the current in the arc is high, it has a blocking effect which prevents the outflow of gas through the orifice. The temperature of the cold gas blocked in the volume increases due to the thermal dissipation of the arc (mainly by radiation), therefore its pressure increases as well. At zero current the plug disappears and the SF₆ expands and blows out the arc. The puffer effect depends on the current value, which enables low control energy and gentle breaking, but with a risk of critical currents as well. These are generally found at approximately 10% of the breaking capacity.

□ Two methods of arc guiding have been developed, mechanical guiding and magnetic guiding, which enable the stabilization of the arc in the puffer zone as well as the elimination of critical currents.

- Mechanical guiding (self-compression type) (see fig. 33b)

The arc is maintained centered between the two contacts by insulating walls confining the gaseous flux in a manner similar to the nozzles used in self-compression.

This technique is safe and simple but it increases the energy required for control. In fact, the presence of these mechanisms in the arc

zone reduces the dielectric performance of the SF₆ during the restoring phase, which leads to an increase in the inter-electrode gap and contact displacement rates, and even the pressure of the SF₆.

- Magnetic guiding (rotary arc type) (see fig. 33c)

An appropriately dimensioned magnetic field enables the centering of the arc in the SF₆ expansion zone while giving it a rapid rotational movement similar to that with rotary arc technology. This technology, which requires expertise in design and simulation, offers the advantage of avoiding having substances other than SF₆ in the arcing zone. Thermodynamic efficiency is optimum and the SF₆ keeps all of its dielectric qualities. Therefore the insulation distances can be reduced to their minimum and the required control energy is low.

□ Characteristic values

For low currents the puffer action is almost non-existent and arc voltage generally does not exceed 200 V.

The bulb filling pressure is close to atmospheric pressure and thermal puffer volume is between 0.5 and 2 liters.

Control energy under 24 kV is less than 100 J. All of these characteristics mean that the self-breaking technique is the best performing technology to date. The breaking capacities can be very high while still having low pressure and control energy, therefore giving great reliability.

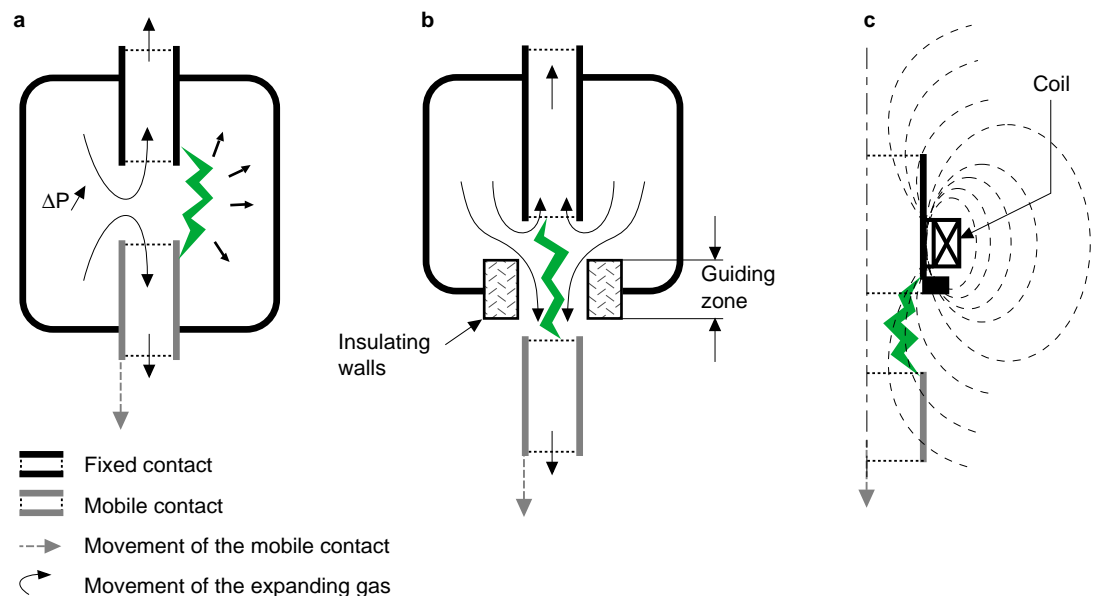

Fig. 33 : self-expansion, its principle [a] and the two methods of arc guiding, mechanical [b] and magnetic [c].

□ Fields of application

This technology, developed for breaking fault currents, is well suited for breaking capacitive currents since it accepts overcurrents and overvoltages. It is also suitable for breaking slightly inductive currents.

Without any additional means thermal expansion devices have limited breaking capacity and operating voltages. The self-expansion technique is often associated with rotary arc or

piston assisted self-compression. It is then used in devices intended for MV and even in HV for all applications.

The performance levels achieved by combining thermal expansion and rotary arcing are such that the technique is considered for use in circuit breakers used in extremely demanding applications, e.g. to protect power station alternators (high asymmetry and TRV) or for applications requiring great endurance.

3.6 Comparison of the various techniques

Currently in the LV sector, magnetic breaking in air is, with the exception of a few rare cases, the only technique used.

In EHV, the SF₆ breaking technique is practically the only one used.

In MV applications, where all the technologies can be used, SF₆ breaking and vacuum breaking have replaced breaking in air for reasons of cost and space requirements (see fig. 34), and breaking in oil for reasons of reliability, safety and reduced maintenance (see fig. 35).

Vacuum or SF₆ breaking techniques have similar performance levels and their respective qualities mean that one or other is better suited for certain applications.

According to the country, one or other of these technologies is primarily used mainly for historical reasons or manufacturer's choice.

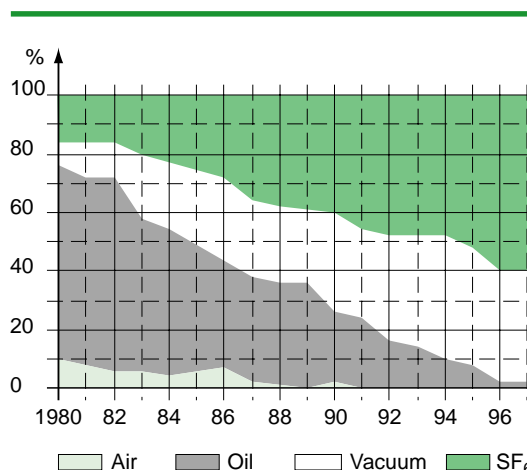

Fig. 34 : development of the MV circuit breaker market in Europe.

	Oil	Air	SF ₆ / Vacuum
Safety	Risk of explosion and fire if increase in pressure (multiple operations) causes failure.	Significant external effects (hot and ionized gas emissions during breaking).	No risk of explosion nor of external effects.
Size	Fairly large device volume.	Installation requiring large distances. (unconfined breaking).	Small.
Maintenance	Regular oil replacement (irreversible oil breaking-down during each break).	Replacement of arcing contacts when possible. Regular maintenance of the control mechanism.	Nothing for the breaking components. Minimal lubrication of the control mechanisms.
Sensitivity to the environment	The breaking environment can be changed by the environment itself (humidity, dust, etc.).		Insensitive: sealed for life type bulb.
Quick cycle breaking	The long pressure reduction time requires de-rating of the breaking capacity if there is a risk of successive breaks.	The slow evacuation of hot air requires the breaking capacity to be de-rated.	Both SF ₆ and the vacuum recover their dielectric properties very quickly: no need to de-rate the breaking capacity.
Endurance	Mediocre.	Average.	Excellent.

Fig. 35 : comparison of performances of various breaking techniques.

The following table **figure 36** summarizes the respective features of each of these two techniques.

□ SF₆ and vacuum circuit breakers are general purpose circuit breakers and can be adapted to all applications.

Technological progress in terms of vacuum bulb production has enabled very reliable and competitive devices to be obtained in the same way as SF₆ devices.

The vacuum breaking technique is easier to implement at low voltages (voltage less than 7.2-12 kV). On the other hand, the SF₆ breaking technique enables higher breaking performances

to be more easily achieved (voltage or short-circuit current).

□ Vacuum technology is widely used in control functions (contactor) (moderate voltage or current, high endurance requirement) despite the precautions to be taken concerning overvoltages.

On the other hand, it is almost non-existent in switch functions for economic reasons; in particular, the excellent dielectric strength of SF₆ after breaking enables a single device to integrate the functions of switching and isolation, which is not possible under vacuum. Today, most major manufacturers use both these breaking techniques in their switchgear according to their requirements.

		SF ₆	Vacuum
Applications	Motors, furnaces, lines, etc.	All. Relatively suited to high breaking performances (I and U).	All. Relatively suited to low voltages and very quick TRVs.
	Circuit breakers, contactors, etc.	All.	Isolating functions are prohibited.
Characteristics	Endurance	Satisfactory for all current applications.	Can be very high for certain special applications.
	Overvoltage	No risk for low inductive currents. Very low probability of re-striking for capacitive currents.	Overvoltage protection device recommended for motor and capacitor bank switching.
	Isolation between contacts	Very stable, enabling isolating functions.	
	Dimension		Very compact at low voltages.
Functioning safety	Loss of tightness	Up to 80% of performances maintained at P _{atm} . Possibility of continuous monitoring.	
	Maintenance	Reduced for the control mechanism. Possibility of permanent monitoring of gas pressure.	Reduced for the control mechanism. Occasional control of the vacuum possible.
	Number of failures	Very low (< 4/10,000), mainly due to the auxiliaries.	Very low if the bulb production procedure is well controlled.

Fig. 36 : compared features of SF₆ and vacuum breaking techniques.

3.7 What possibilities for other techniques?

For several decades, engineers have been seeking to develop circuit breakers without arcs or mobile parts, notably by using electronic components.

Thyristors enable breaking devices to be produced in which the behavior can be near to the ideal switch since they break the current when it passes to zero; furthermore, their endurance is exceptional under normal conditions of operation. Unfortunately, apart from their cost, static components have a few disadvantages:

- high thermal dissipation,
 - high sensitivity to overvoltages and overcurrents,
 - leakage current in a blocked state,
 - limitation in reverse voltage.
- These features make it necessary to combine them with:
- radiators,
 - overvoltage protection devices,
 - ultra-quick fuses,
 - switches or isolators,
 - and of course electronic control systems.

Semi-conductors: thyristors, GTO, IGBT have made enormous progress and are widely used in LV in various applications, e.g. to produce contactors every time the operating rate is very high.

In HV, thyristors are placed in impedance regulation control devices comprising self-reactors and capacitors, in FACTS -Flexible Alternating Current Transmission Systems-, whose role is to optimize and stabilize the network and in Custom Power for distribution networks.

In MV, applications are very rare and static circuit breakers remain in the prototype phase; this is because, in addition to their weaknesses listed above, it is necessary to use several components in series to withstand the rated voltage.

In conclusion, except for very specific applications, static breaking currently does not have a very bright future. Electrical arc breaking currently remains **the** unavoidable solution.

4 Conclusion

Of all the MV breaking techniques only SF₆ and vacuum breaking offer significantly better performance levels.

The choice between vacuum and SF₆ depends entirely on the applicational field and the technological choices made by each country and manufacturer: resulting in the differences in geographic spread of the devices using SF₆ or vacuum breaking techniques.

Currently no other technique capable of replacing vacuum or SF₆ breaking is on the horizon. These two techniques have numerous advantages relative to the older techniques:

- Safety: no risk of explosion or fire and external effects during breaking.
- Compactness: vacuum and SF₆ are very good insulators, thus the devices are not as big.

■ Reliability: few moving parts and low control energy which means high availability, reduced maintenance and a very long life span.

■ Placing these devices in enclosures and the production of very compact ready-made MV switchboards is another important advantage since the breaking capacity is not affected by the presence of metal partitions.

Due to current computing technology, which enables modeling and simulation, switchgear is constantly improving.

However, the most important gains in terms of operational dependability of installations (reliability, safety, maintainability) are related to the widespread use of equipment that is in a factory-made and tested enclosure, associated with the integrated protection, monitoring and control systems.

Bibliography

Standards

- IEC 60034: Rotating electrical machines.
- IEC 60056: High-voltage alternating-current circuit-breakers.
- IEC 60909: Short-circuit current calculation in three-phase AC systems.
- IEC 61233 report: High-voltage alternating current circuit-breakers - Inductive load switching.
- IEC 61634 report: High-voltage switchgear and controlgear - Use and handling of sulphur hexafluoride (SF₆) in high-voltage switchgear and controlgear.

Schneider Electric's Cahiers Techniques

- Analyse des réseaux triphasés en régime perturbé à l'aide des composantes symétriques. B. DE METZ-NOBLAT, Cahier Technique no. 18.
- The breaking process with a Fluarc SF₆ puffer-type circuit-breaker. J. HENNEBERT, Cahier Technique no. 112.
- Calculation of short-circuit currents. B. DE METZ-NOBLAT, G. THOMASSET, R. CALVAS and A. DUCLUZAUX, Cahier Technique no. 158.
- Control, monitoring and protection of HV motors. J.-Y. BLANC, Cahier Technique no. 165.
- Breaking by auto-expansion. G. BERNARD, Cahier Technique no. 171.
- SF₆ properties, and use in MV and HV switchgear. D. KOCH, Cahier Technique no. 188.
- Manœuvre et protection des batteries de condensateurs. D. KOCH, Cahier Technique no. 189.

Various works

- High Voltage Circuit Breakers-Design and Applications-. RUBEN, D. GARZON.
- Disjoncteurs HAUTE TENSION : Comparaison des différents mode de coupure. B. JOYEUX-BOUILLON (GEC ALSTHOM) & J.-P. ROBERT (Merlin-Gerin)
- Disjoncteurs SF₆ : Evolution de 1959 à 1994. D. DUFOURNET, (GEC ALSTHOM- T&D).
- Manœuvre des courants capacitifs - Etat de l'art -. ELECTR n°155, Août 1994.
- Etude des technologies existantes des disjoncteurs de distribution. IREQ, Avril 1991.
- Guide technique du disjoncteur. P. POLO & P. ATTIER, 1993.

Schneider Electric

Direction Scientifique et Technique,
Service Communication Technique
F-38050 Grenoble cedex 9
Fax: (33) 04 76 57 98 60

DTP: AXESS - Saint-Péray (07)
Edition: Schneider Electric
Printing: Imprimerie du Pont de Claix - Claix - France - 1000
- 100 FF -