

Description SysML du ClipFlow

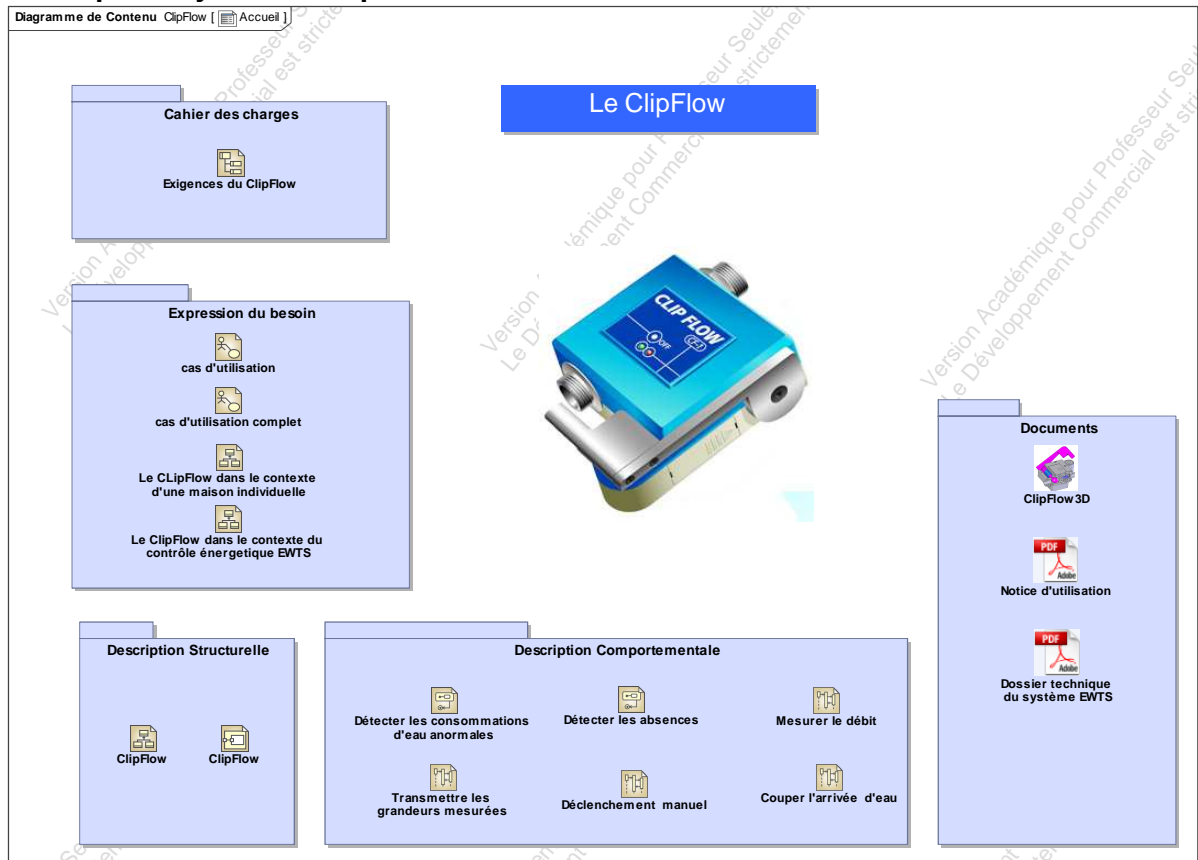

Description SysML du ClipFlow

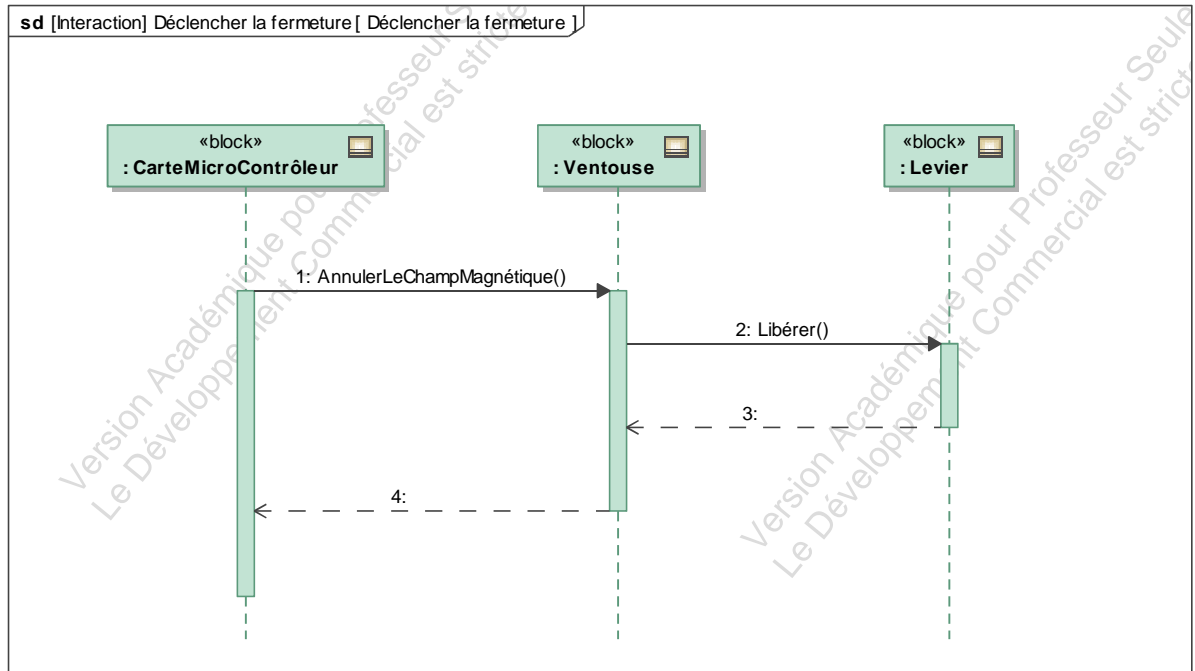

Description SysML du ClipFlow

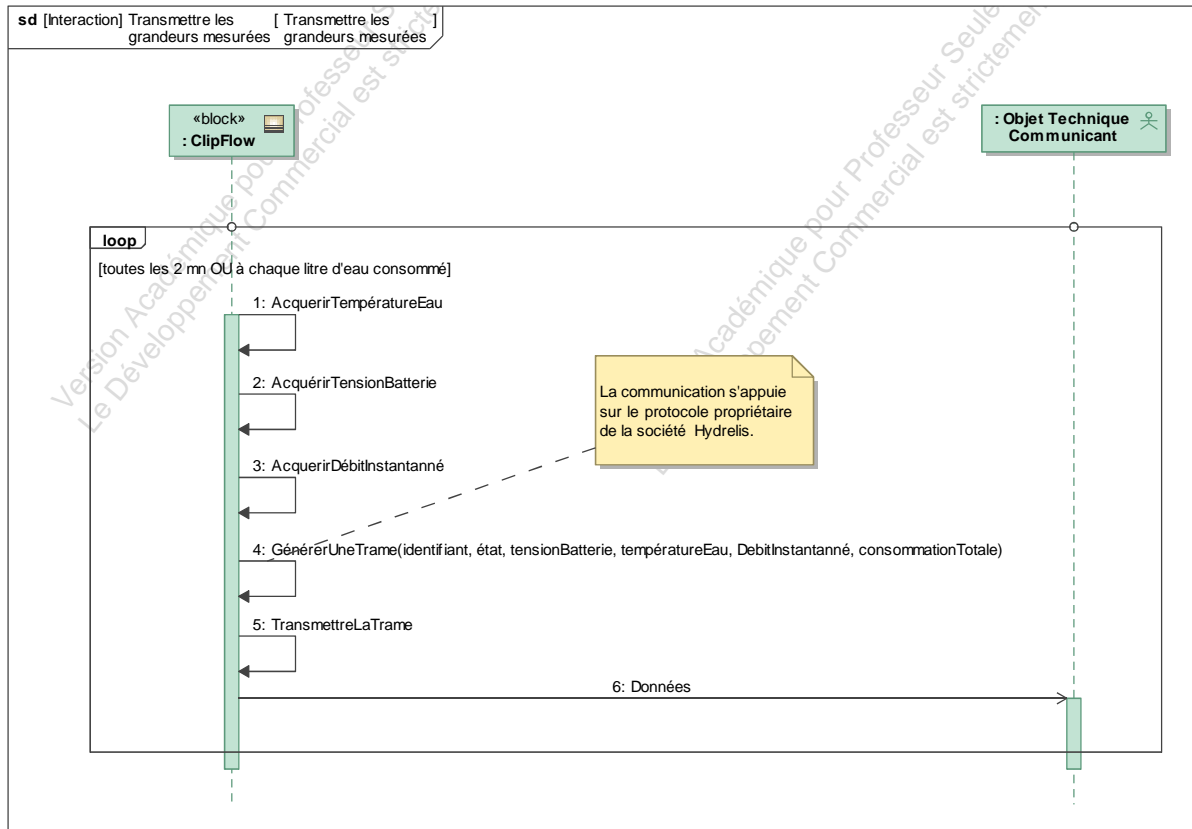

Description SysML du ClipFlow

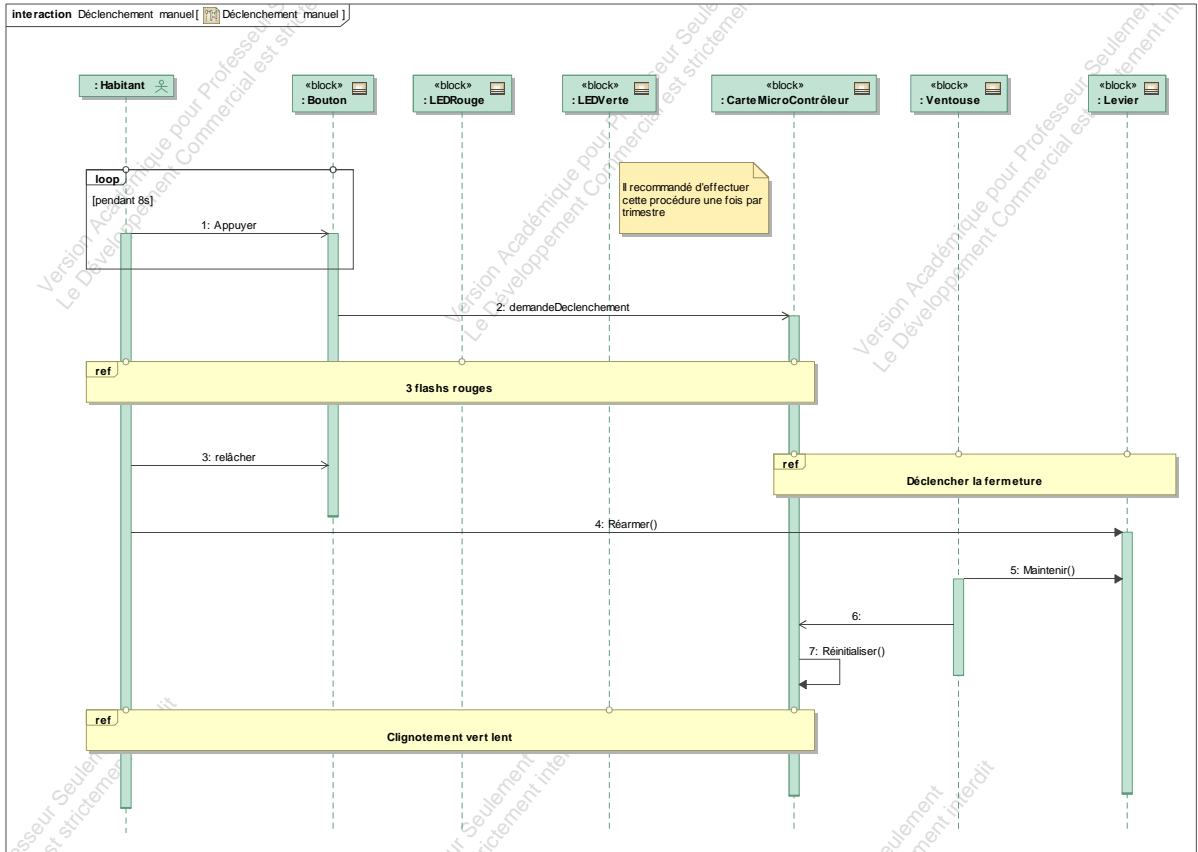

Description SysML du ClipFlow

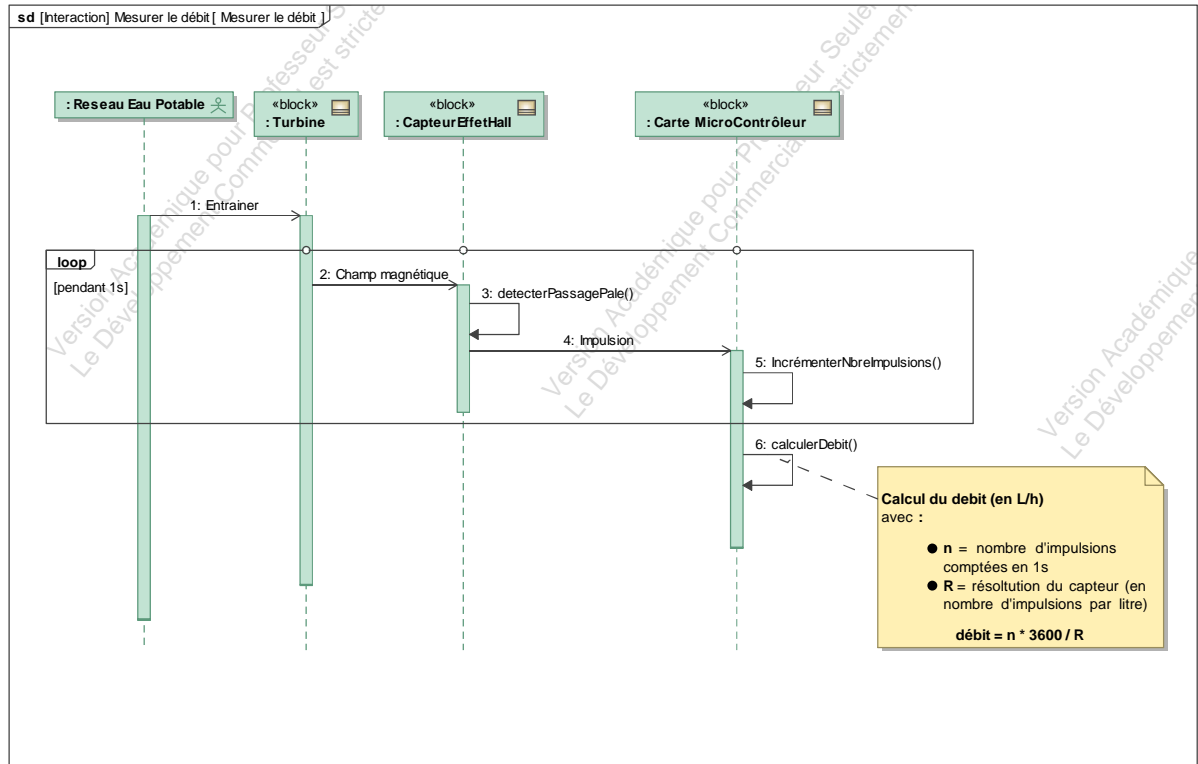

Description SysML du ClipFlow

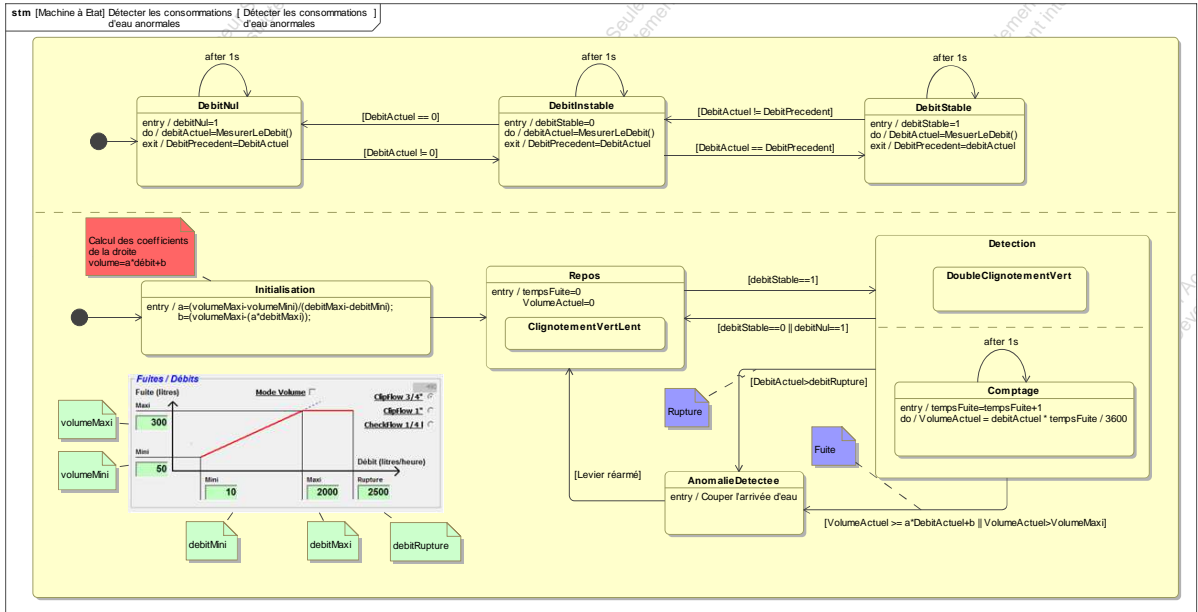

MagicDraw SysML, Détecter les consommations d'eau anormales

Description SysML du ClipFlow

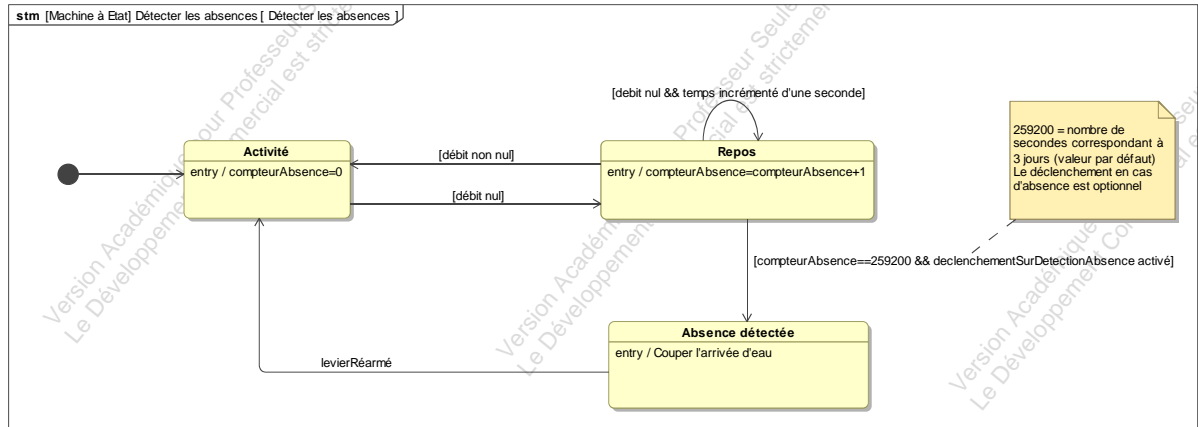

Description SysML du ClipFlow

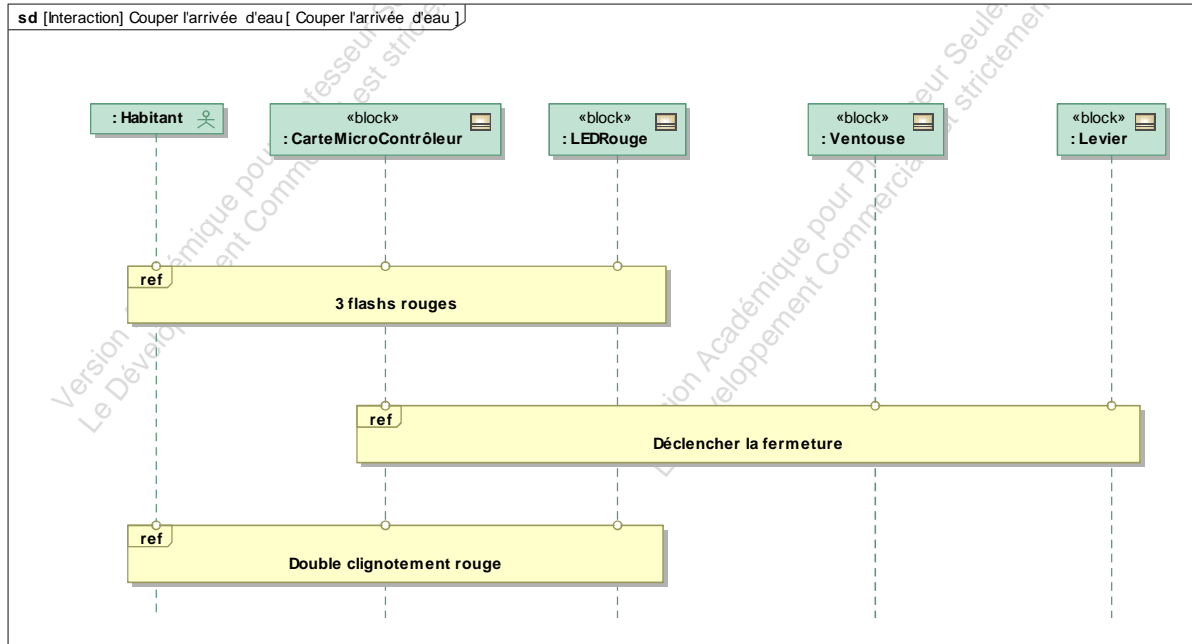

Description SysML du ClipFlow

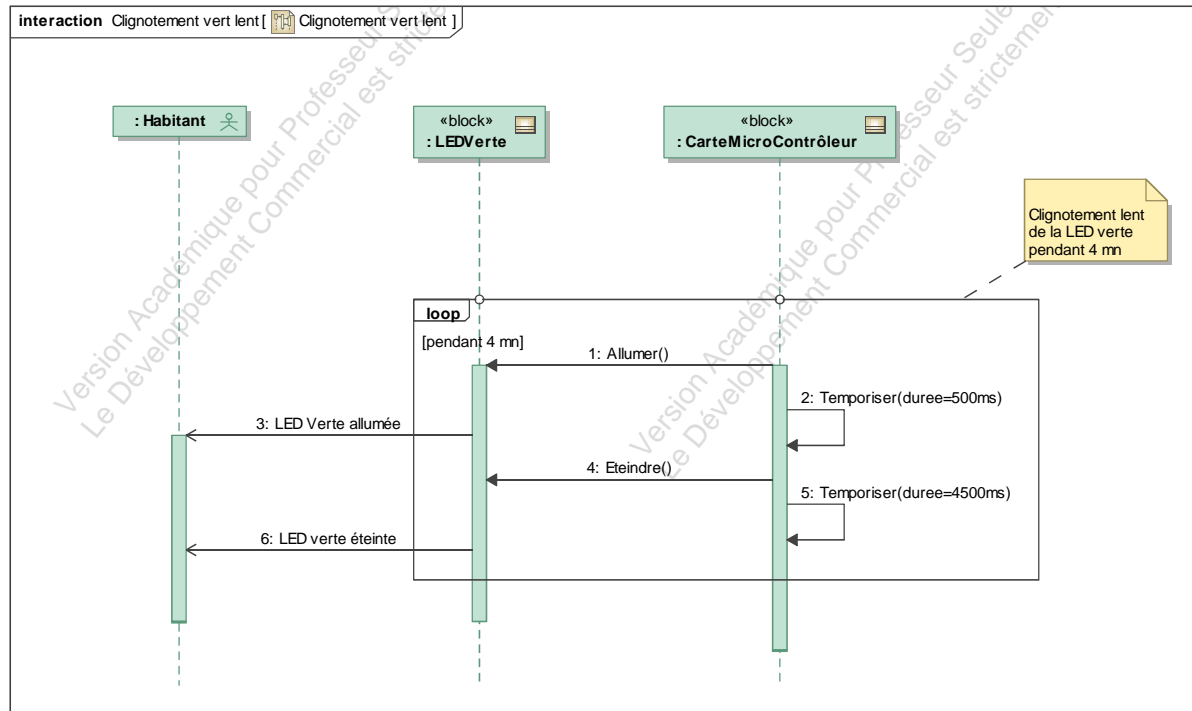

Description SysML du ClipFlow

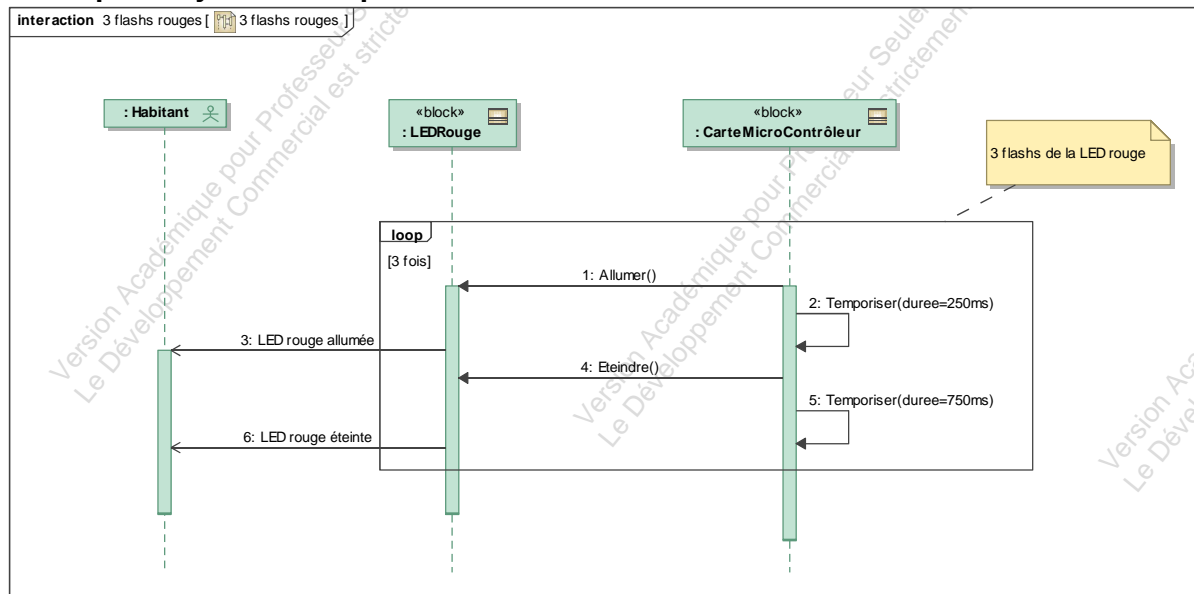

Description SysML du ClipFlow

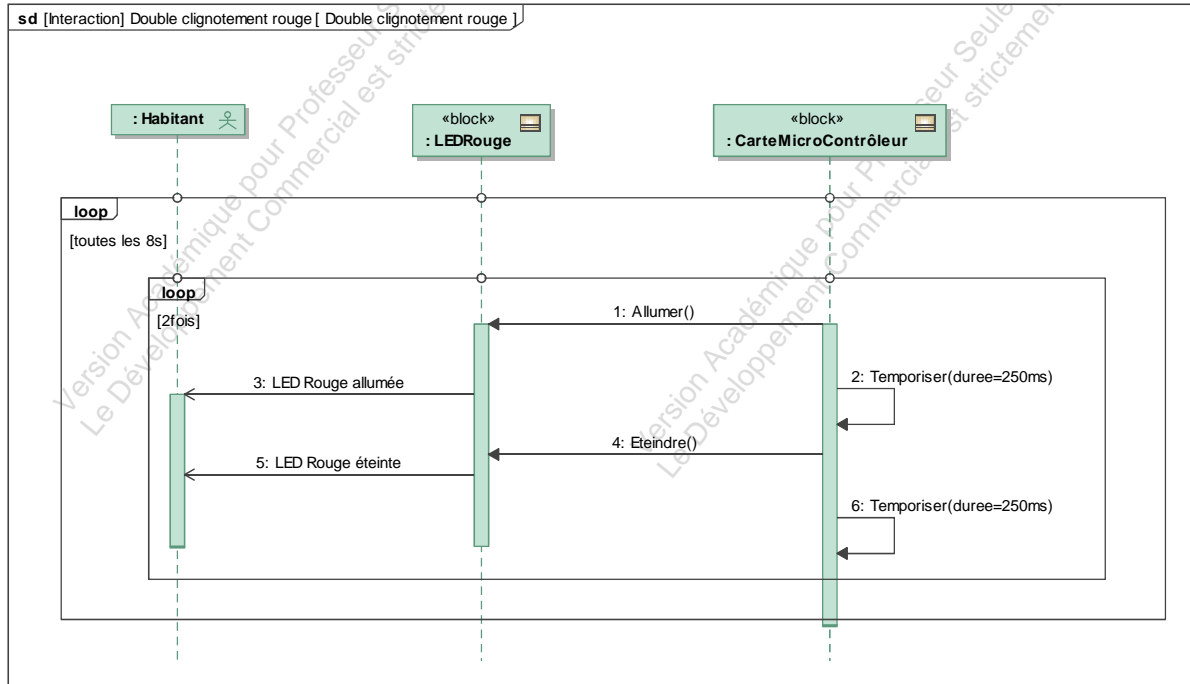

Description SysML du ClipFlow

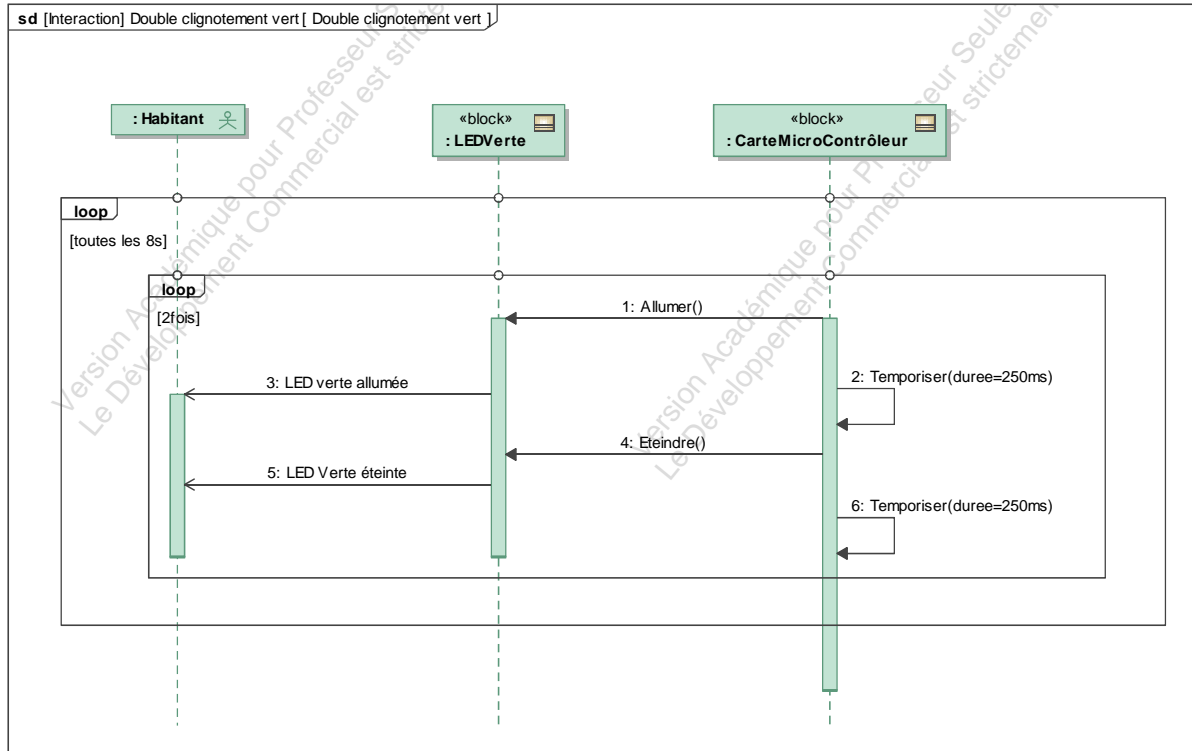

Description SysML du ClipFlow

uc [Paquetage] Expression du besoin [cas d'utilisation complet]

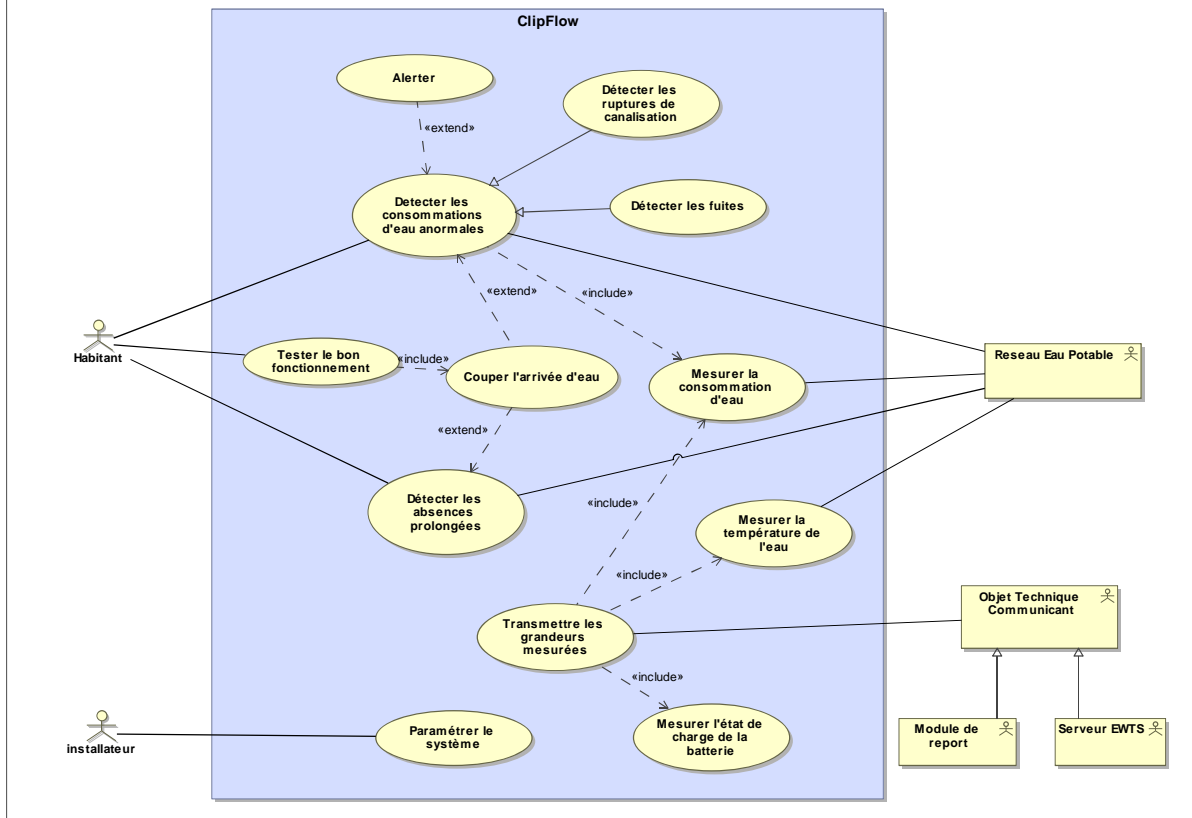

Description SysML du ClipFlow

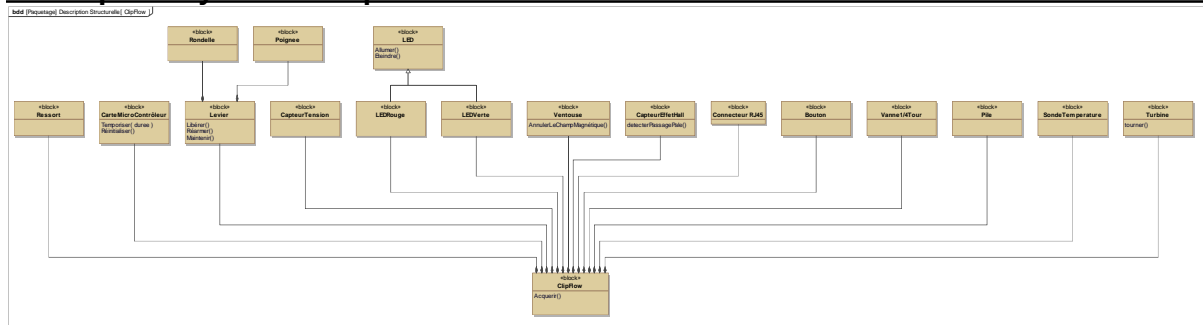

Description SysML du ClipFlow

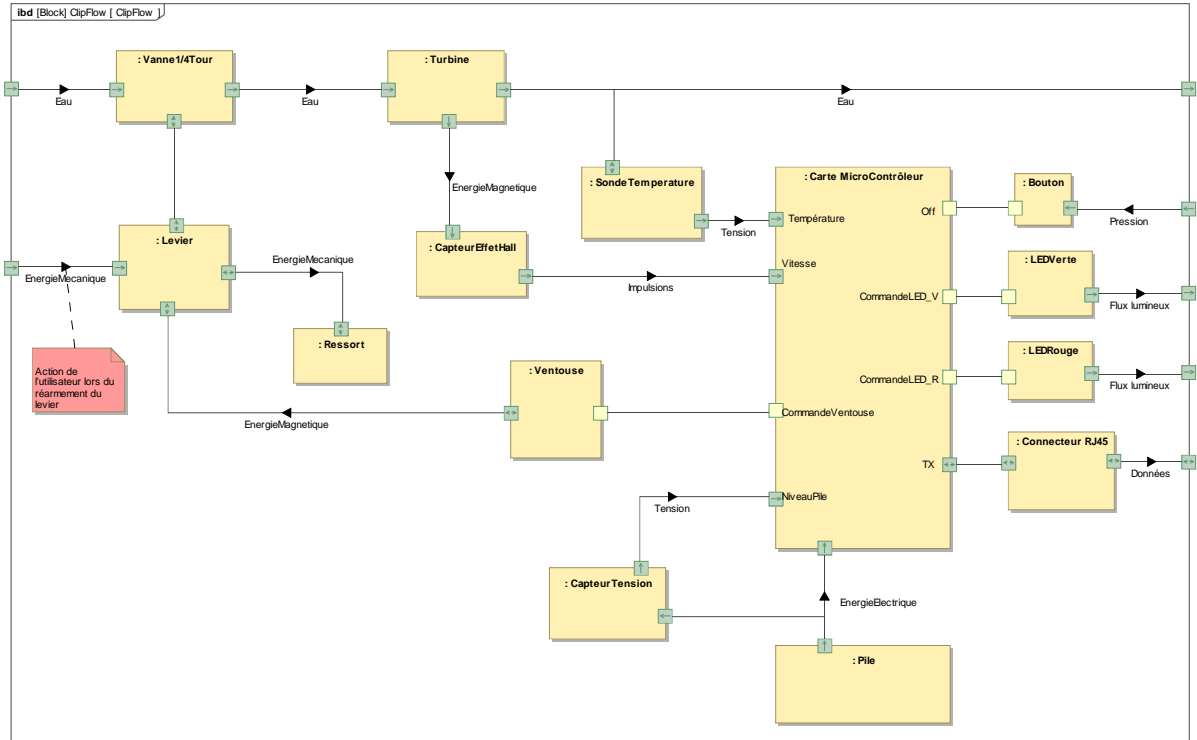

Description SysML du ClipFlow

bdd [Paquetage] Expression du besoin [Le ClipFlow dans le contexte du contrôle énergétique EWTS]

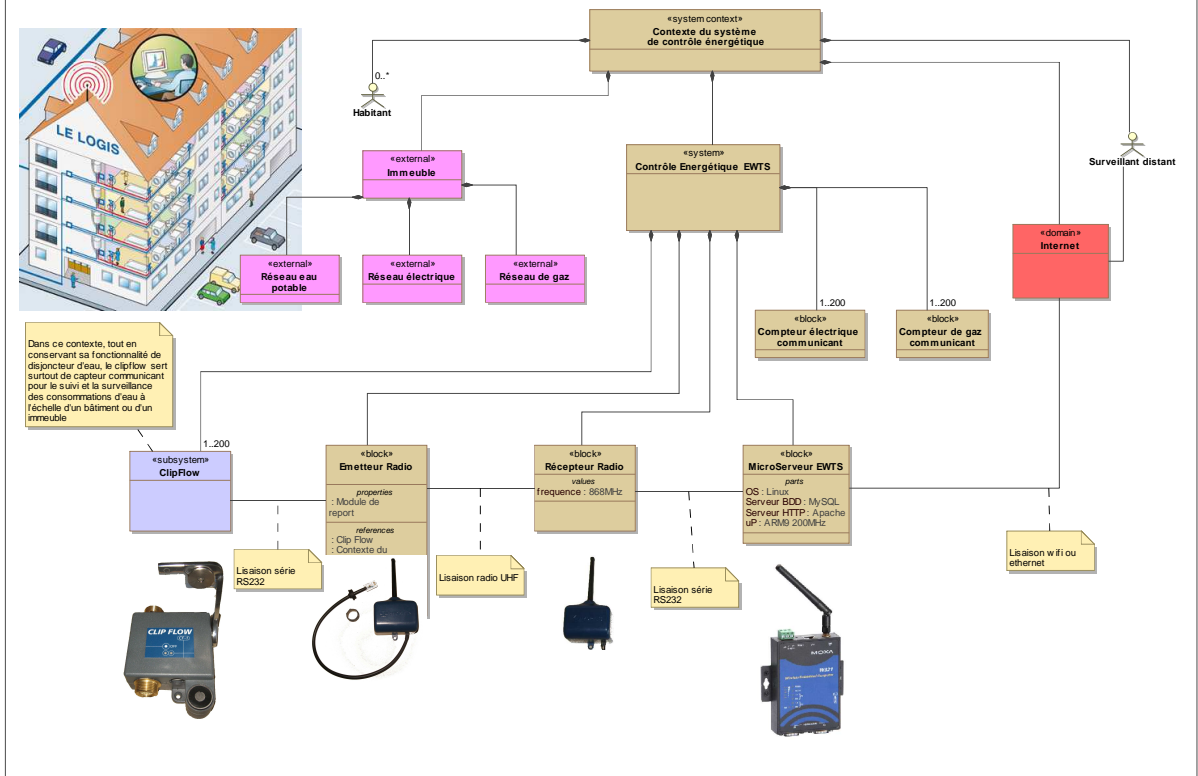

MagicDraw SysML, Le ClipFlow dans le contexte du contrôle énergétique EWTS

Description SysML du ClipFlow

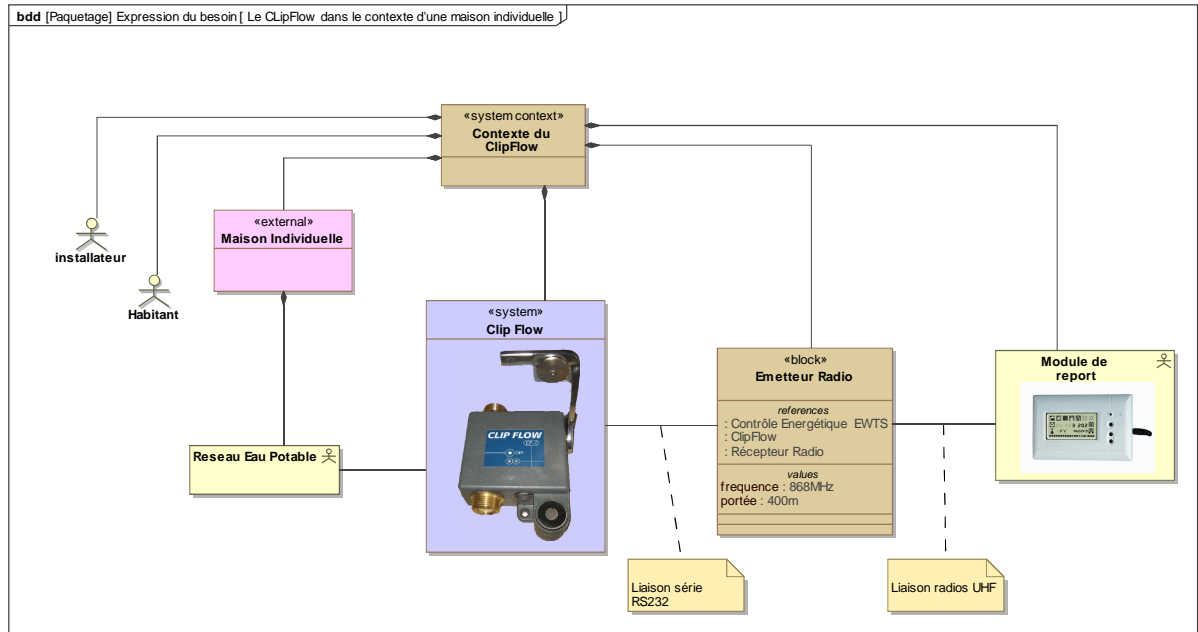

Description SysML du ClipFlow

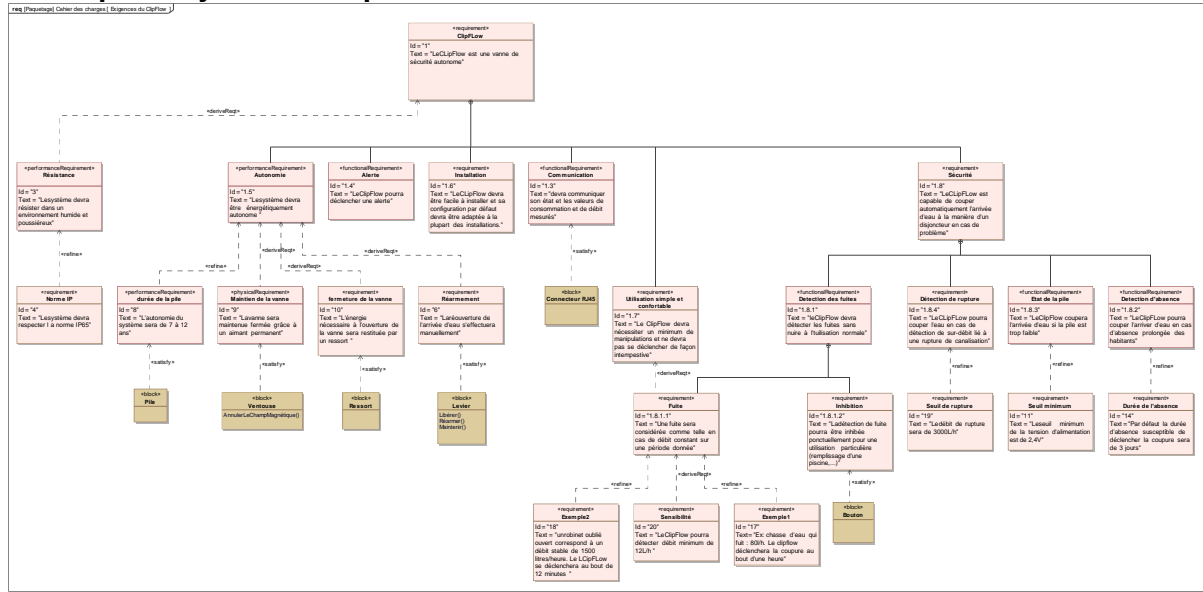

Description SysML du ClipFlow

