



**MINISTÈRE  
DE L'ÉDUCATION  
NATIONALE  
ET DE LA JEUNESSE**

*Liberté  
Égalité  
Fraternité*

# REPÈRES

## CP 2024

**Prénom de l'élève**

**Nom de l'élève**

**Classe de l'élève**



# **SÉQUENCE 1**

---

## **FRANÇAIS**

# Exercise 1

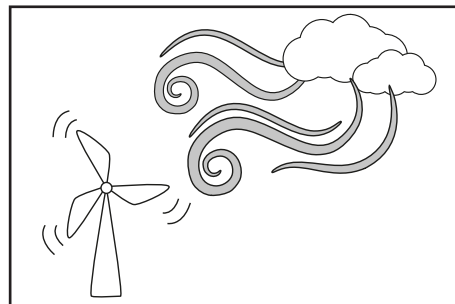
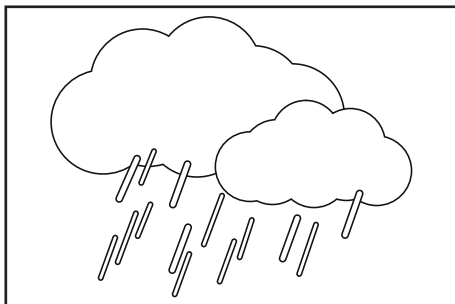
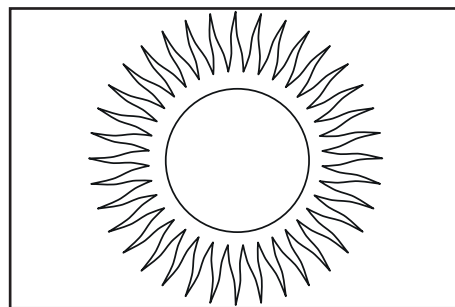
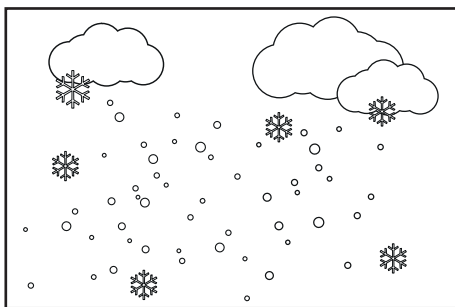
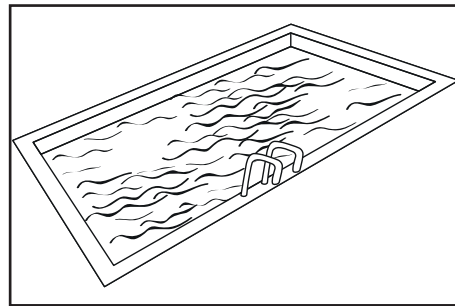
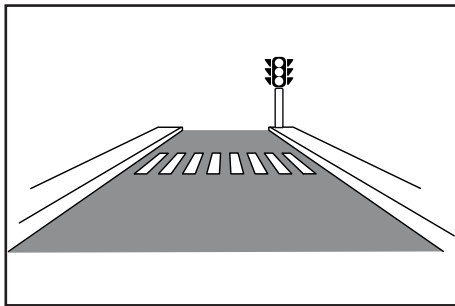
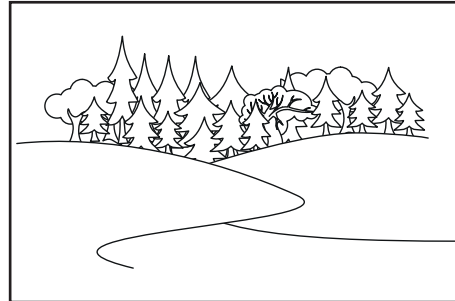

## Exercice 1 (suite)

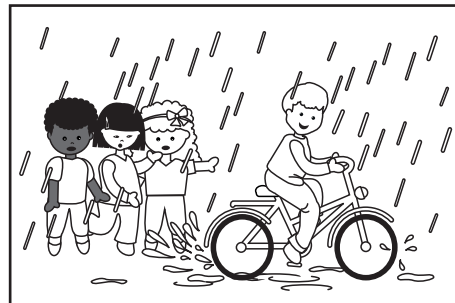
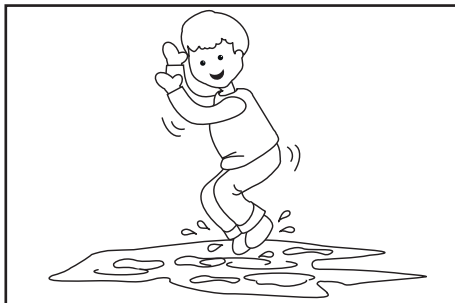
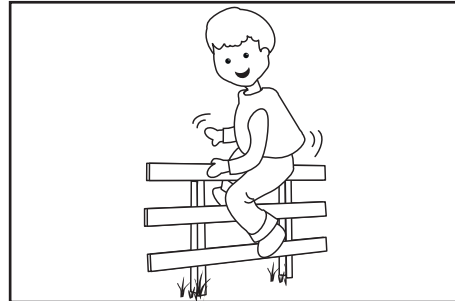
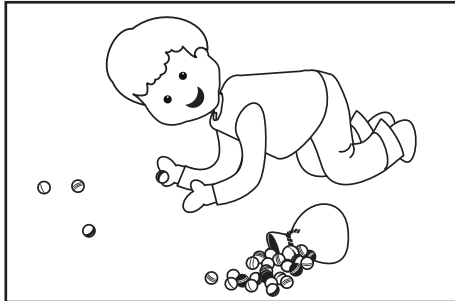

## Exercise 2



l f a e G d

f O A i D g

o i F g a d



E b a e C d

b O A e D c

o e B c a d

## Exercice 2 (suite)

---



E b a e C d

b O A e D c

o e B c a d

---



E b a e C d

b O A e D c

o e B c a d

## Exercice 2 (suite)

---



E b a e C d

b O A e D c

o e B c a d

---



E b a e C d

b O A e D c

o e B c a d



## Exercice 2 (suite)

---



E b a a C d

b O A e D c

o e B c a d

---



R v m n S d

v N M n D o

n r V s m d

### Exercise 3

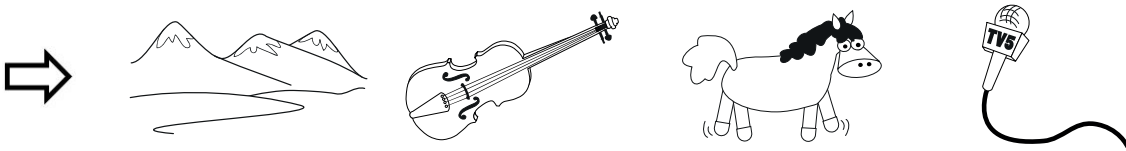
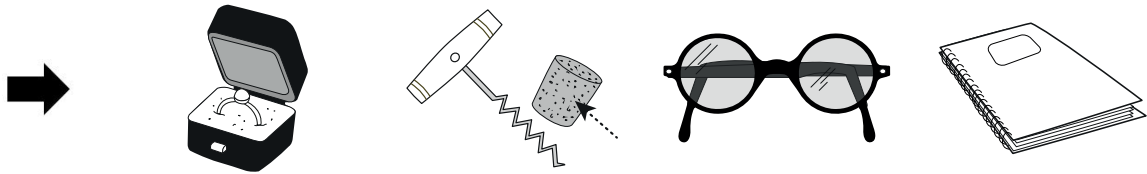
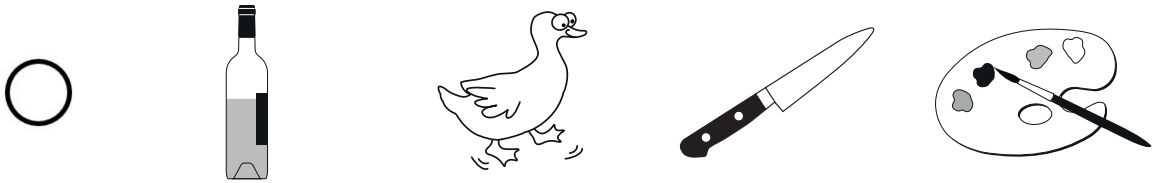

## Exercice 3 (suite)

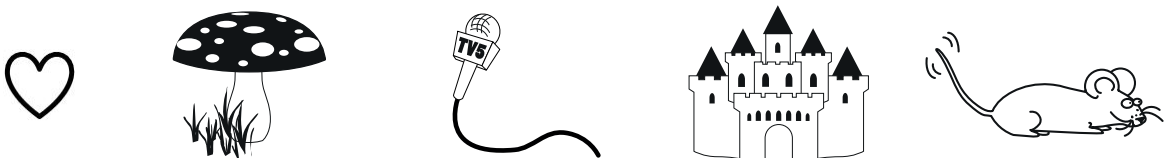
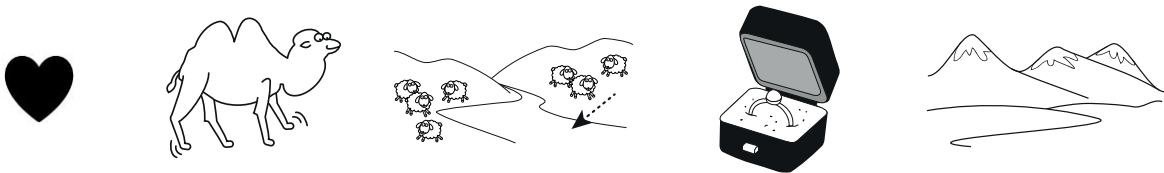
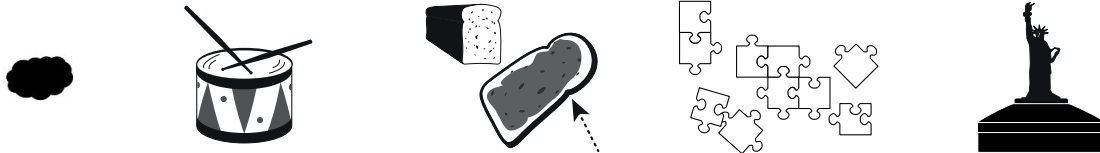

## Exercise 4

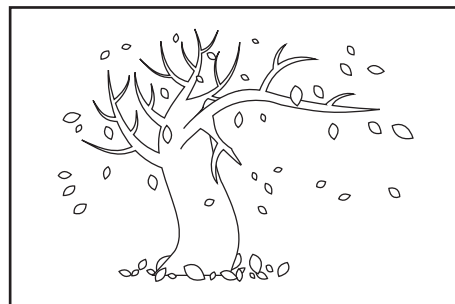
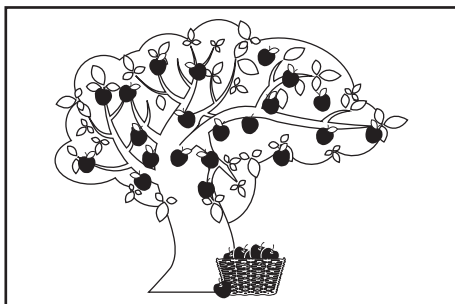
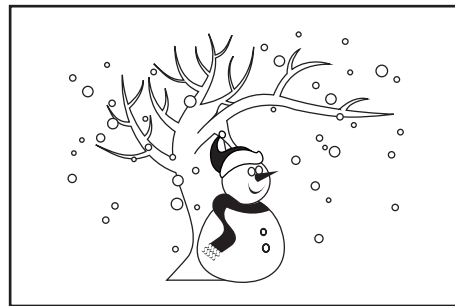
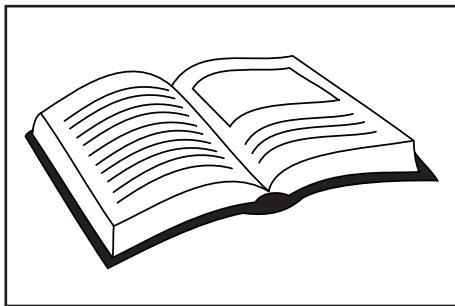
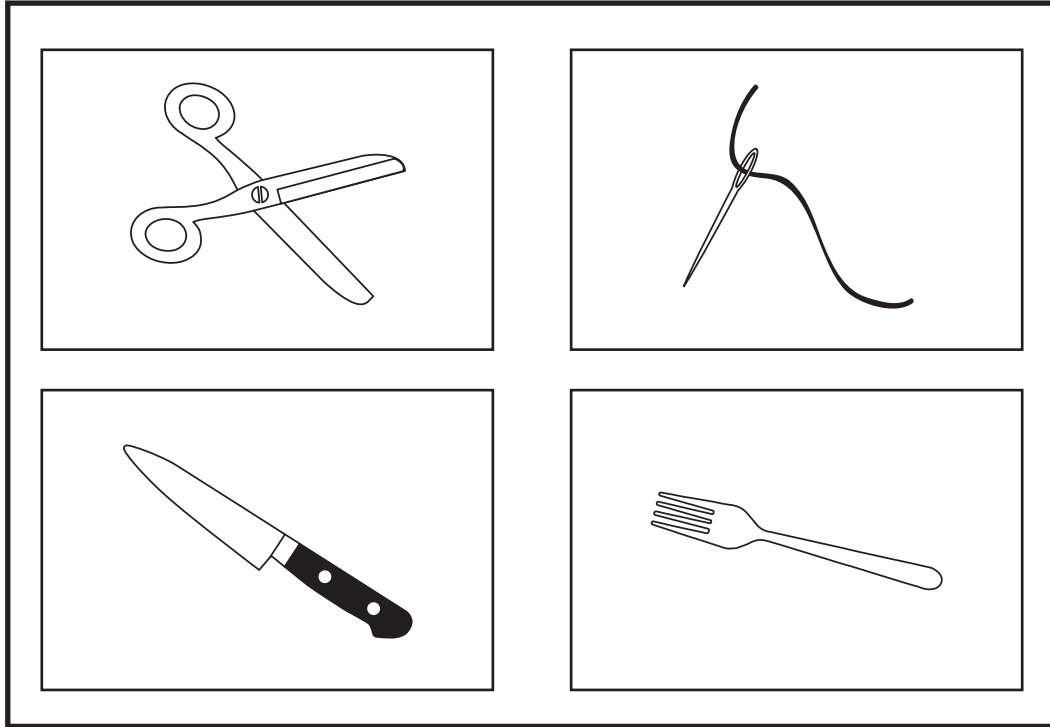

## Exercice 4 (suite)

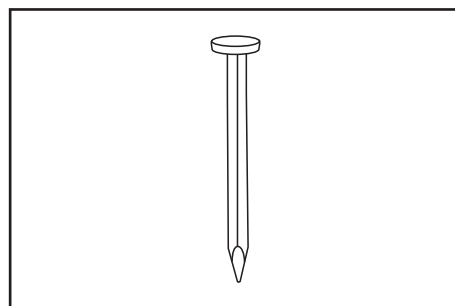
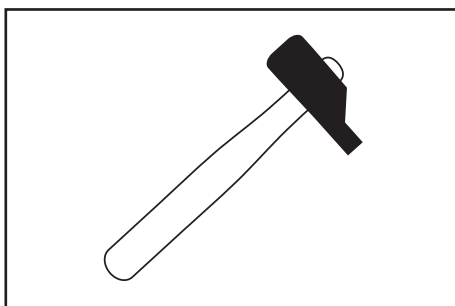
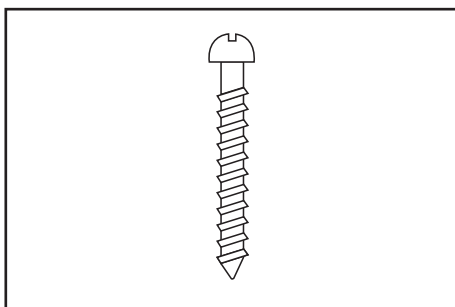
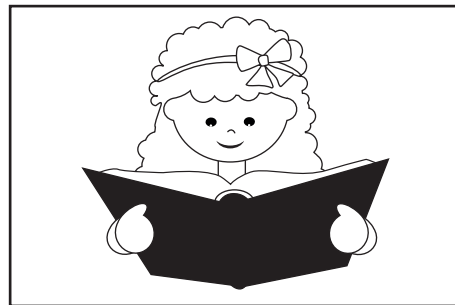
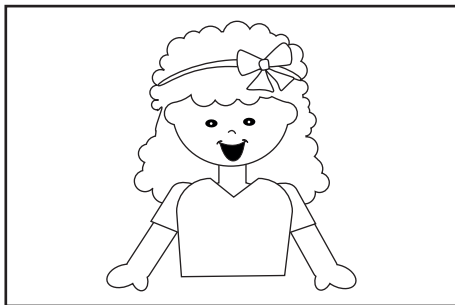
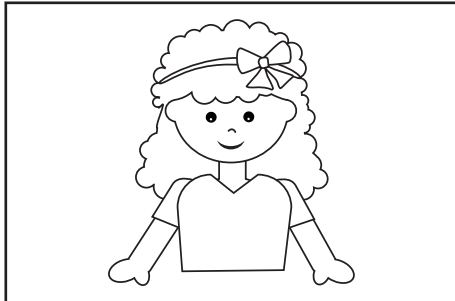

## Exercice 4 (suite)

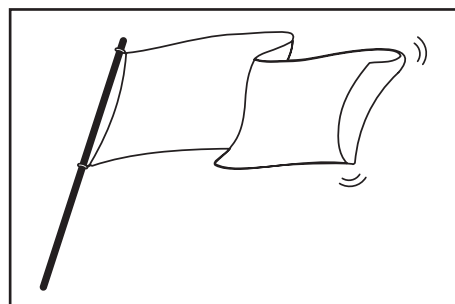
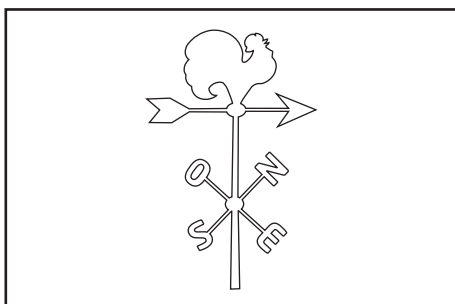
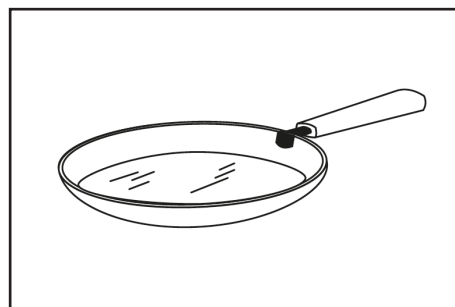
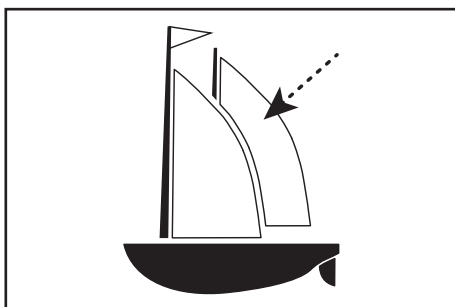
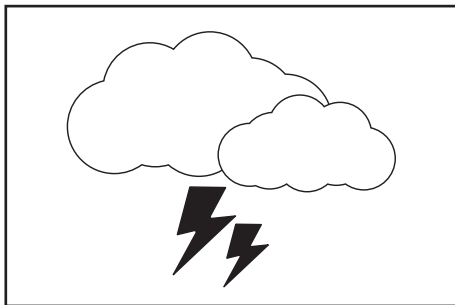
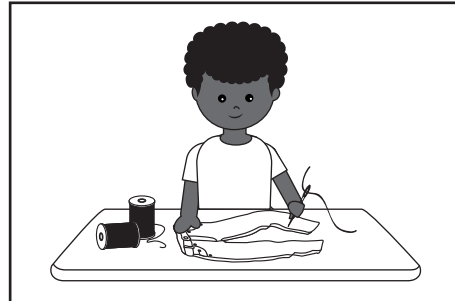
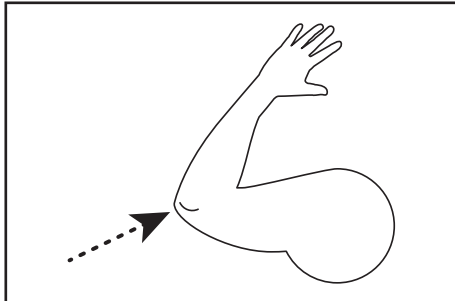

## Exercice 4 (suite)

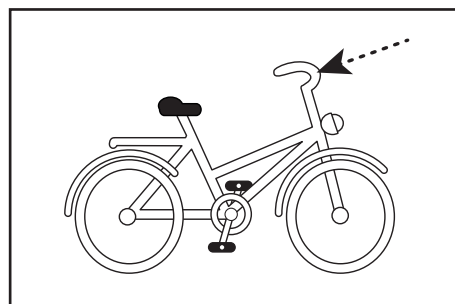
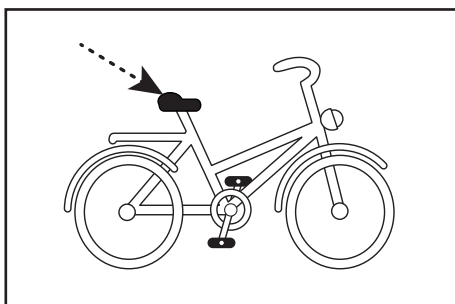
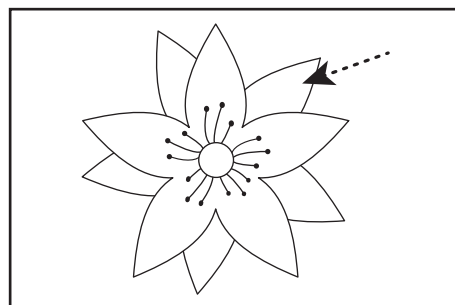
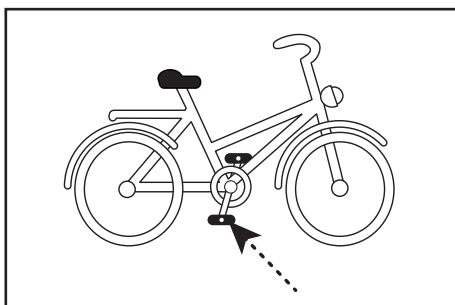
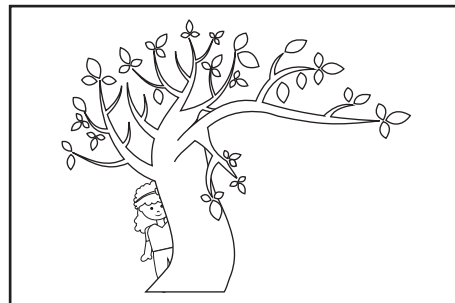
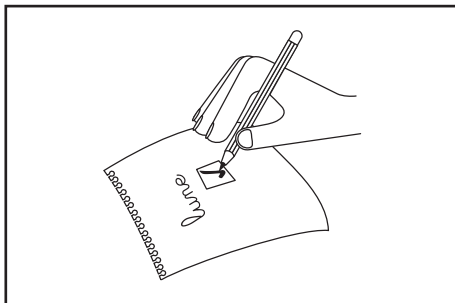
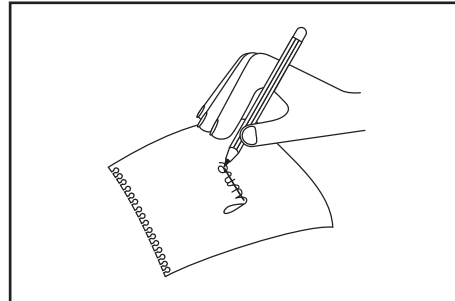
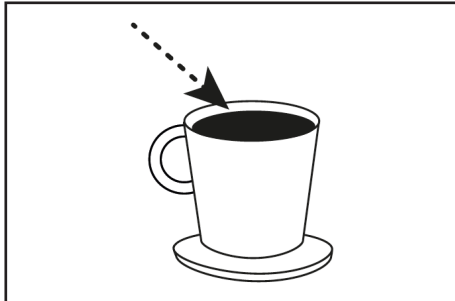

## Exercice 4 (suite)

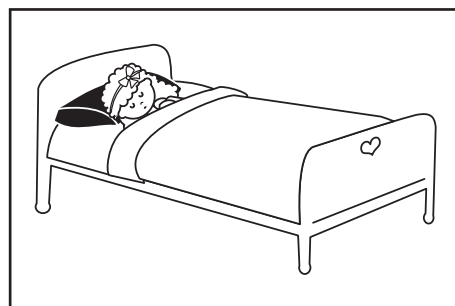
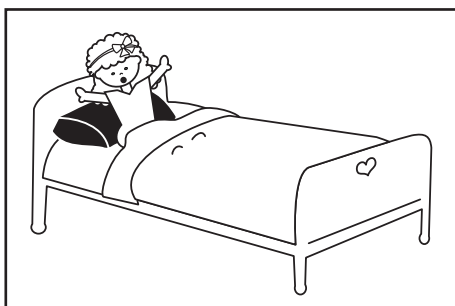
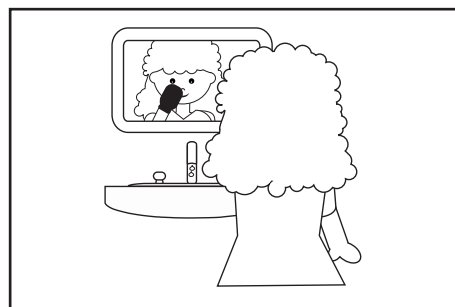
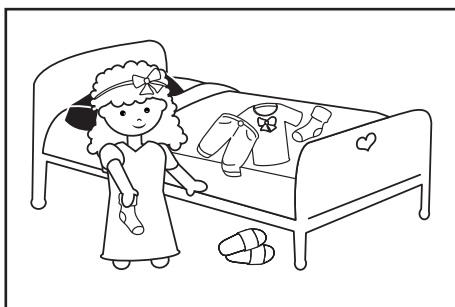
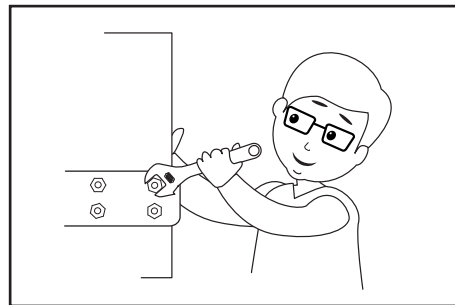
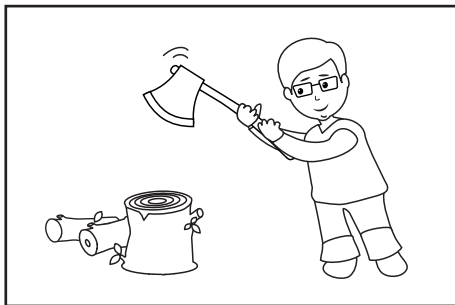
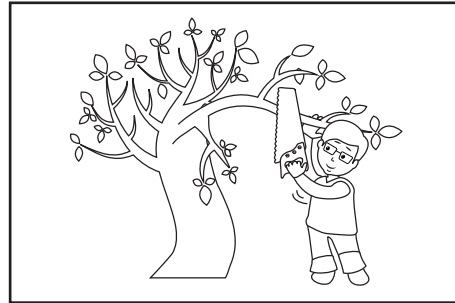
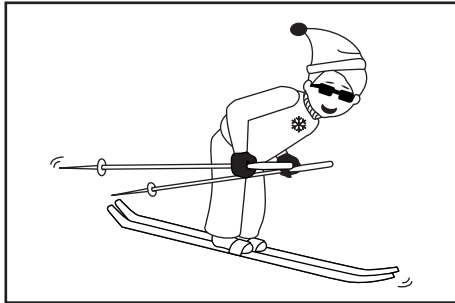



## Exercice 4 (suite)

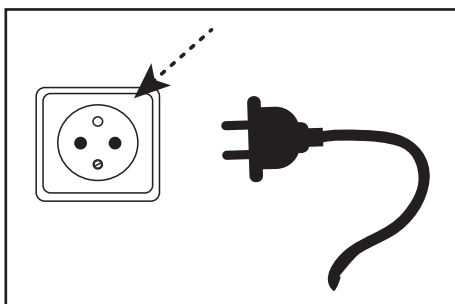
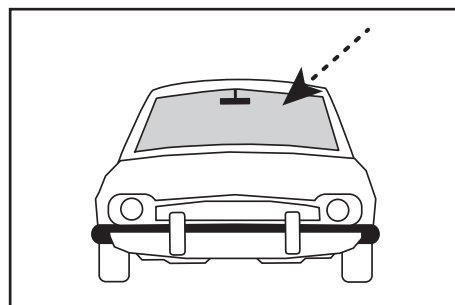
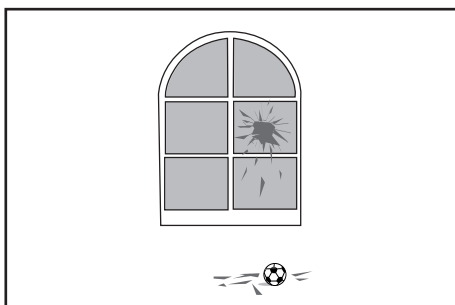
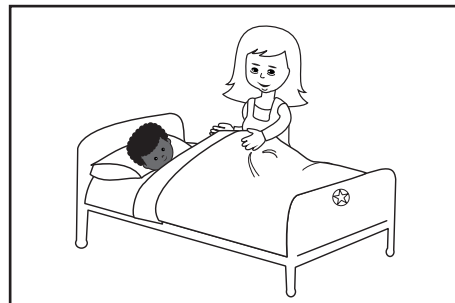
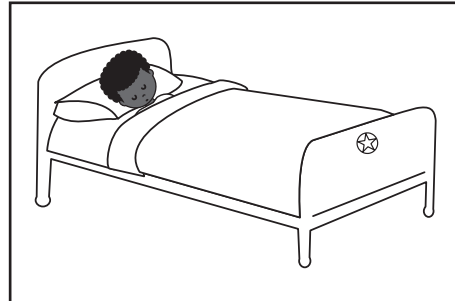
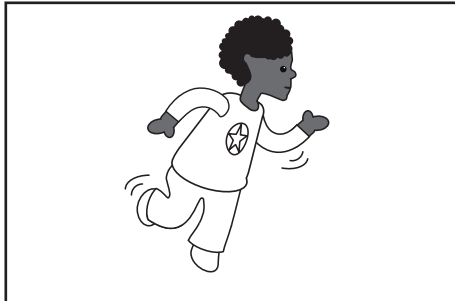

## Exercice 4 (suite)

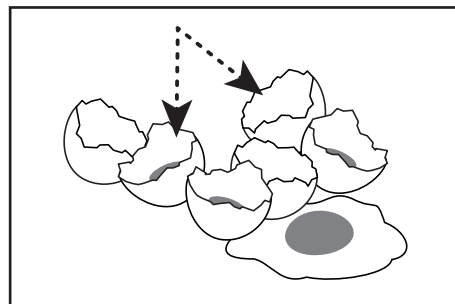
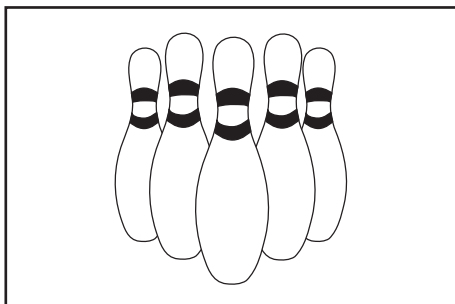
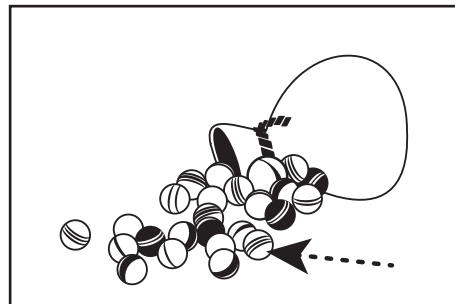
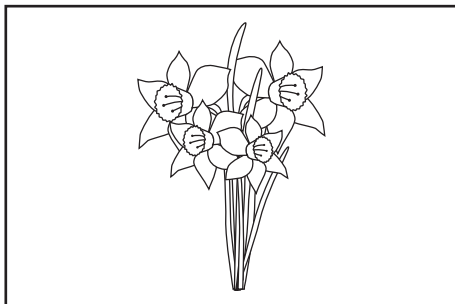
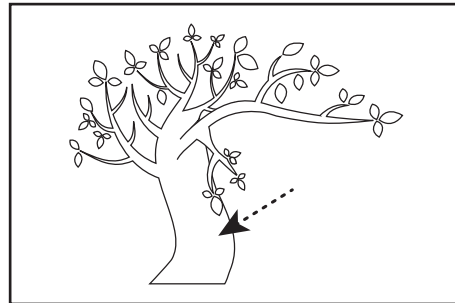
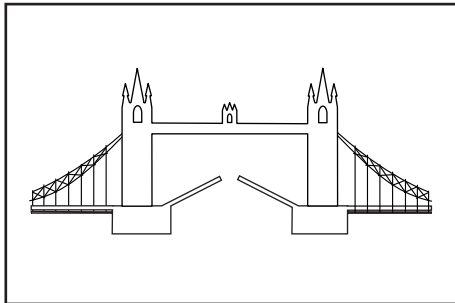
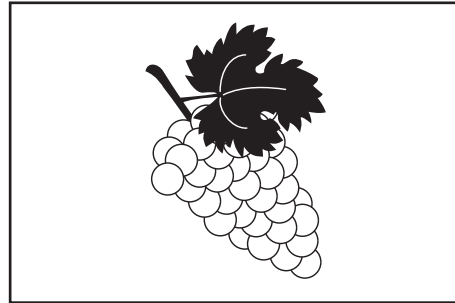
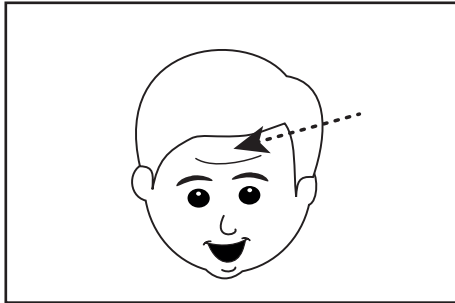

## Exercice 4 (suite)

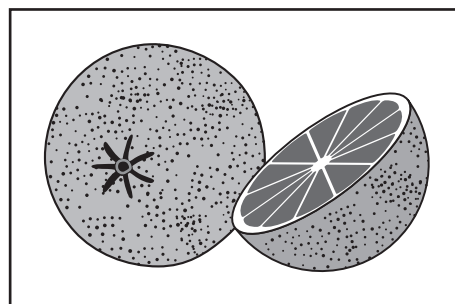
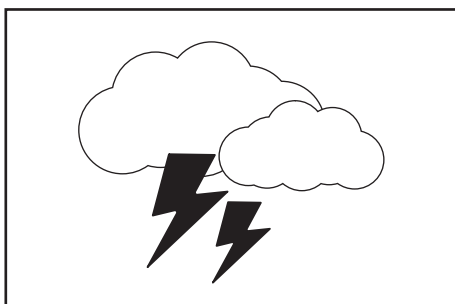
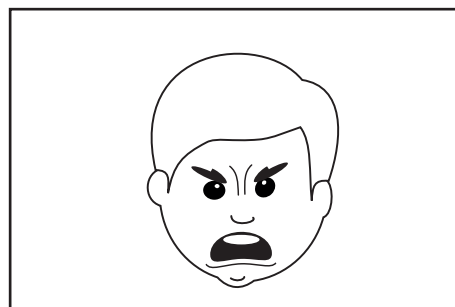
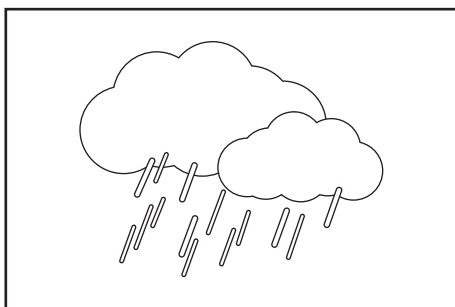
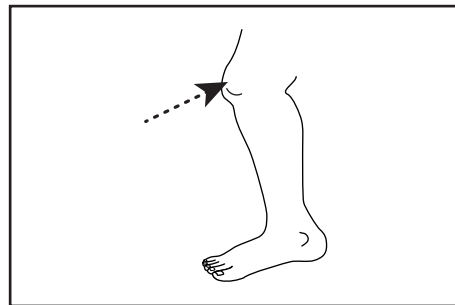
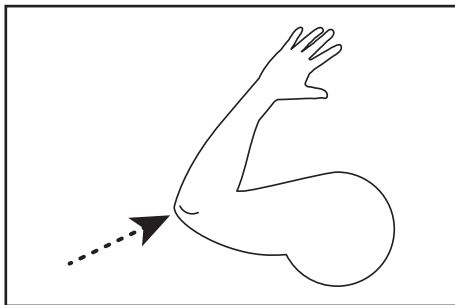
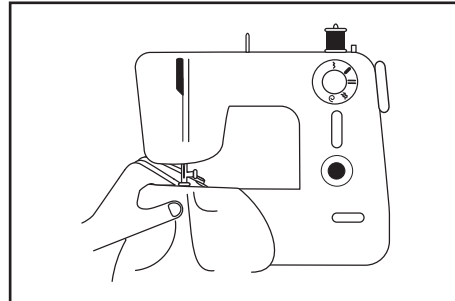
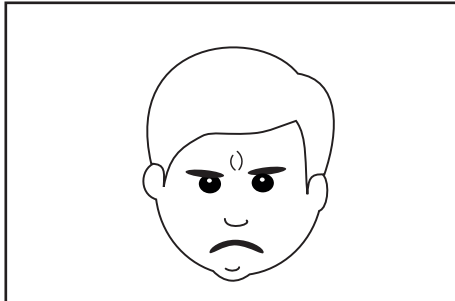



# **SÉQUENCE 2**

---

# **MATHÉMATIQUES**

## Exercise 5

<input checked="" type="radio"/>	2	10	7	1	9	6
----------------------------------	---	----	---	---	---	---

<input type="radio"/>	0	6	3	2	5	1
-----------------------	---	---	---	---	---	---

<input type="checkbox"/>	7	4	1	3	5	2
--------------------------	---	---	---	---	---	---

<input type="checkbox"/>	2	8	6	0	10	9
--------------------------	---	---	---	---	----	---

<input type="checkbox"/>	1	10	0	6	8	2
--------------------------	---	----	---	---	---	---

<input type="checkbox"/>	7	1	2	10	5	3
--------------------------	---	---	---	----	---	---

## Exercice 5 (suite)

---

☛ 0 2 9 10 1 7

☁ 0 6 3 2 5 1

♥ 7 4 1 3 5 2

♡ 2 8 6 0 10 9

✖ 0 2 9 10 1 7

## Exercise 6

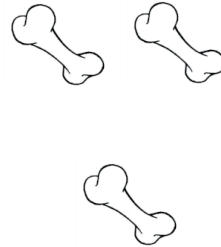
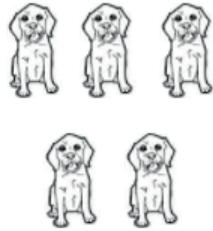

1

2

3

4



5

6



## Exercice 6 (suite)

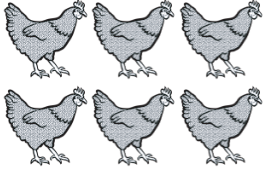

	
---	---

1

2



3

4

5

6

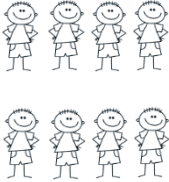

	
---	---

1

2

3

4

5

6

## Exercice 6 (suite)

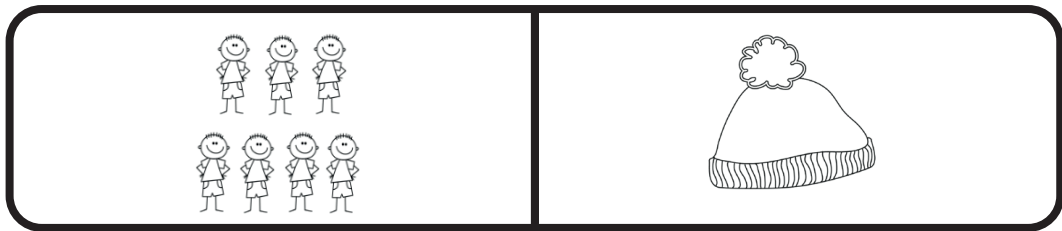

1

2

3

4

5

6

## Exercise 7

---

●



1 2 3 4 5 6 7 8 9 10

○



1 2 3 4 5 6 7 8 9 10

➔



1 2 3 4 5 6 7 8 9 10

## Exercice 7 (suite)



1	2	3	4	5	6	7	8	9	10
---	---	---	---	---	---	---	---	---	----



1	2	3	4	5	6	7	8	9	10
---	---	---	---	---	---	---	---	---	----



1	2	3	4	5	6	7	8	9	10
---	---	---	---	---	---	---	---	---	----

## Exercice 7 (suite)



1	2	3	4	5	6	7	8	9	10
---	---	---	---	---	---	---	---	---	----



1	2	3	4	5	6	7	8	9	10
---	---	---	---	---	---	---	---	---	----



1	2	3	4	5	6	7	8	9	10
---	---	---	---	---	---	---	---	---	----

## Exercise 8

---

Exemples

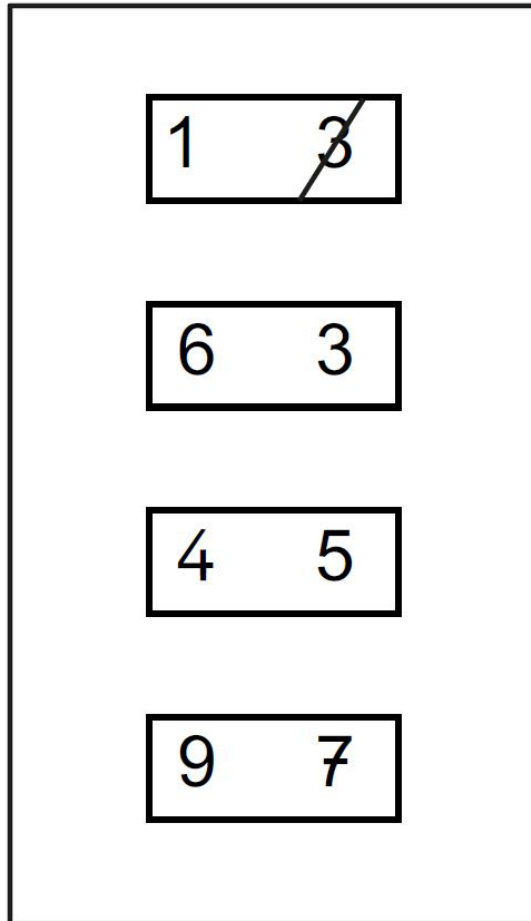

## Exercice 8 (suite)

8	9	7	4	5	6	4	1
2	6	5	9	4	3	9	6
5	4	7	6	2	1	5	8
3	2	5	1	9	8	3	4
4	1	8	9	4	5	2	6
2	5	1	4	8	7	5	1
3	6	8	5	2	3	9	8
8	4	1	2	6	7	5	4
6	7	4	3	9	5	1	2
2	1	5	6	4	8	7	6

## Exercise 9

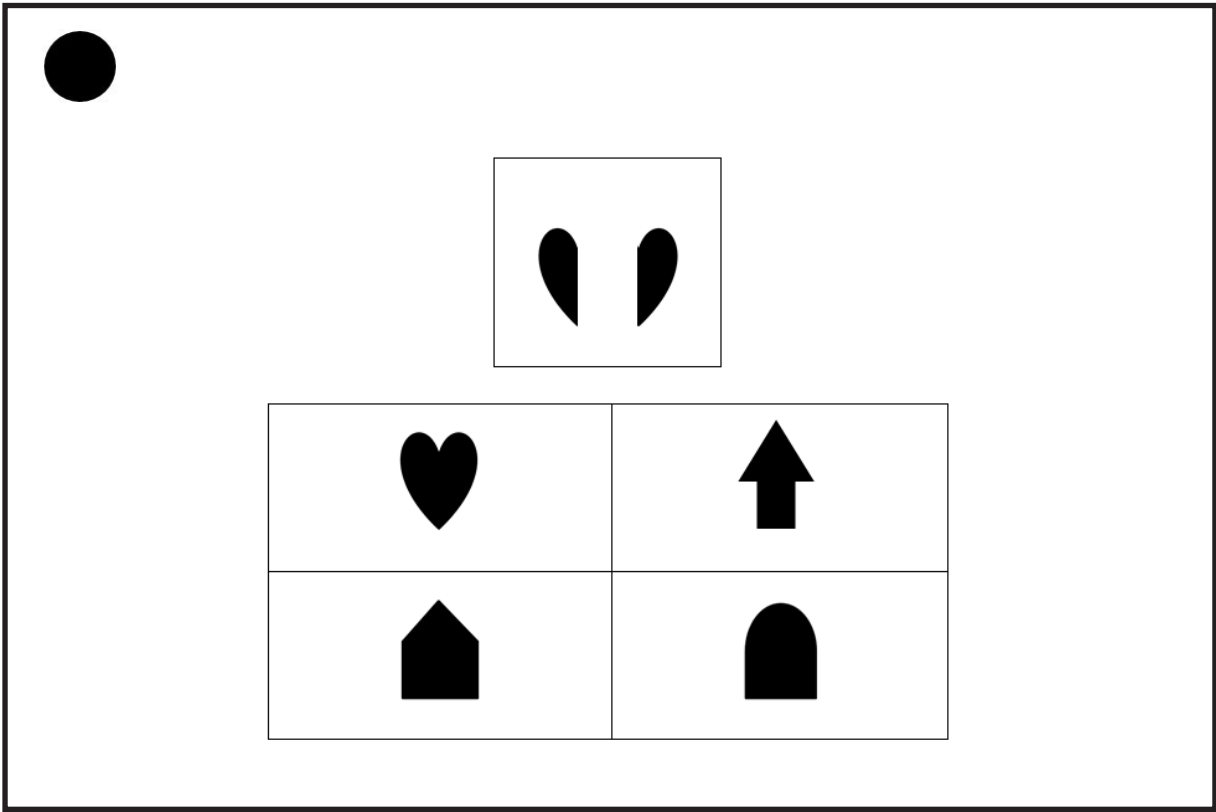



## Exercice 9 (suite)

---

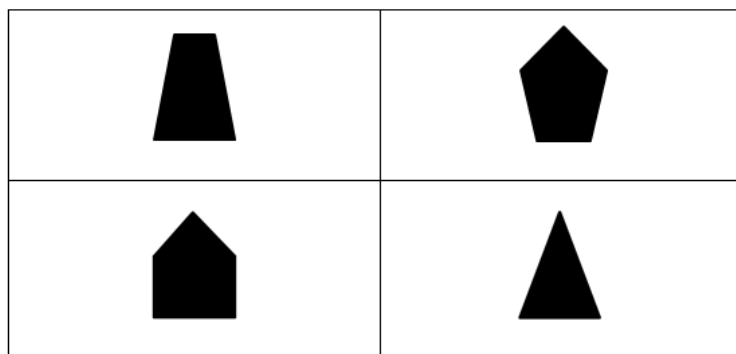
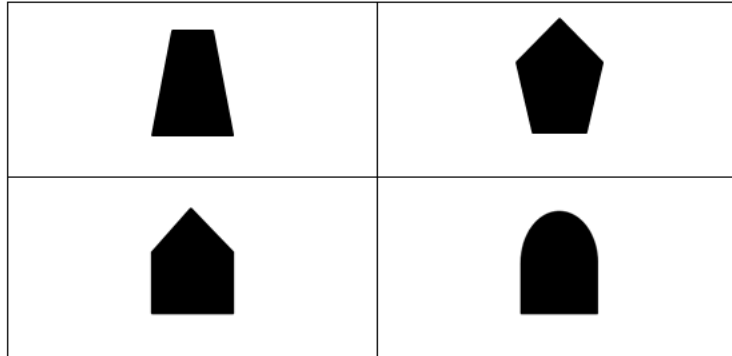
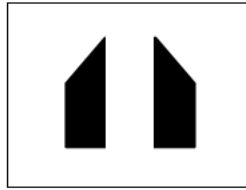

## Exercice 9 (suite)

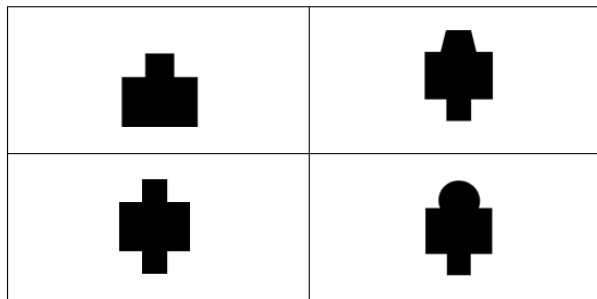
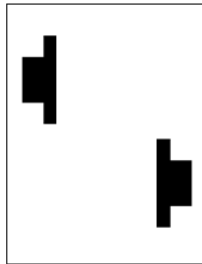
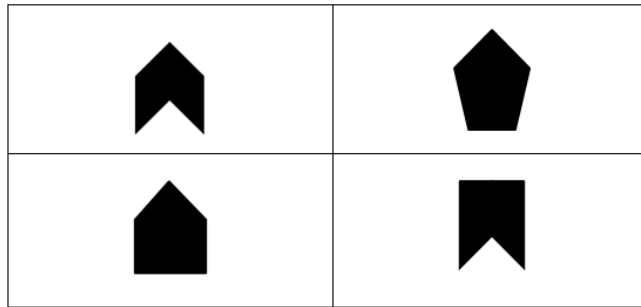
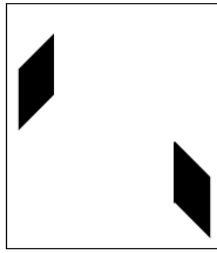

## Exercice 9 (suite)

---

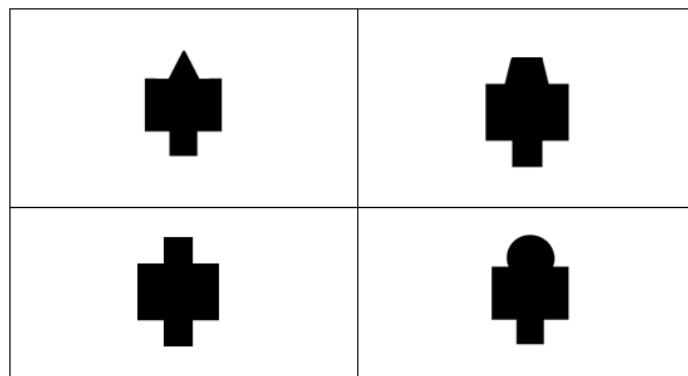
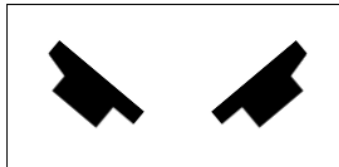
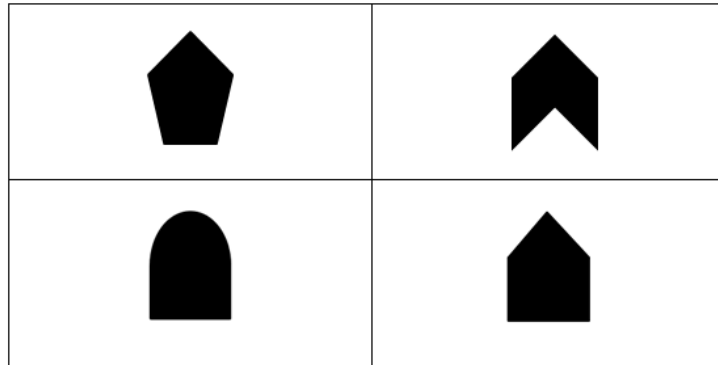
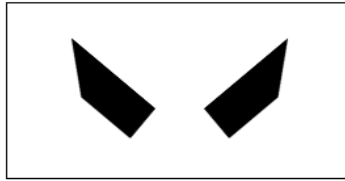

## Exercice 9 (suite)

---

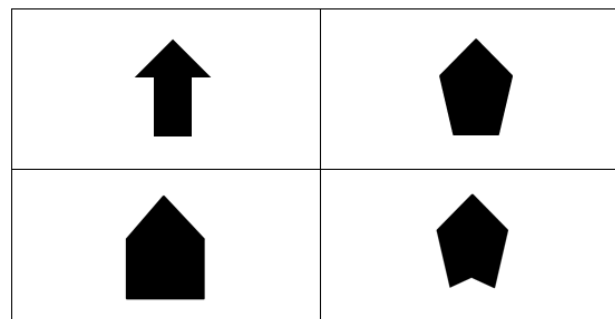
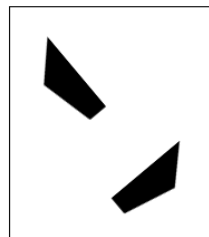
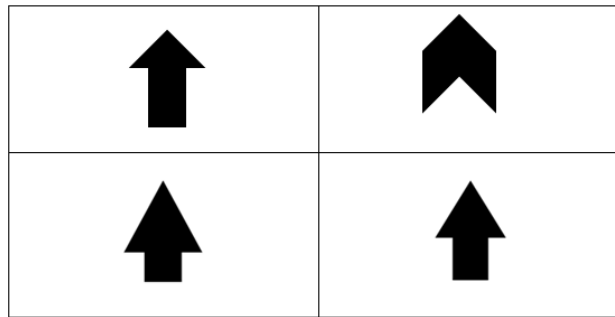
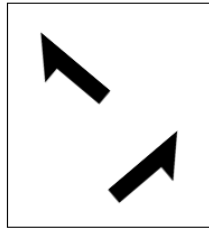

# **SÉQUENCE 3**

---

## **FRANÇAIS**

## Exercise 10

---

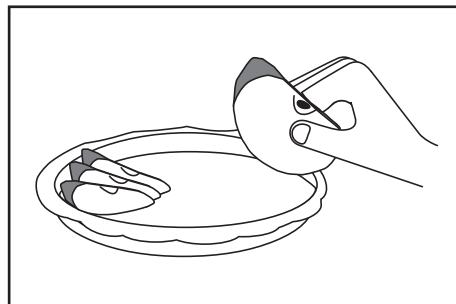
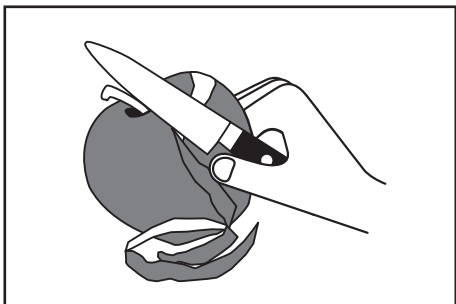
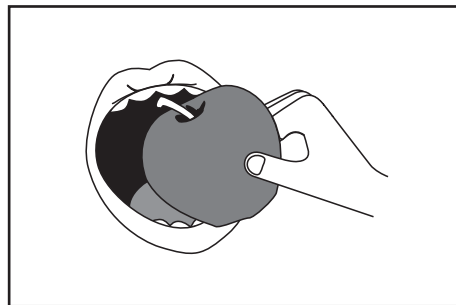
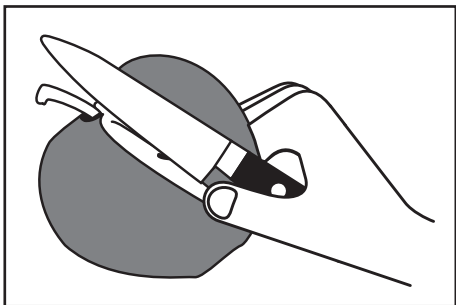
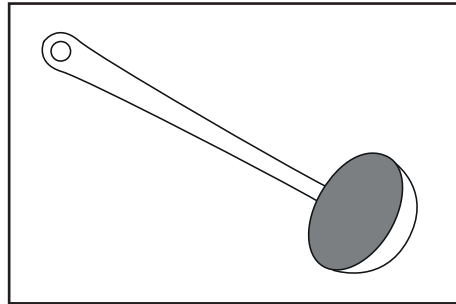
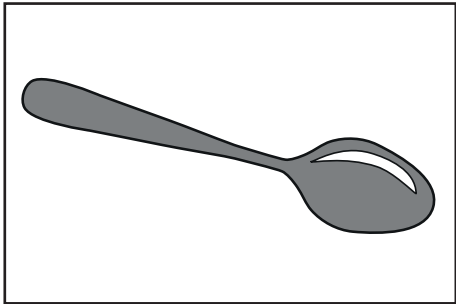
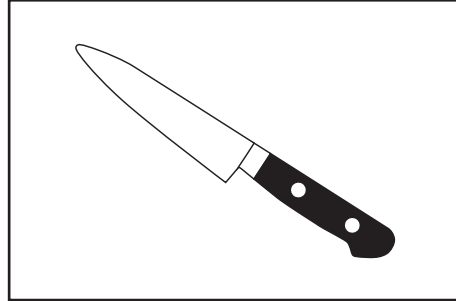
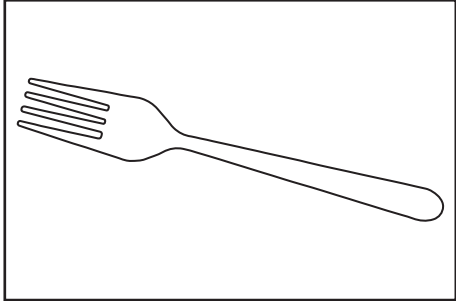

## Exercice 10 (suite)

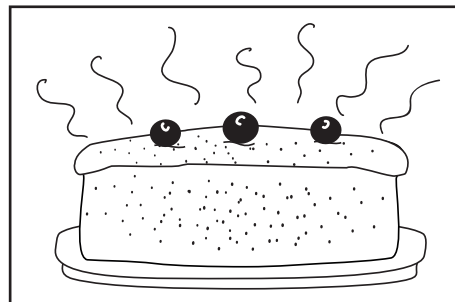
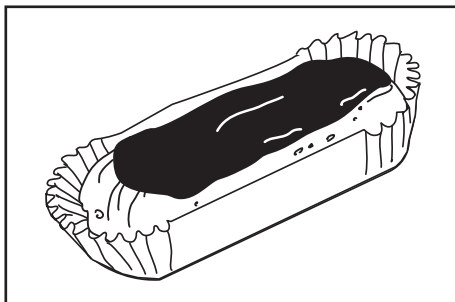
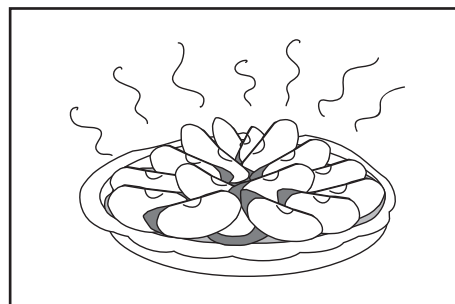
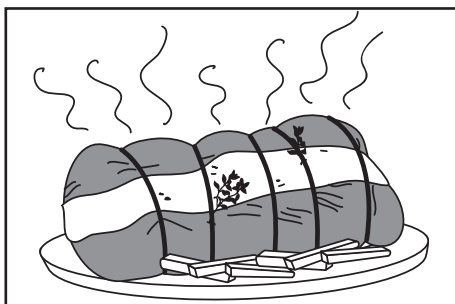
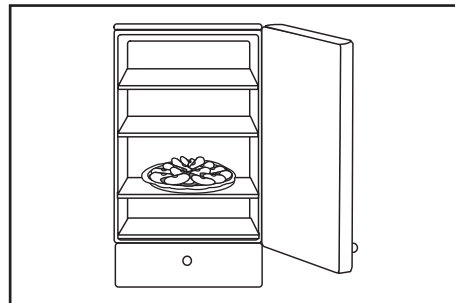
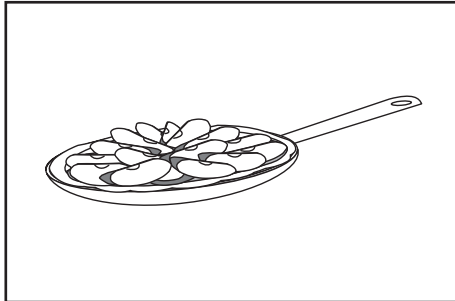

# Exercise 11

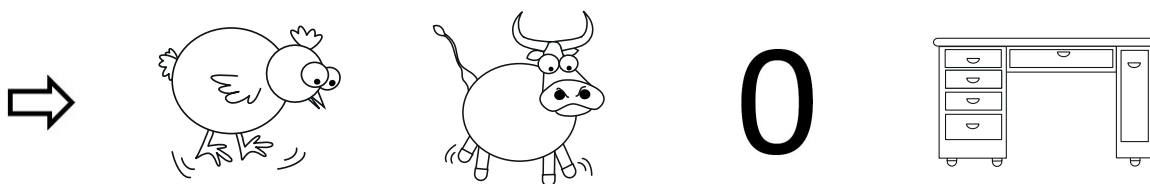
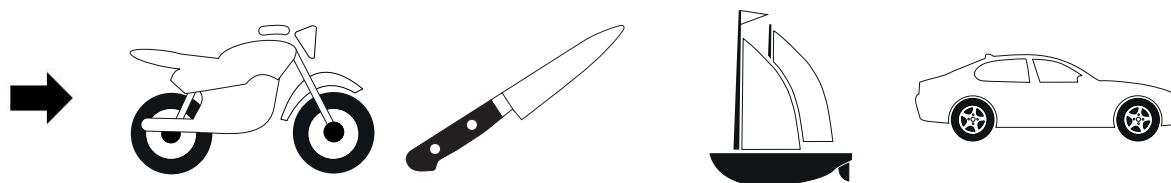
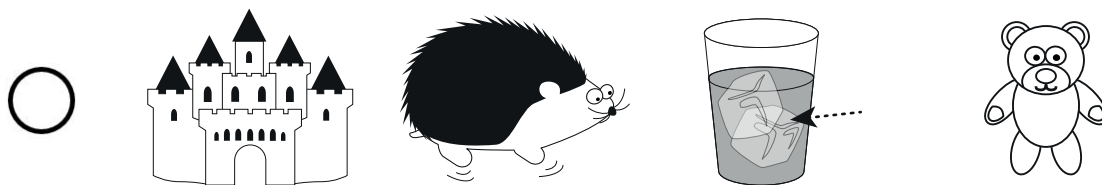
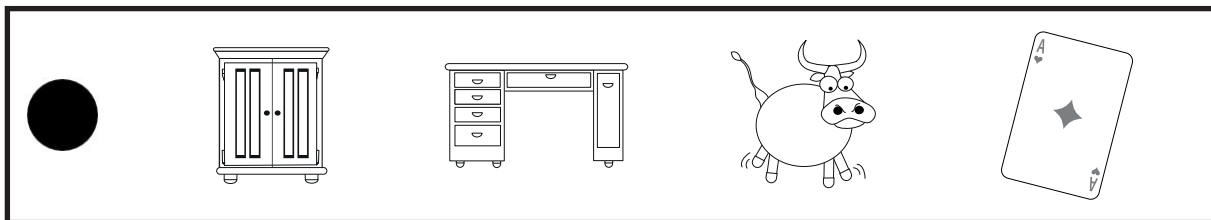



## Exercice 11 (suite)

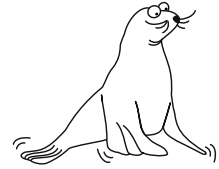
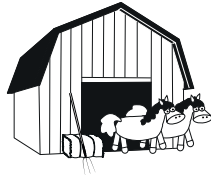
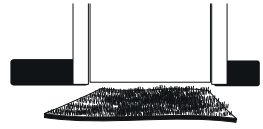
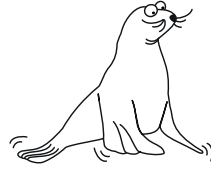
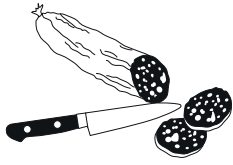

## Exercise 12

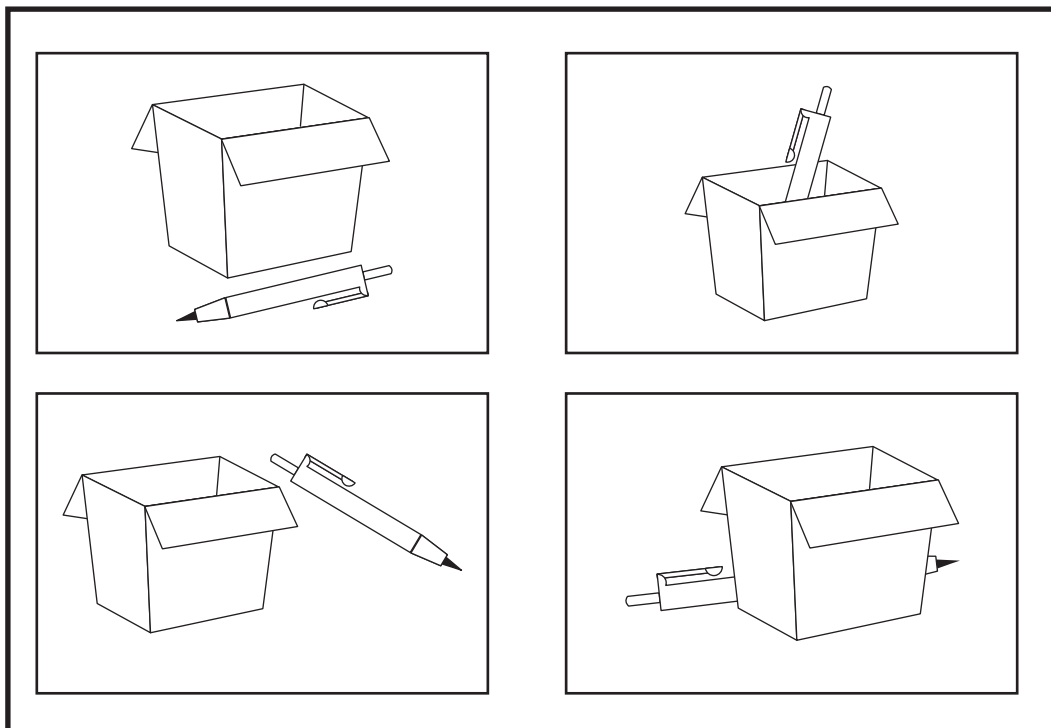
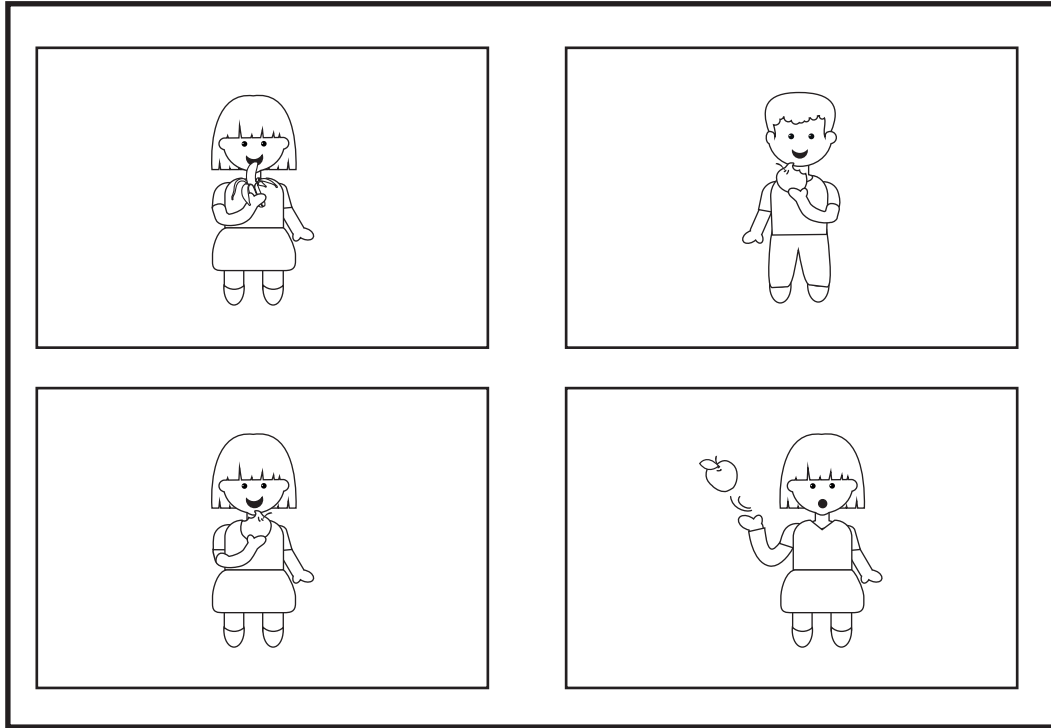

## Exercice 12 (suite)

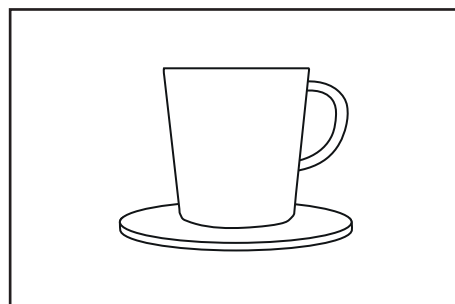
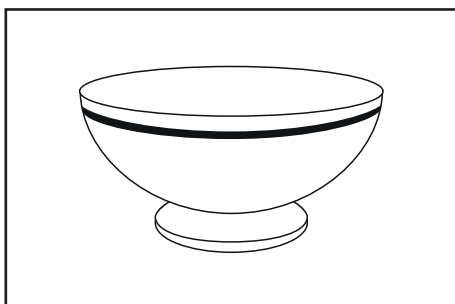
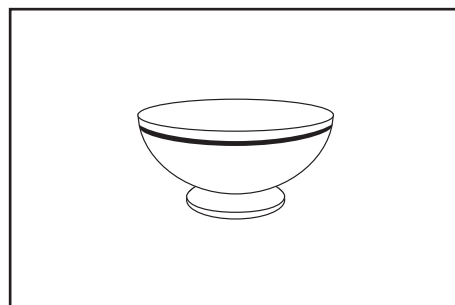
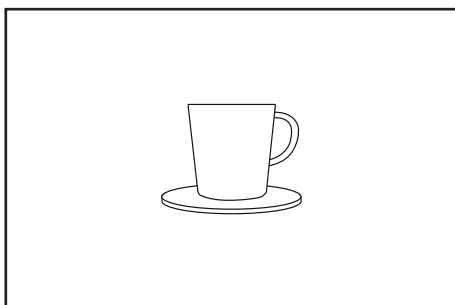
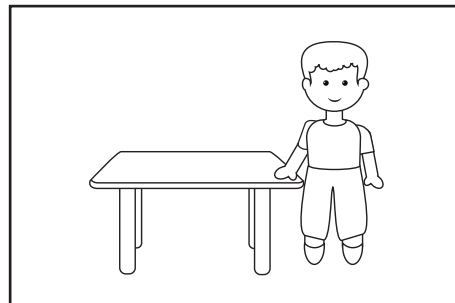
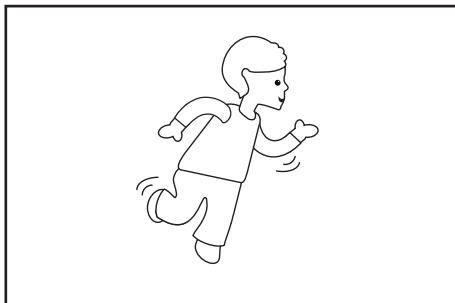
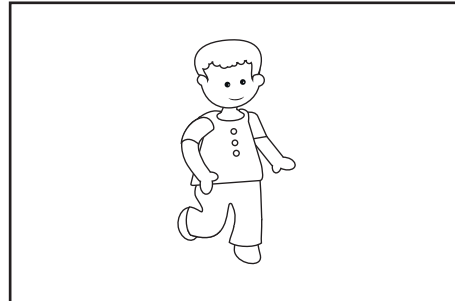
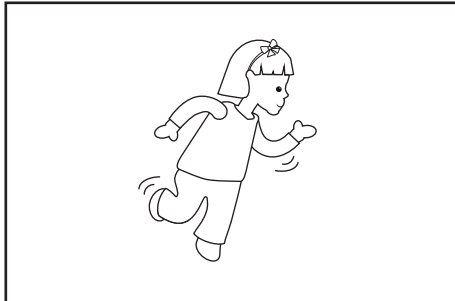

## Exercice 12 (suite)

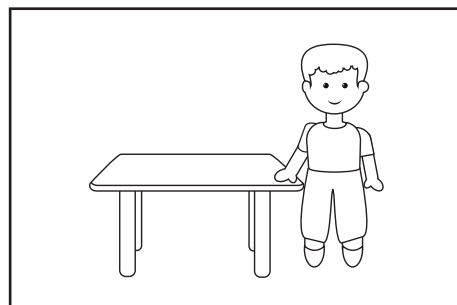
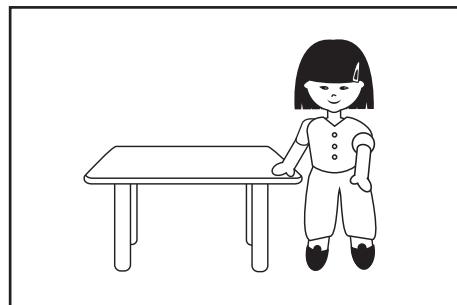
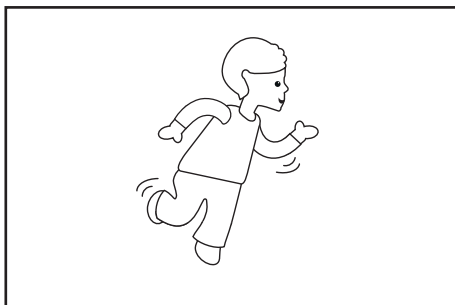
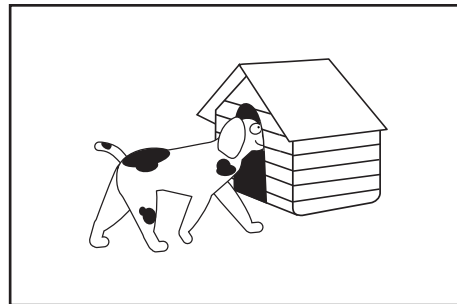
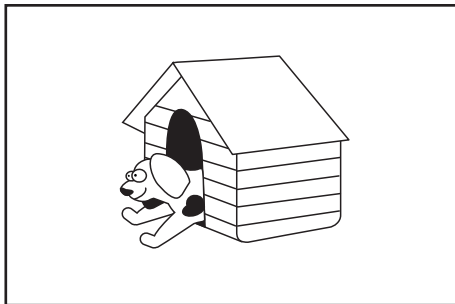
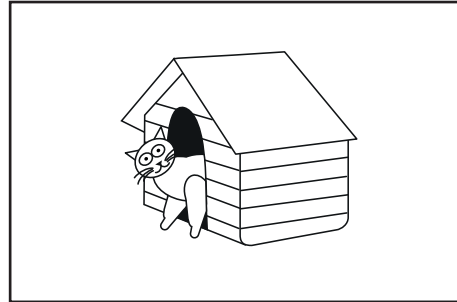
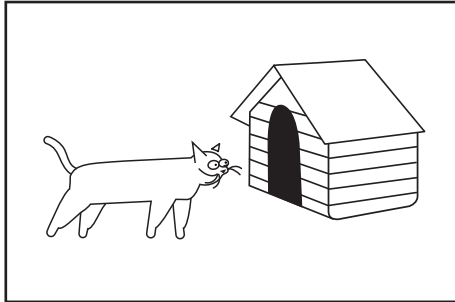

## Exercice 12 (suite)

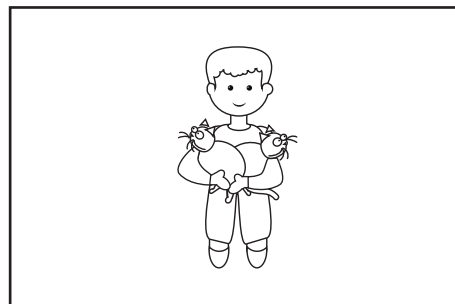
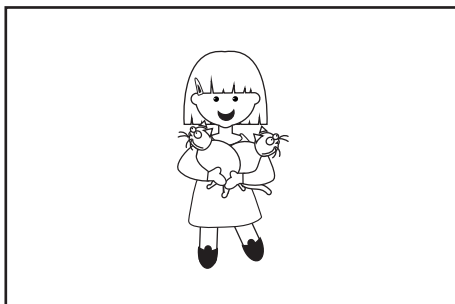
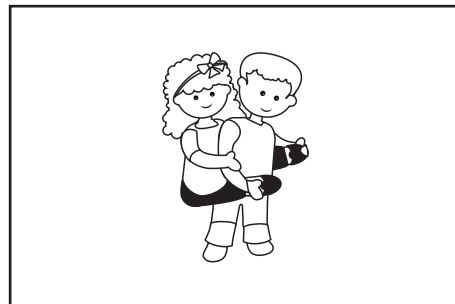
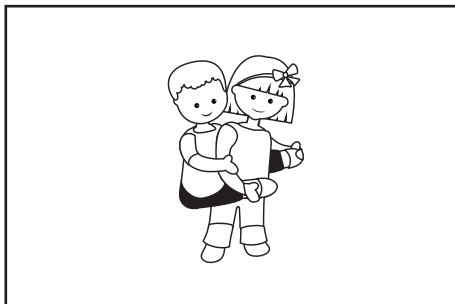
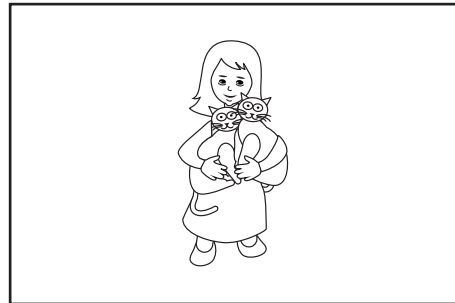
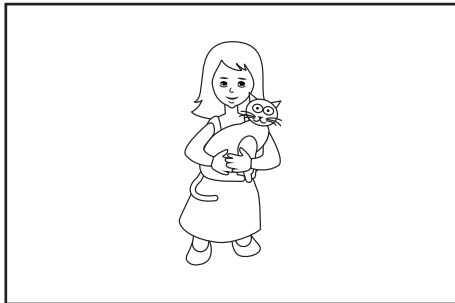
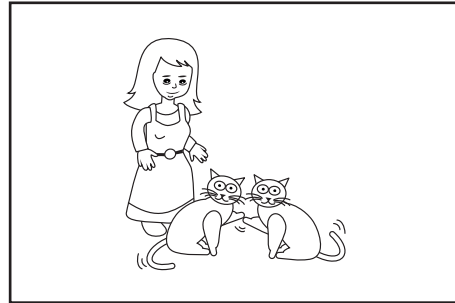
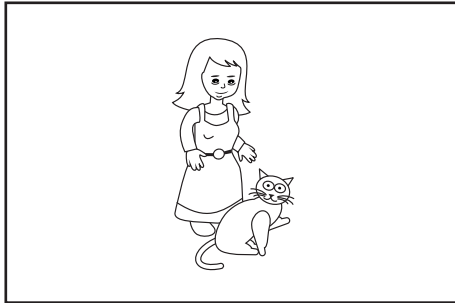

## Exercice 12 (suite)

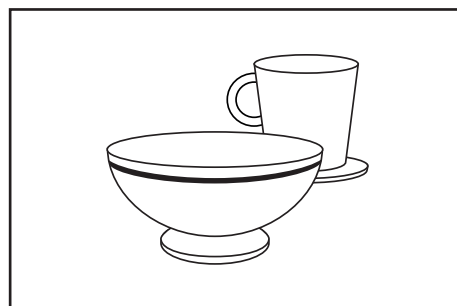
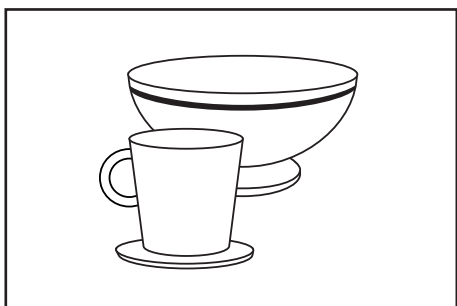
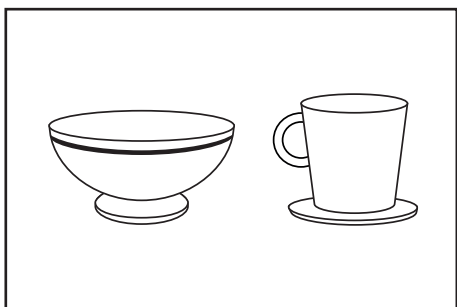
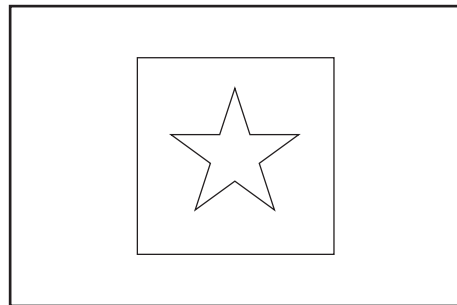
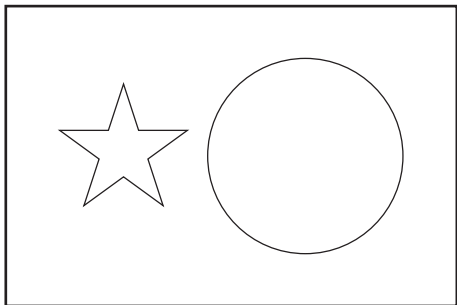
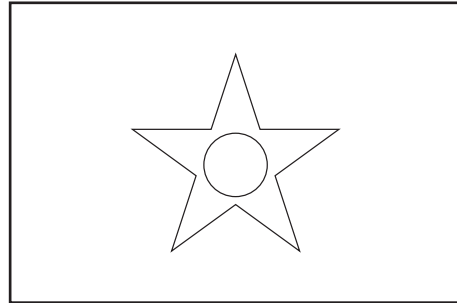
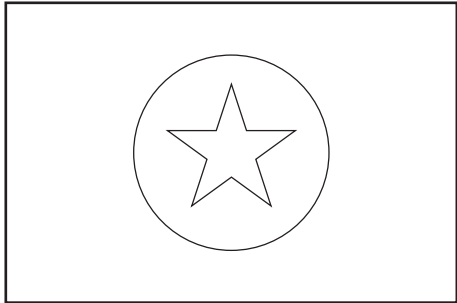

## Exercice 12 (suite)

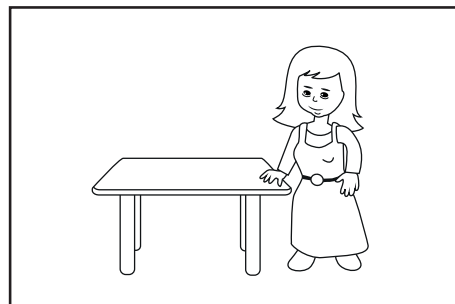
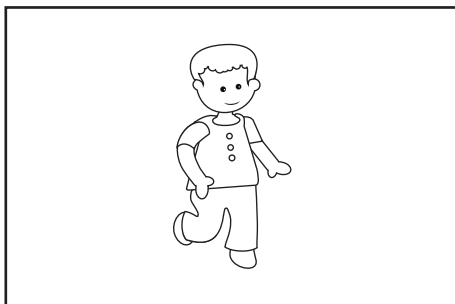
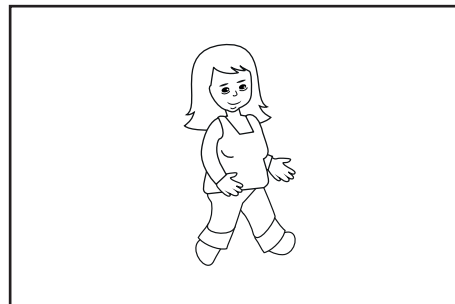
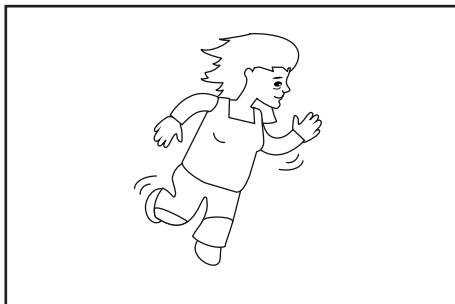
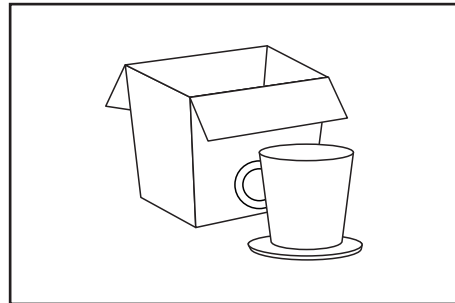
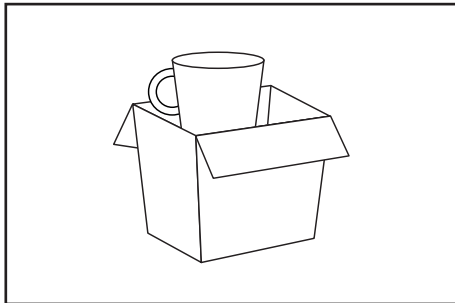
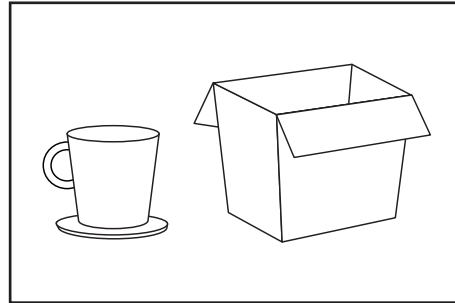
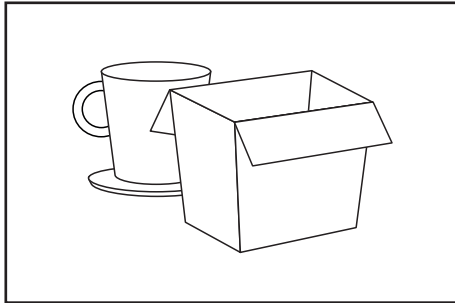

## Exercice 12 (suite)

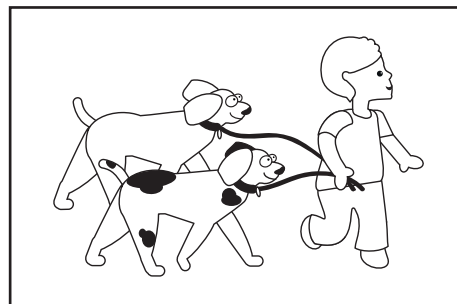
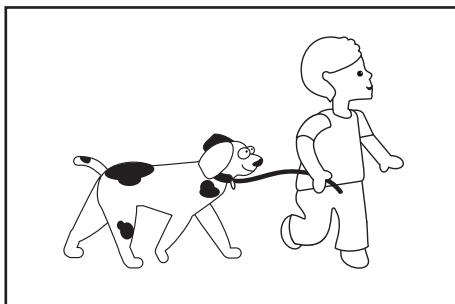
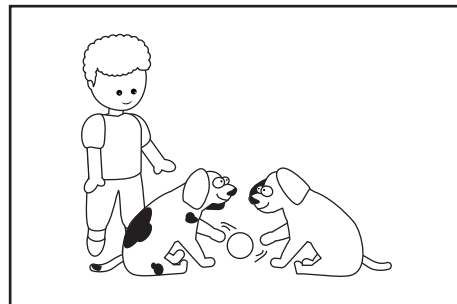
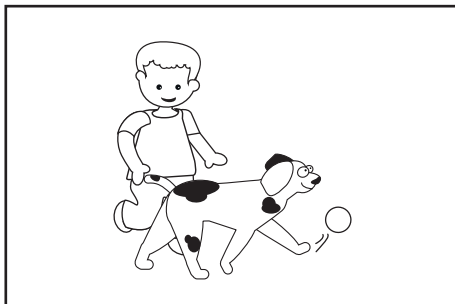
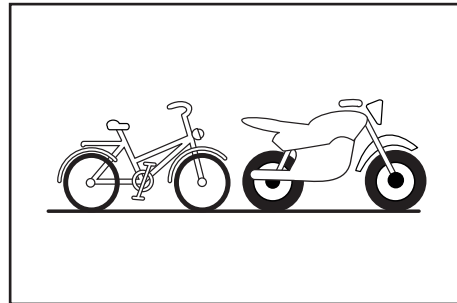
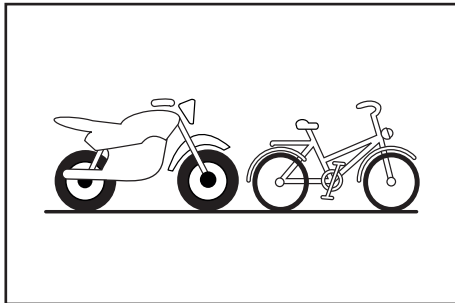
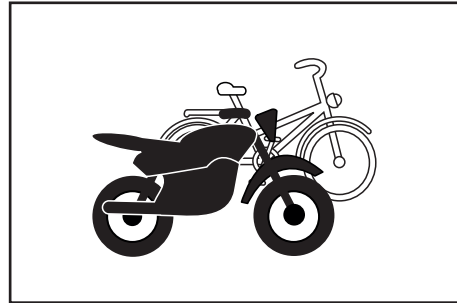
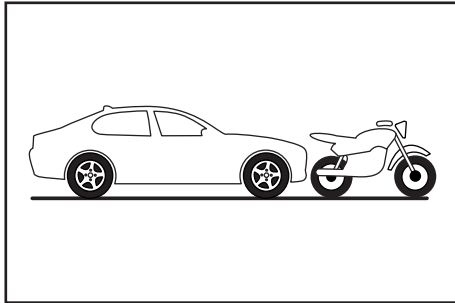



## Exercice 12 (suite)

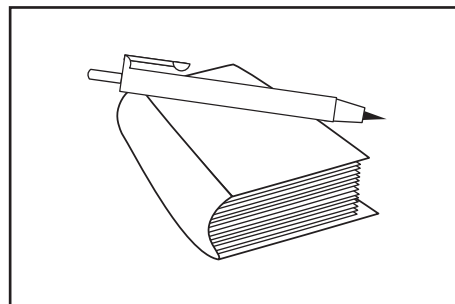
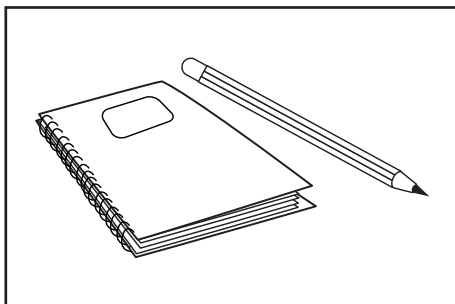
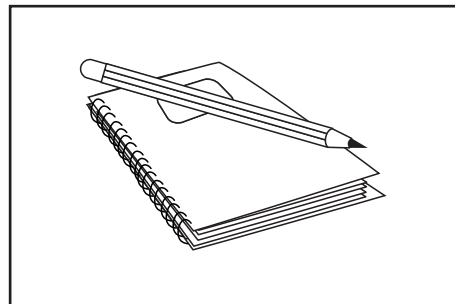
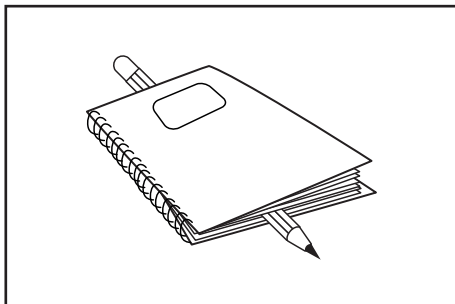
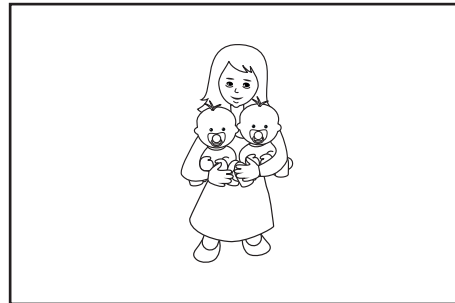
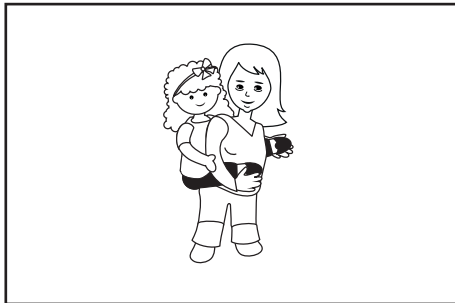
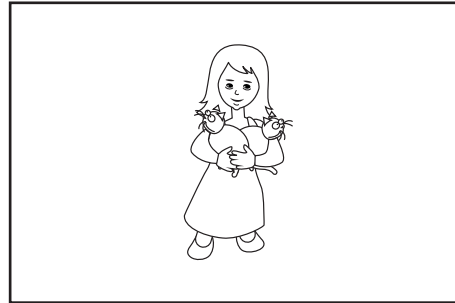
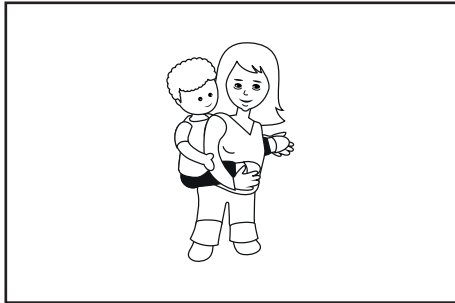



# **SÉQUENCE 4**

---

# **MATHÉMATIQUES**

# Exercise 13

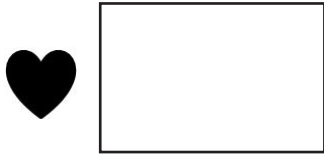
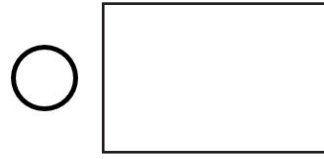
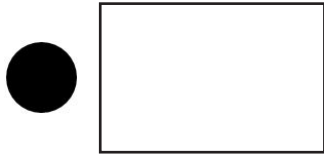

## Exercise 14

---

1      2      3      4      5      6

1      2      3      4      5      6

## Exercice 14 (suite)

---



1      2      3      4      5      6



1      2      3      4      5      6

# Exercise 15

A number line is shown with a scale from 0 to 10. The number 0 is at the left end and 10 is at the right end. There are 10 equal intervals between 0 and 10, each marked with a tick. Above the 0 mark, there is a diamond-shaped box containing an empty diamond. Below the number line, there are six diamond-shaped boxes containing the numbers 4, 8, 6, 5, 2, and 1.

A number line is shown with a scale from 0 to 10. The number 0 is at the left end and 10 is at the right end. There are 10 equal intervals between 0 and 10, each marked with a tick. Above the 10 mark, there is a diamond-shaped box containing an empty diamond. Below the number line, there are six diamond-shaped boxes containing the numbers 3, 1, 8, 9, 5, and 2.

## Exercice 15 (suite)

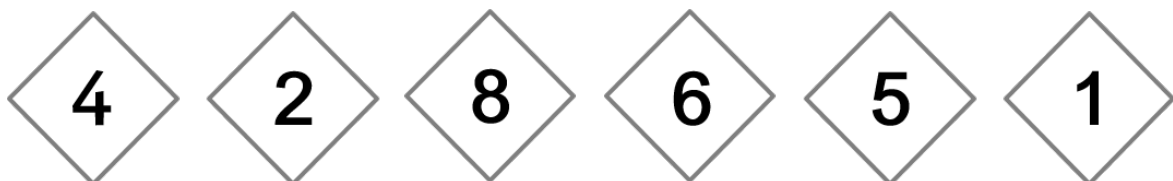
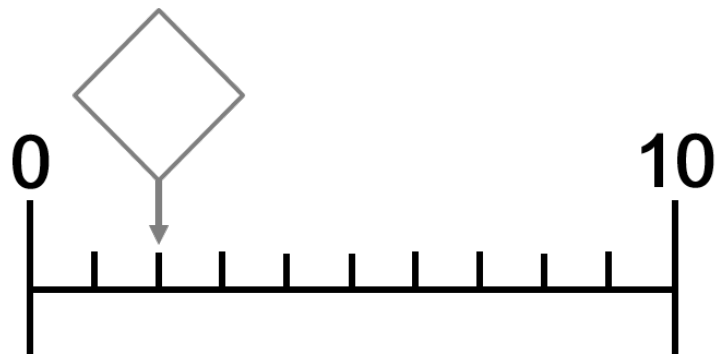
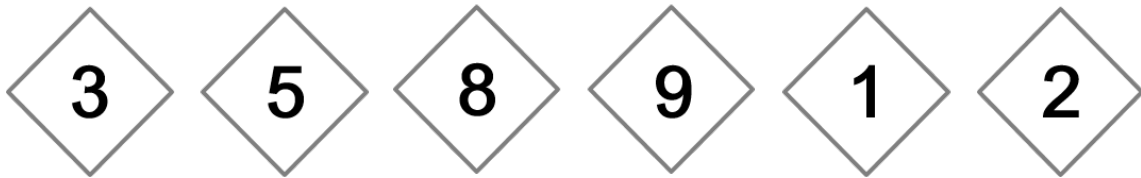
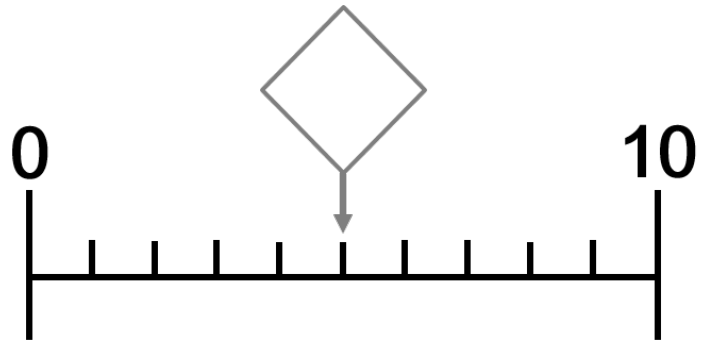



## Exercice 15 (suite)

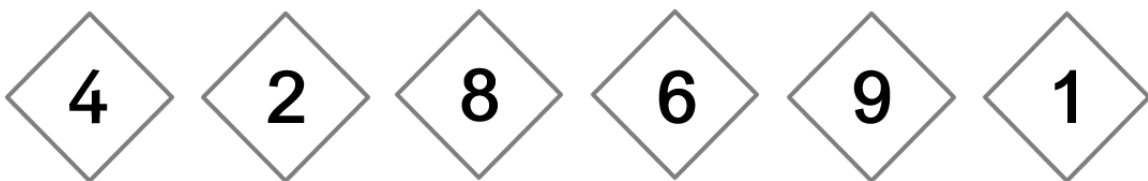
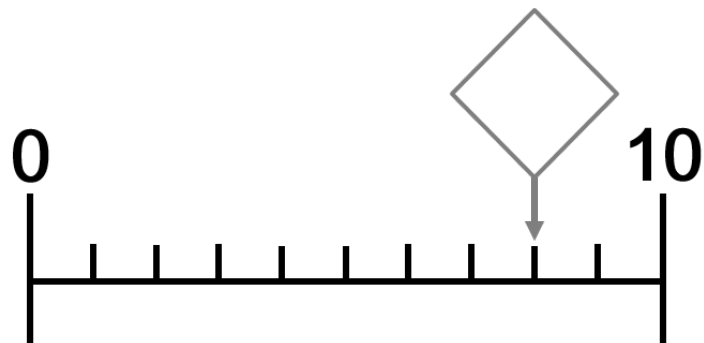
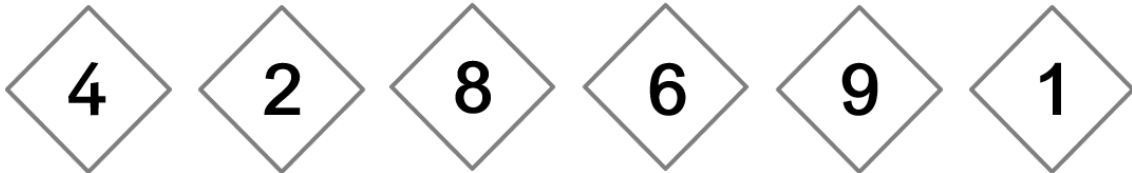
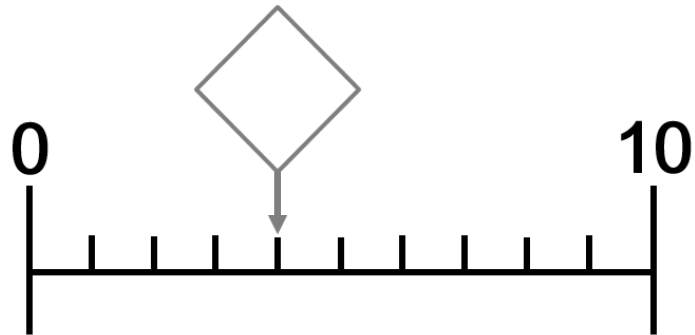

## Exercice 15 (suite)

---

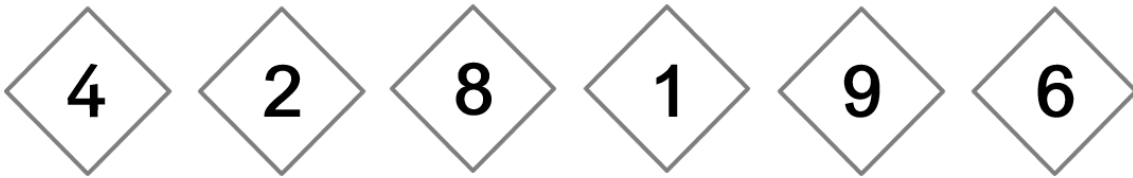
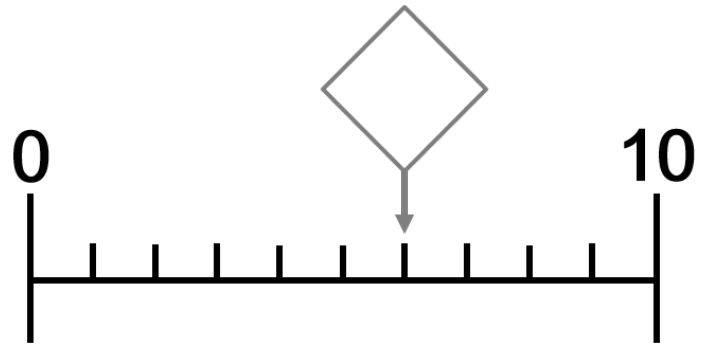

# **SÉQUENCE 5**

---

## **FRANÇAIS**

## Exercise 16

---

● m n b d f

○ s r p t f

---

➔ m s r b d

---

➞ m b d f j

---

■ l t d h f

---

## Exercice 16 (suite)

 m b d f n

---

 h l v b d

---

 n m r t v

---

 n m r t s

---

 n d t s f

---

 n m v u f

---

# Exercise 17

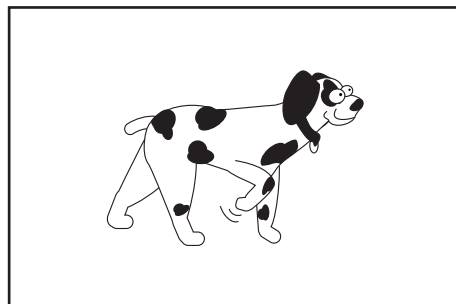
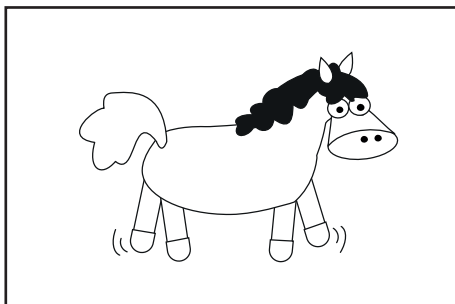
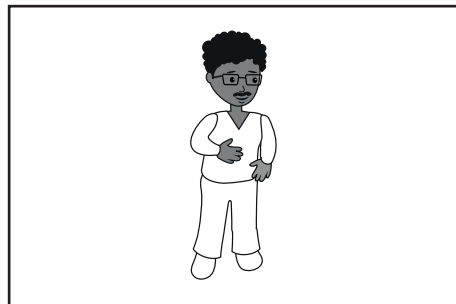
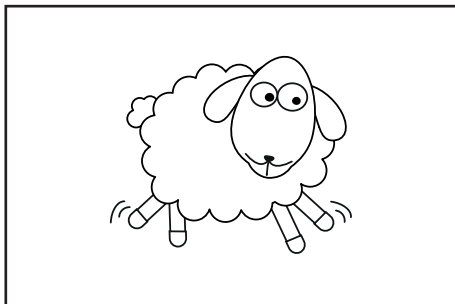
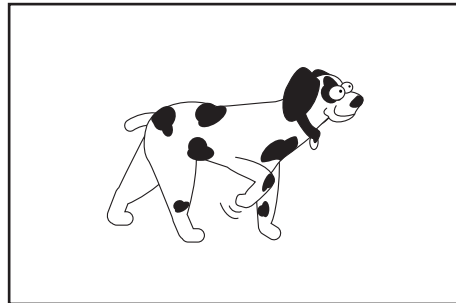
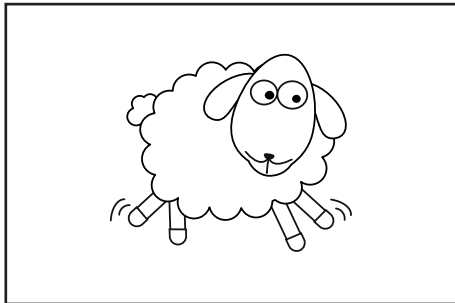
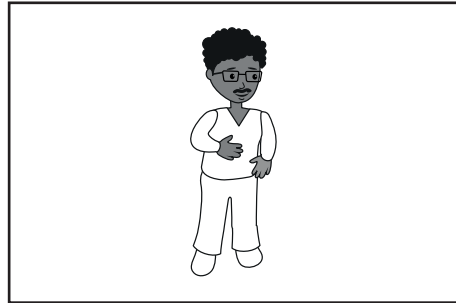
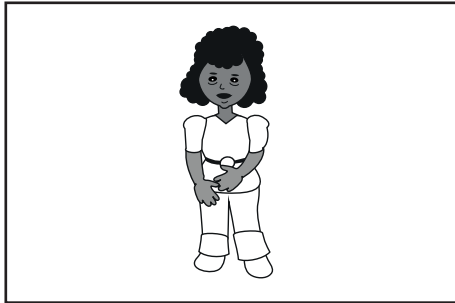

## Exercice 17 (suite)

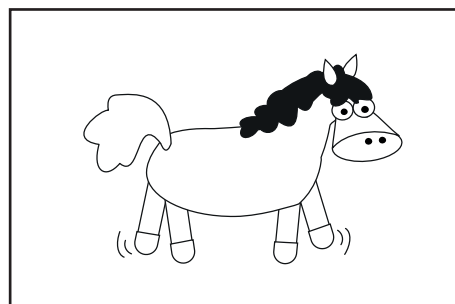
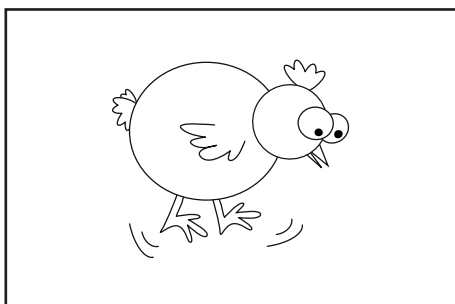
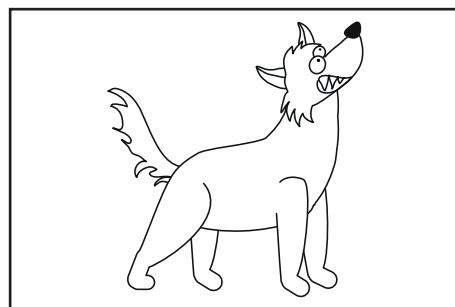
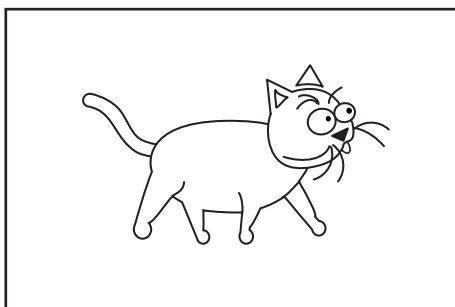
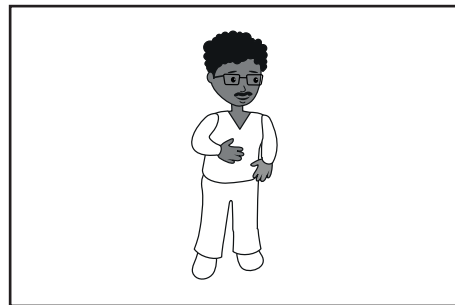
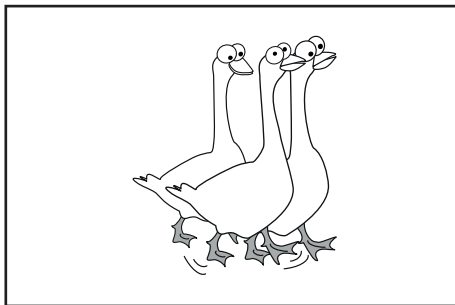
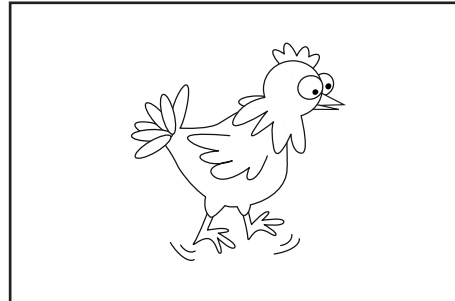
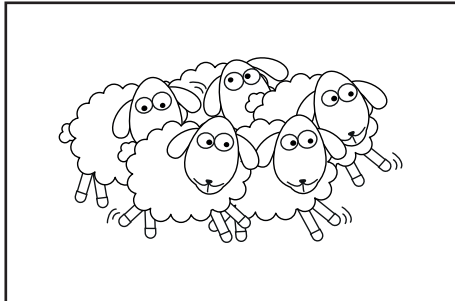

# Exercice 18

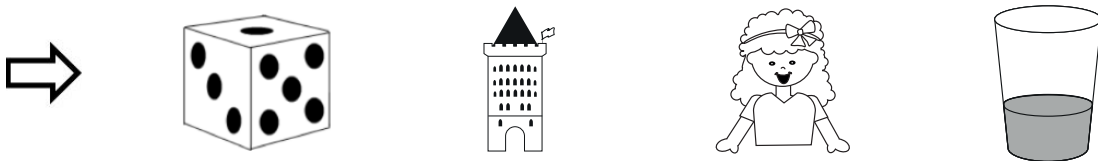
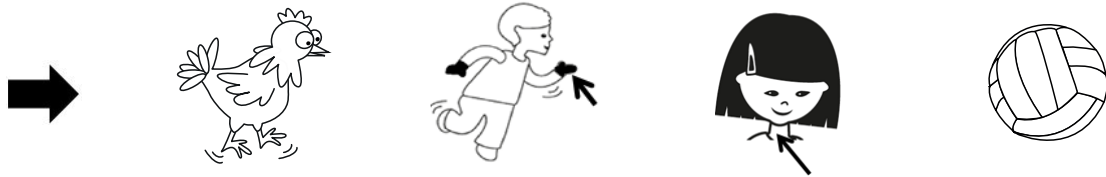
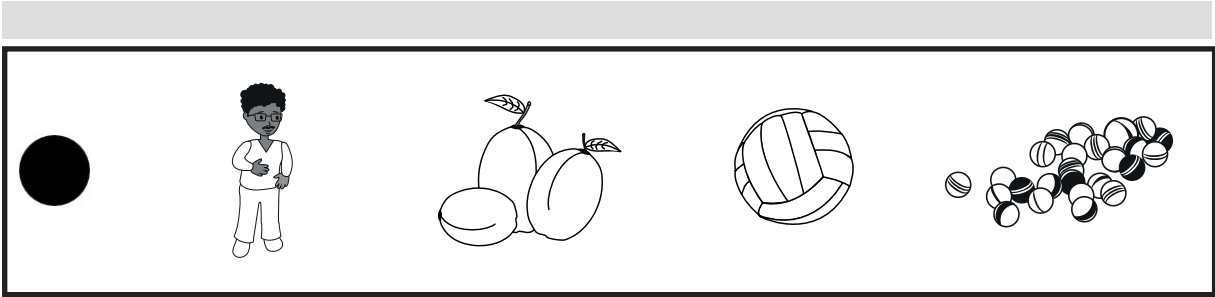



## Exercice 18 (suite)

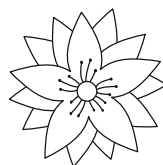
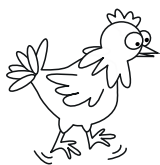
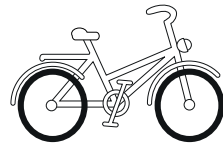
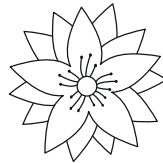
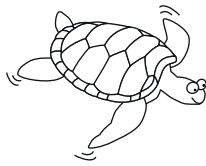
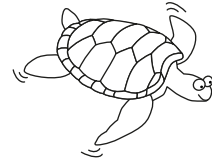
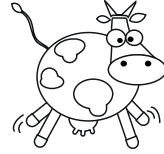
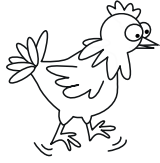

# Exercice 19

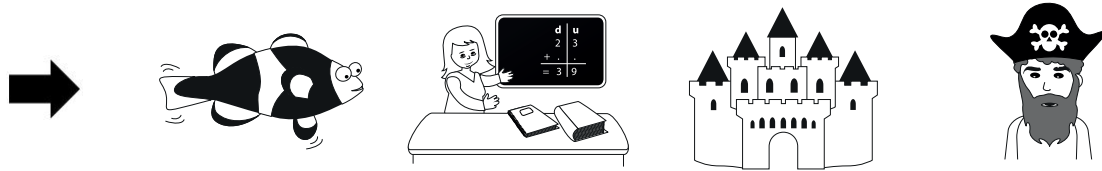
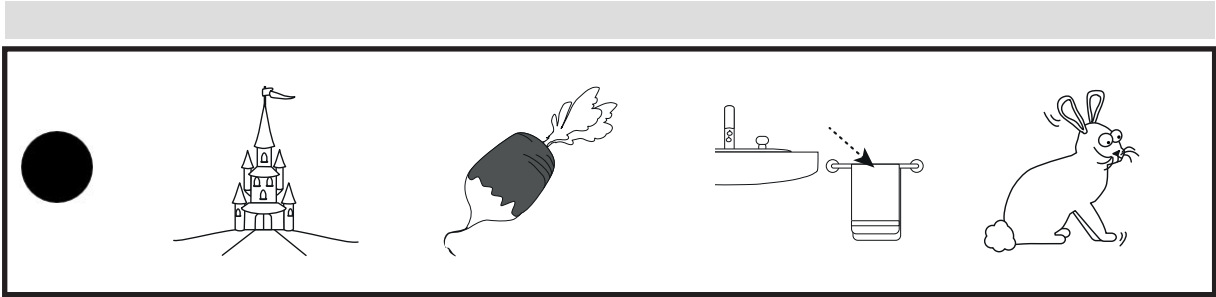

## Exercice 19 (suite)

