

# REPÈRES

# CP 2023

CAHIER DE L'ADULTE ACCOMPAGNANT

**Prénom de l'élève**

**Nom de l'élève**

**Classe de l'élève**



# **SÉQUENCE 1**

---

## **FRANÇAIS**

# Exercise 1

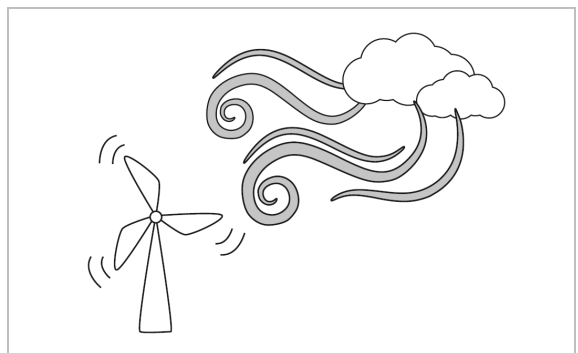
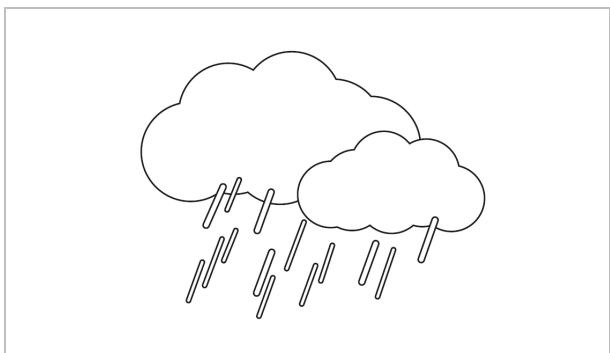
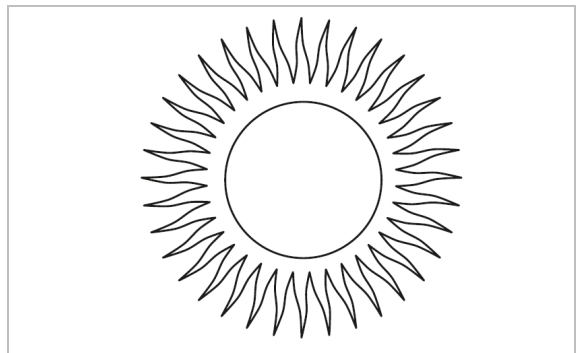
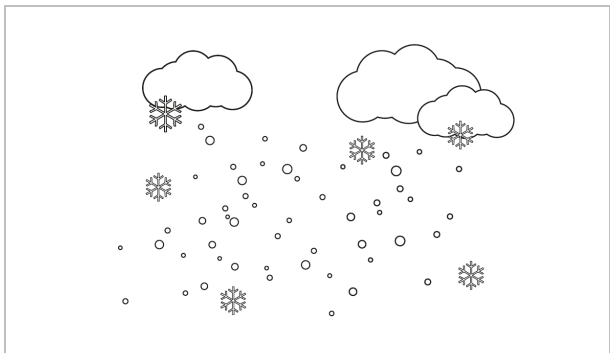
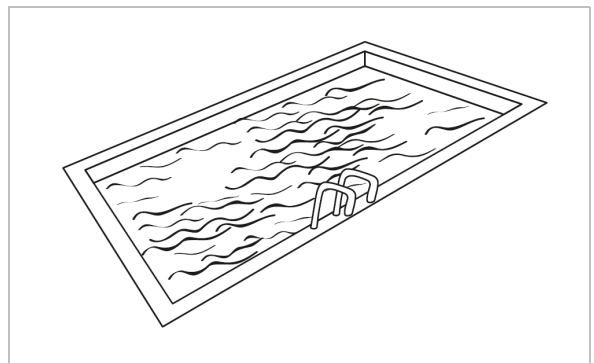
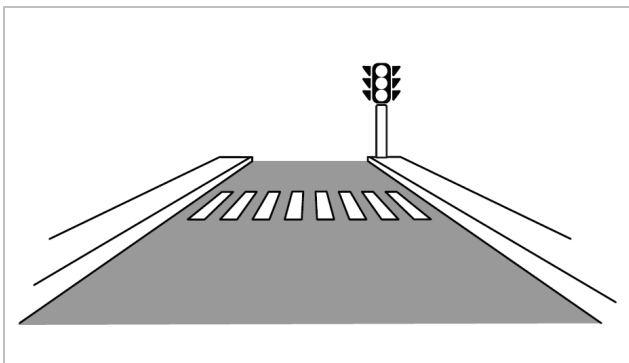
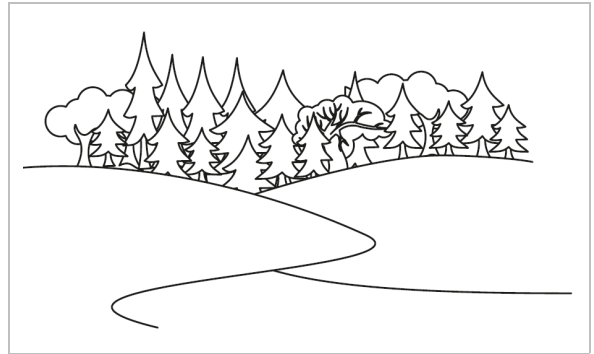

## Exercice 1 (suite)

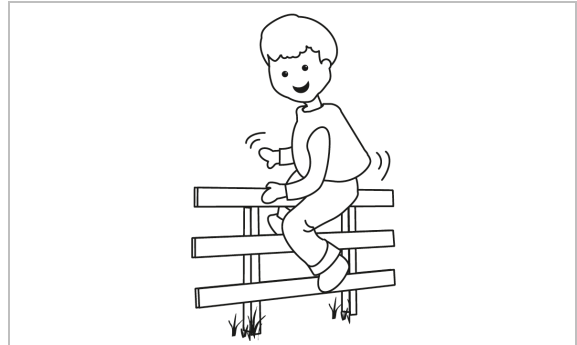
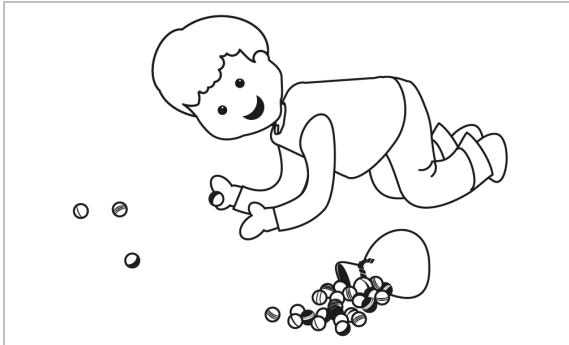

## Exercise 2

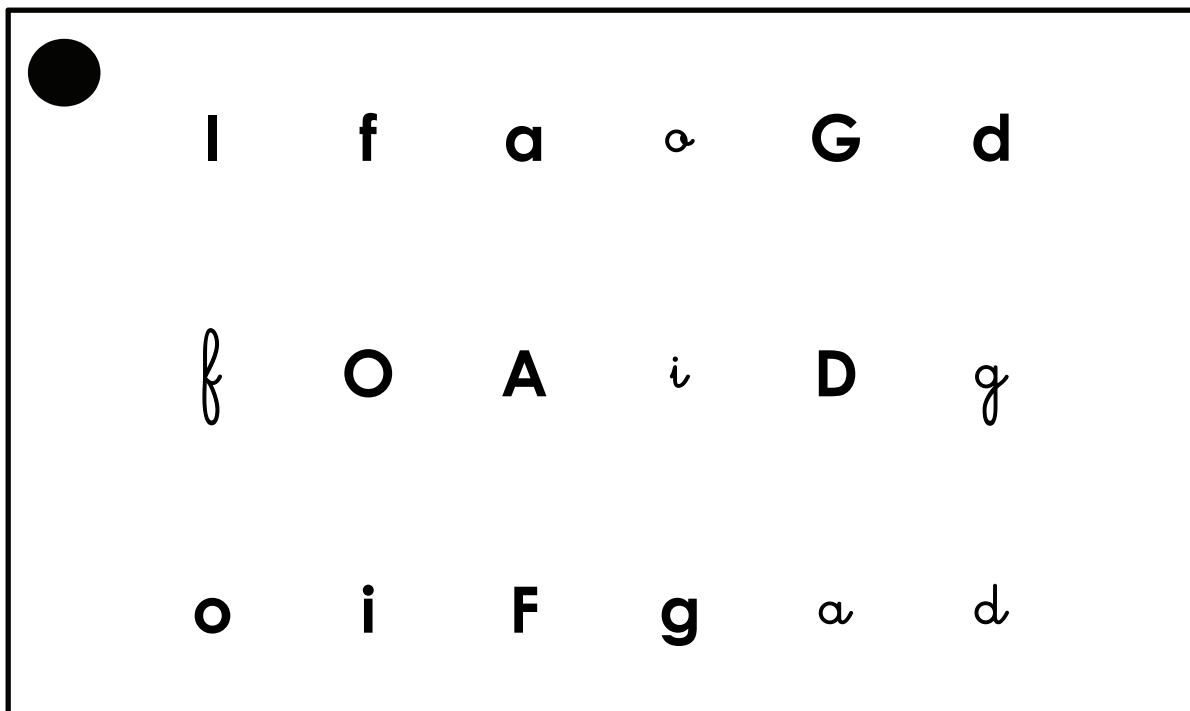

## Exercice 2 (suite)

---



**E**   **b**   **a**   *a*   **C**   **d**

*b*   **O**   **A**   *e*   **D**   *c*

**o**   **e**   **B**   **c**   *a*   *d*

## Exercice 2 (suite)

---



**E**   **b**   **a**   *a*   **C**   **d**

*b*   **O**   **A**   *e*   **D**   *c*

**o**   **e**   **B**   **c**   *a*   *d*



## Exercice 2 (suite)

---



**E**   **b**   **a**   *a*   **C**   **d**

*b*   **O**   **A**   *e*   **D**   *c*

**o**   **e**   **B**   **c**   *a*   *d*

## Exercice 2 (suite)

---



**E**   **b**   **a**   *a*   **C**   **d**

*b*   **O**   **A**   *e*   **D**   *c*

**o**   **e**   **B**   **c**   *a*   *d*

## Exercice 2 (suite)

---



**E**   **b**   **a**   *a*   **C**   **d**

*b*   **O**   **A**   *e*   **D**   *c*

**o**   **e**   **B**   **c**   *a*   *d*

## Exercice 2 (suite)

---



**E**   **b**   **a**   *a*   **C**   **d**

*b*   **O**   **A**   *e*   **D**   *c*

**o**   **e**   **B**   **C**   *a*   *d*

## Exercice 2 (suite)

---



**R**   **v**   **m**   *n*   **S**   **d**

*v*   **N**   **M**   *n*   **D**   *s*

**n**   **r**   **V**   **s**   *m*   **d**

### Exercise 3

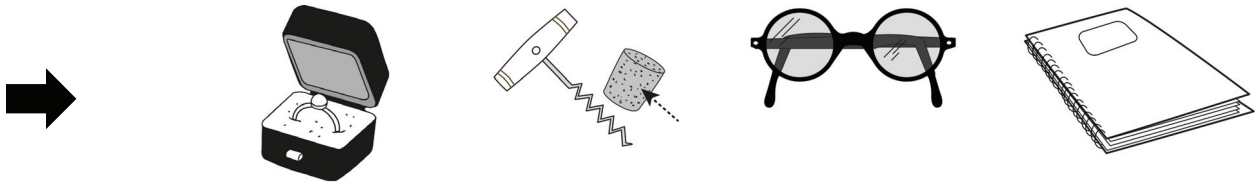
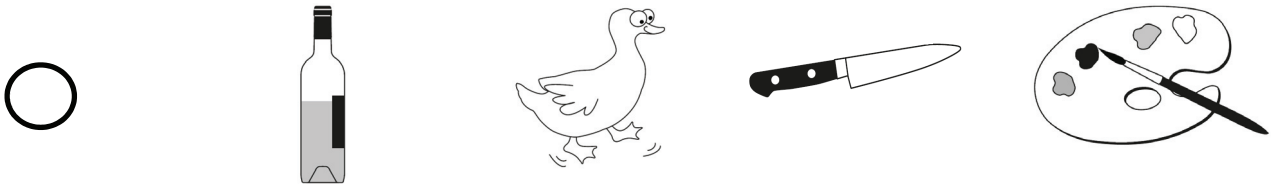
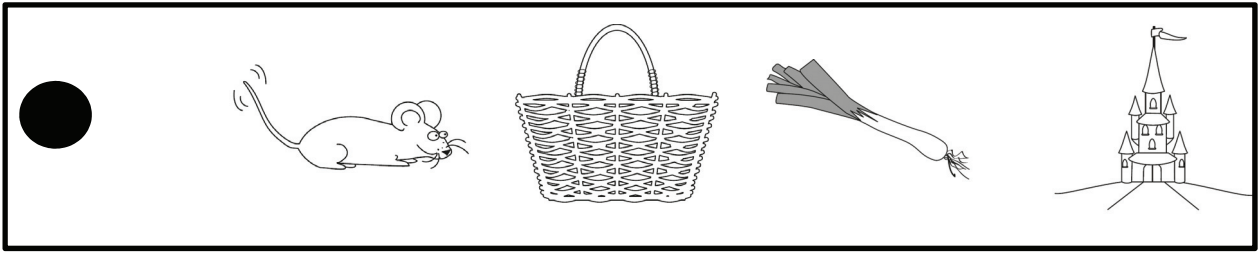

## Exercice 3 (suite)

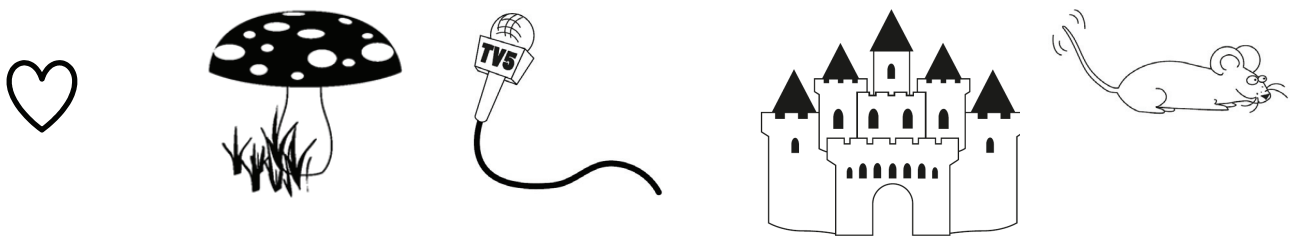
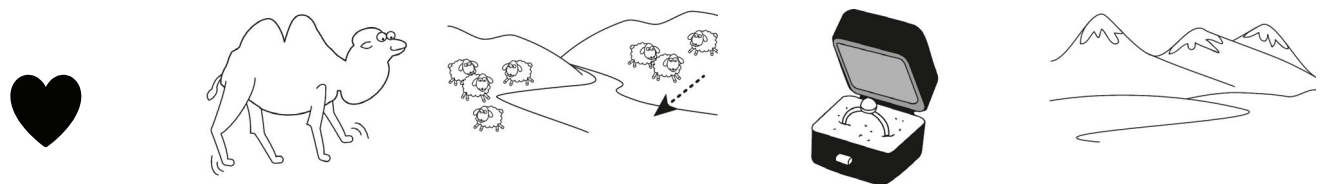
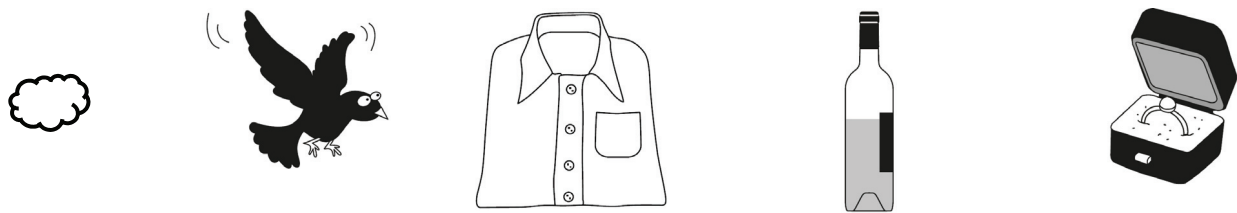
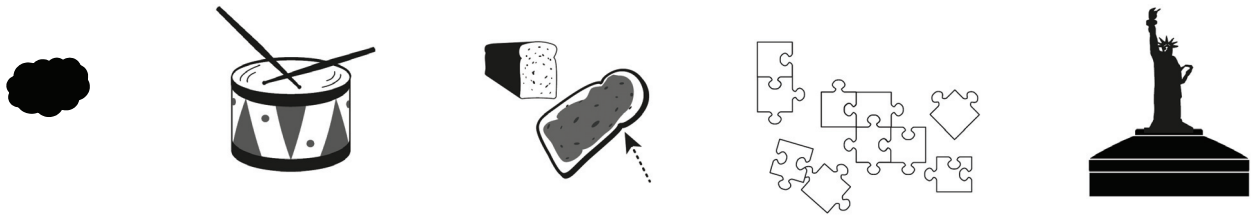





# **SÉQUENCE 2**

---

# **MATHÉMATIQUES**

## Exercise 4

●	2	10	7	1	9	6
---	---	----	---	---	---	---

○	0	6	3	2	5	1
---	---	---	---	---	---	---

➔	7	4	1	3	5	2
---	---	---	---	---	---	---

➔	2	8	6	0	10	9
---	---	---	---	---	----	---

■	1	10	0	6	8	2
---	---	----	---	---	---	---

□	7	1	2	10	5	3
---	---	---	---	----	---	---

## Exercice 4 (suite)

---



0	2	9	10	1	7
---	---	---	----	---	---



0	6	3	2	5	1
---	---	---	---	---	---



7	4	1	3	5	2
---	---	---	---	---	---



2	8	6	0	10	9
---	---	---	---	----	---



0	2	9	10	1	7
---	---	---	----	---	---

## Exercise 5

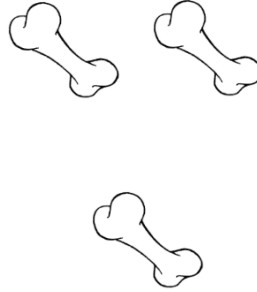
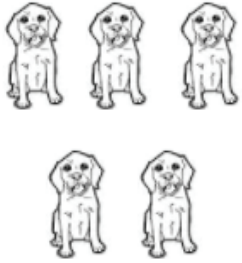

1

2

3

4

5

6

## Exercice 5 (suite)

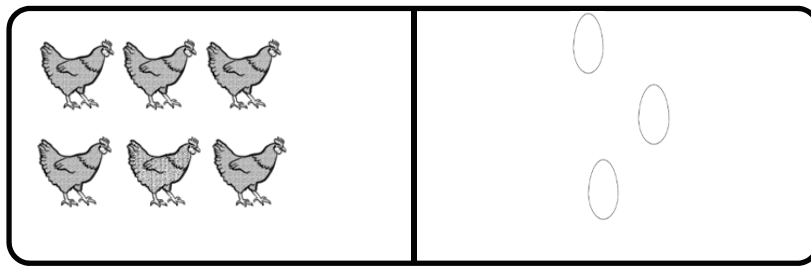

1 2 3 4 5 6



1 2 3 4 5 6





## Exercice 5 (suite)









1      2      3      4      5      6

## Exercise 6



---

									
1	2	3	4	5	6	7	8	9	10

---

									
									
1	2	3	4	5	6	7	8	9	10

---

									
									
1	2	3	4	5	6	7	8	9	10

## Exercice 6 (suite)

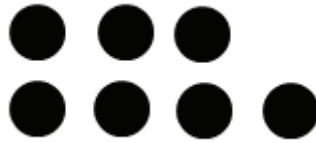

1	2	3	4	5	6	7	8	9	10
---	---	---	---	---	---	---	---	---	----

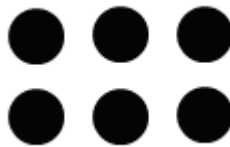

1	2	3	4	5	6	7	8	9	10
---	---	---	---	---	---	---	---	---	----

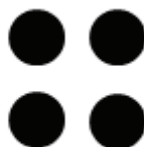

1	2	3	4	5	6	7	8	9	10
---	---	---	---	---	---	---	---	---	----



## Exercice 6 (suite)

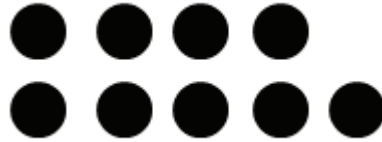

1	2	3	4	5	6	7	8	9	10
---	---	---	---	---	---	---	---	---	----

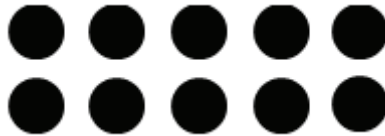

1	2	3	4	5	6	7	8	9	10
---	---	---	---	---	---	---	---	---	----

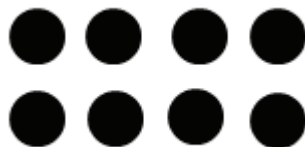

1	2	3	4	5	6	7	8	9	10
---	---	---	---	---	---	---	---	---	----

## Exercice 7

### Exemples

1	<del>3</del>
6	3
4	5
9	7

## Exercice 7 (suite)

8	9	7	4	5	6	4	1
2	6	5	9	4	3	9	6
5	4	7	6	2	1	5	8
3	2	5	1	9	8	3	4
4	1	8	9	4	5	2	6
2	5	1	4	8	7	5	1
3	6	8	5	2	3	9	8
8	4	1	2	6	7	5	4
6	7	4	3	9	5	1	2
2	1	5	6	4	8	7	6



# **SÉQUENCE 3**

---

## **FRANÇAIS**

## Exercise 8

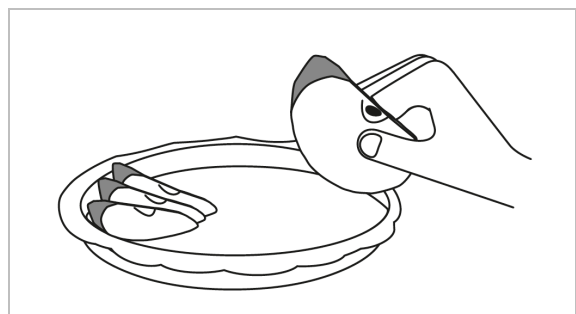
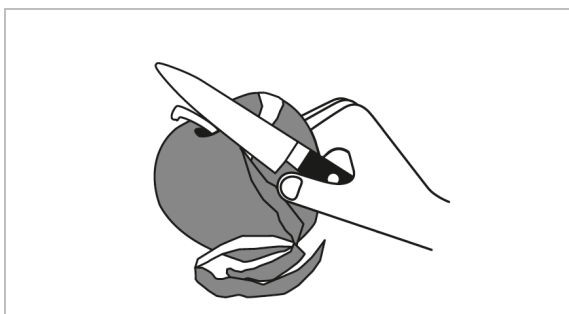
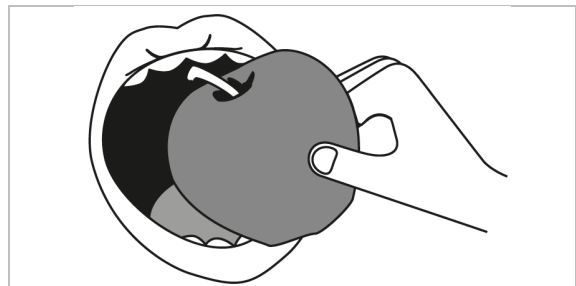
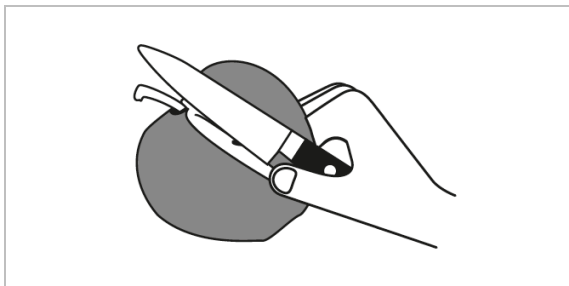
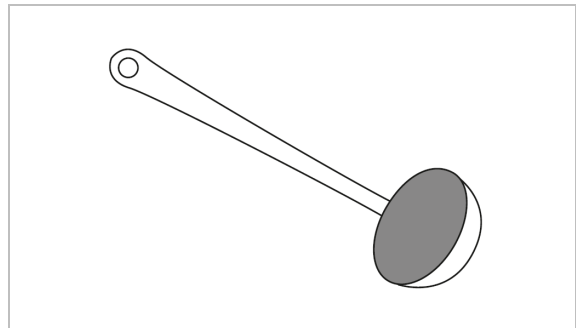
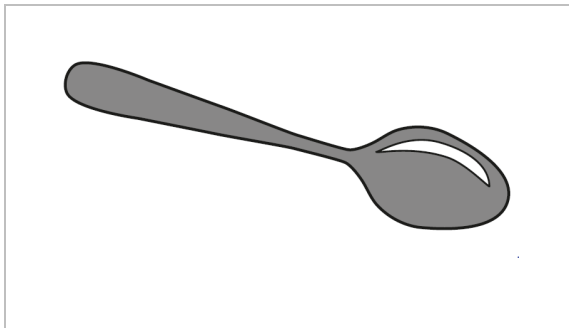
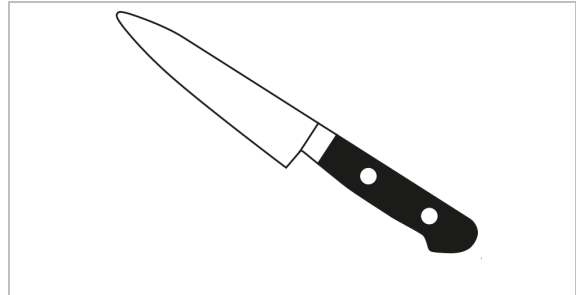
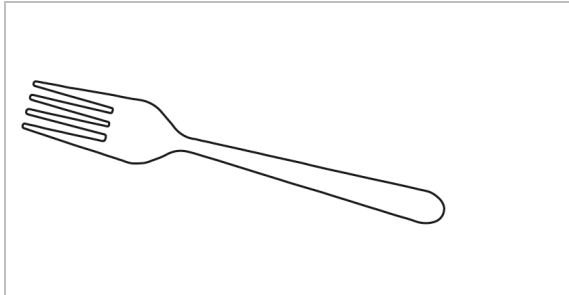

## Exercice 8 (suite)

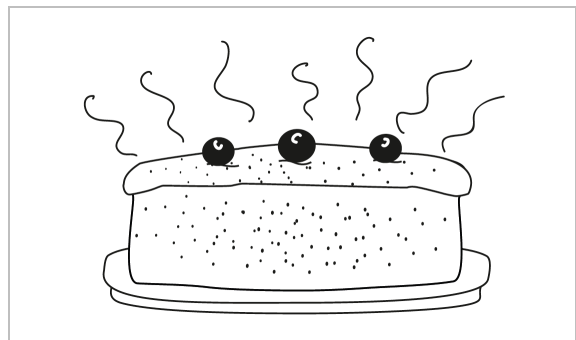
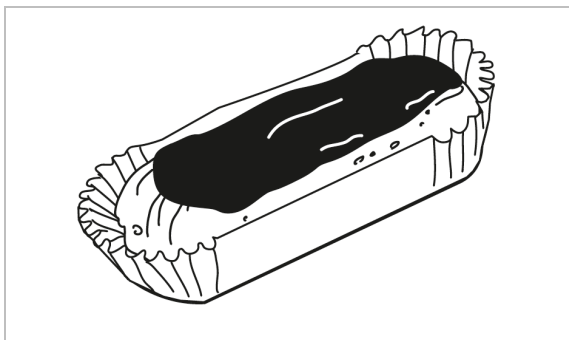
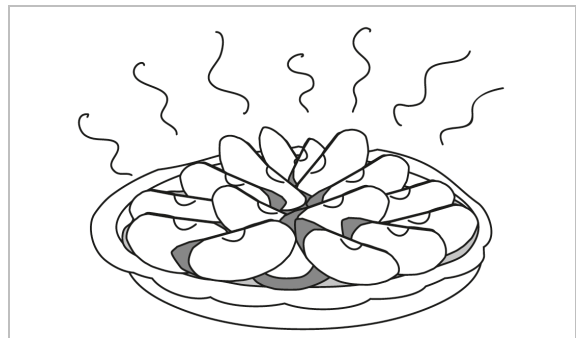
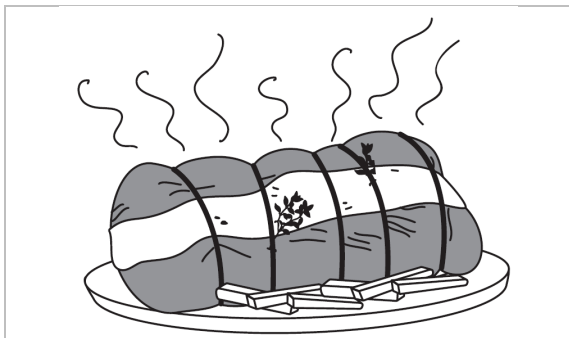
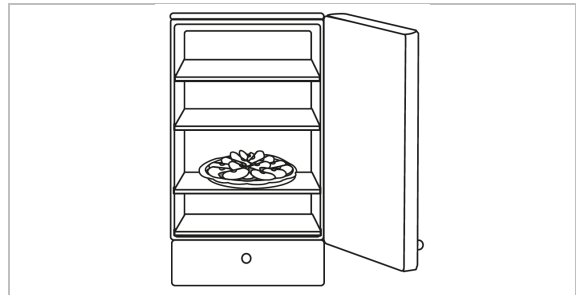
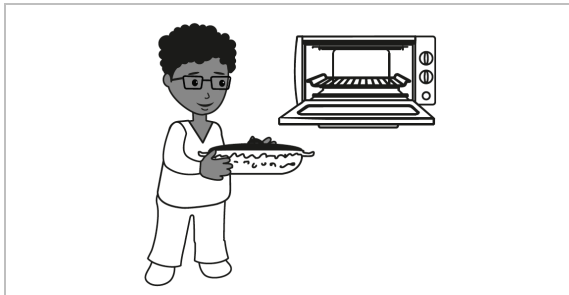
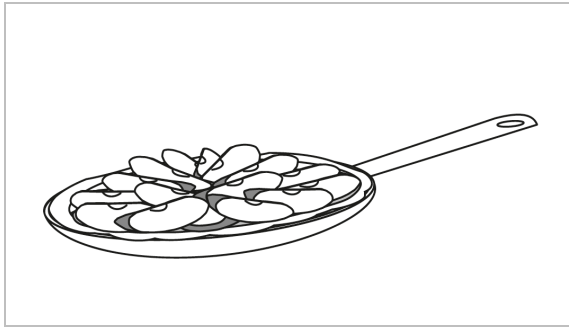

## Exercise 9

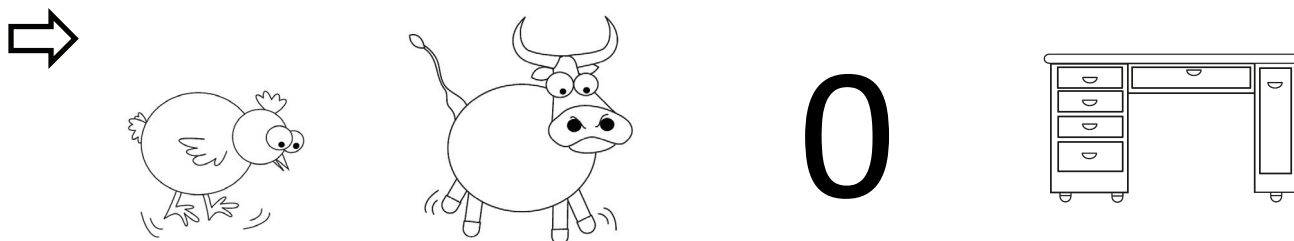
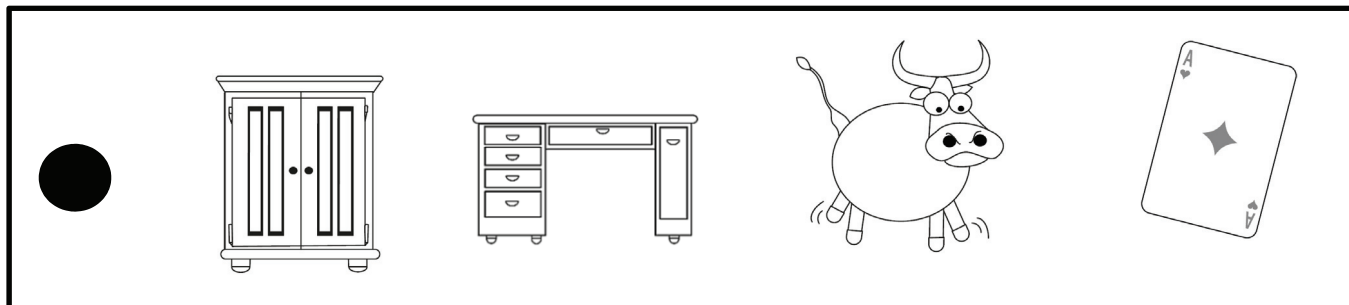



## Exercice 9 (suite)

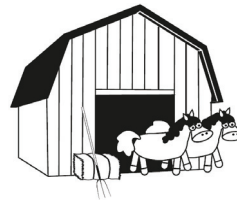
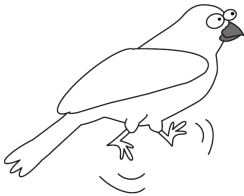
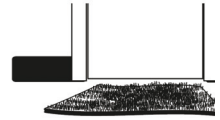
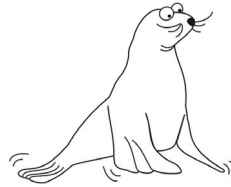

# **SÉQUENCE 4**

---

# **MATHÉMATIQUES**

## Exercice 10

---

L'élève utilise son matériel habituel pour écrire.

## Exercise 11

---

--	--	--	--	--	--	--

1 2 3 4 5 6

--	--	--	--	--	--	--

1 2 3 4 5 6

## Exercice 11 (suite)

---



--	--	--	--	--	--	--

1 2 3 4 5 6



--	--	--	--	--	--	--

1 2 3 4 5 6

## Exercise 12

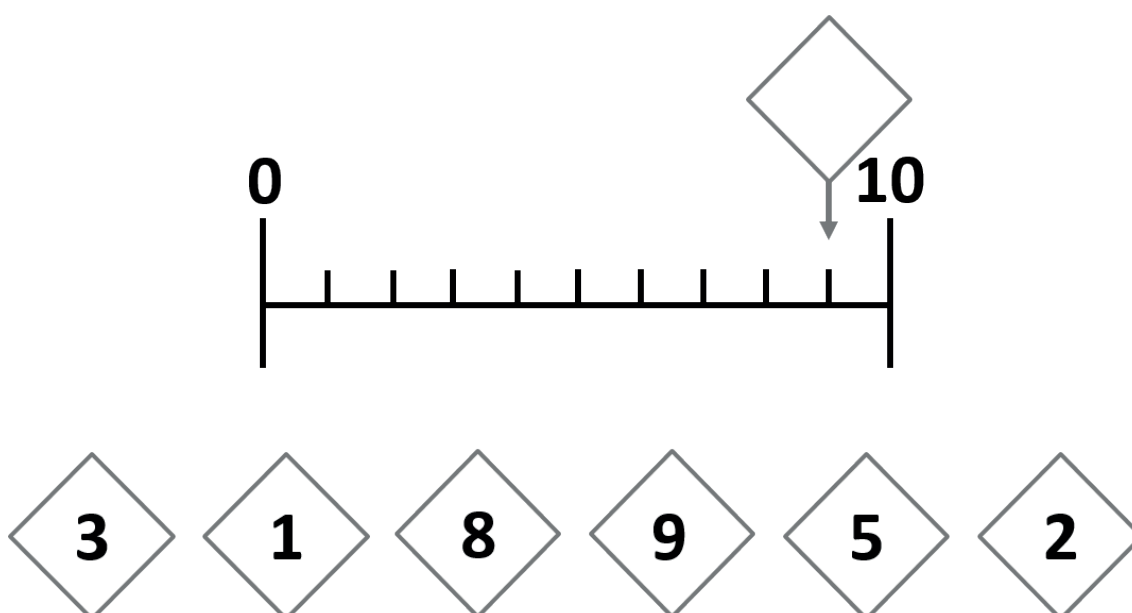
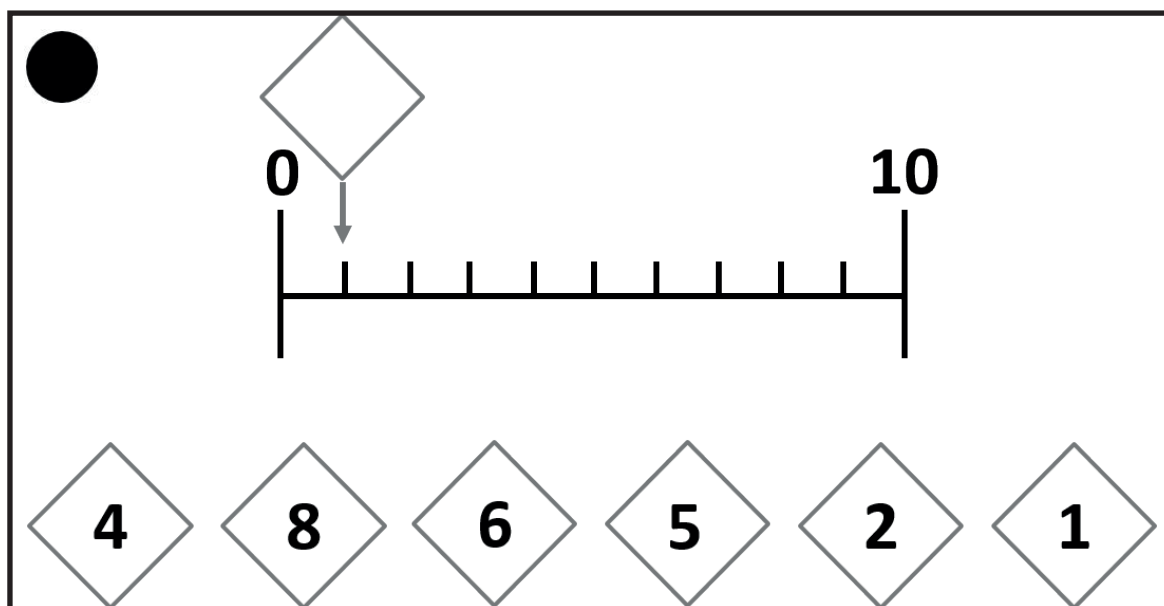

## Exercice 12 (suite)

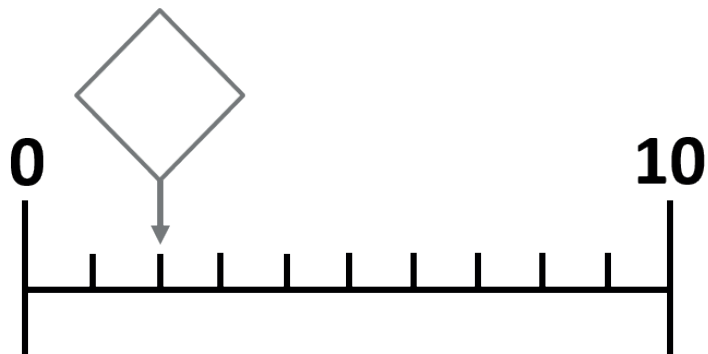
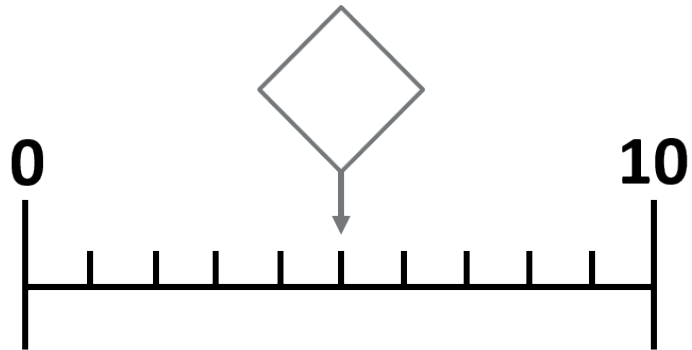

## Exercice 12 (suite)

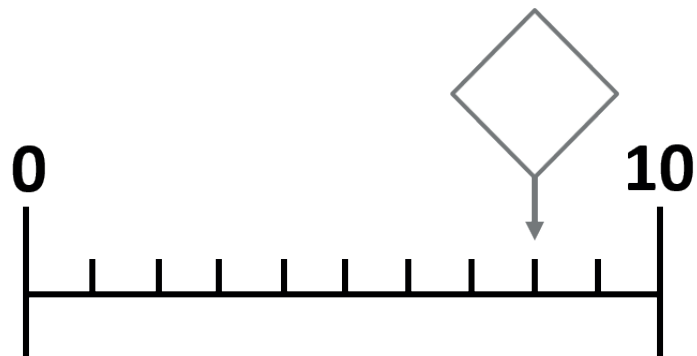
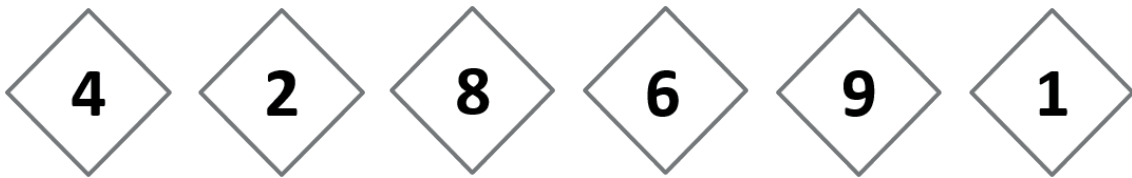
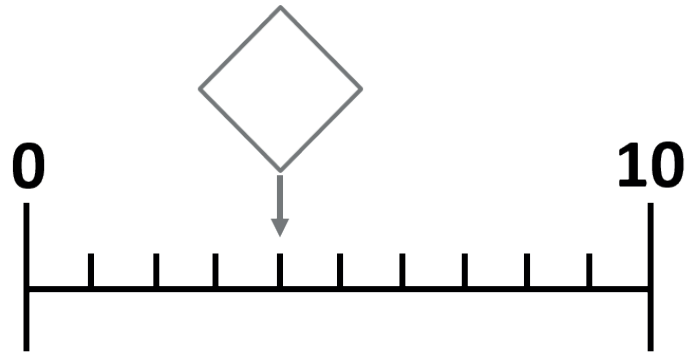



## Exercice 12 (suite)

---

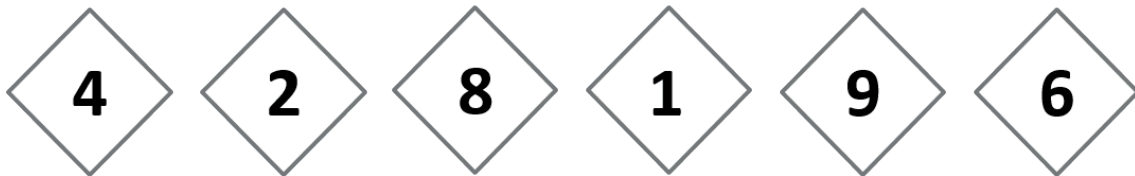
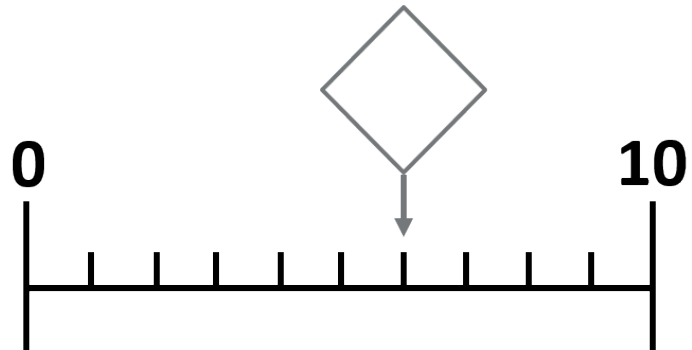

# **SÉQUENCE 5**

---

## **FRANÇAIS**

## Exercise 13

---

● m n b d f

○ s r p t f

---

➔ m s r b d

---

➞ m b d f j

---

■ l t d h f

---

## Exercice 13 (suite)

---

 m b d f n

---

 h l v b d

---

 n m r t v

---

 n m r t s

---

 n d t s f

---

 n m v u f

---

## Exercise 14

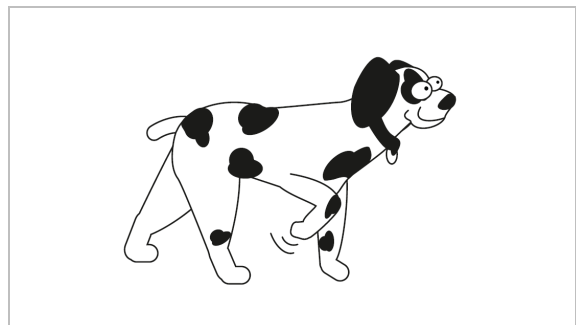
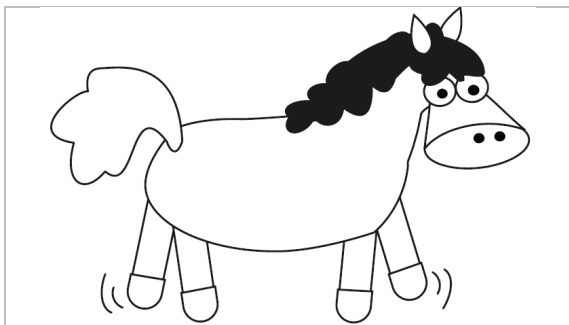
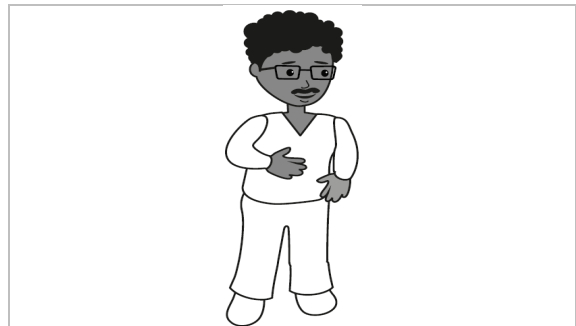
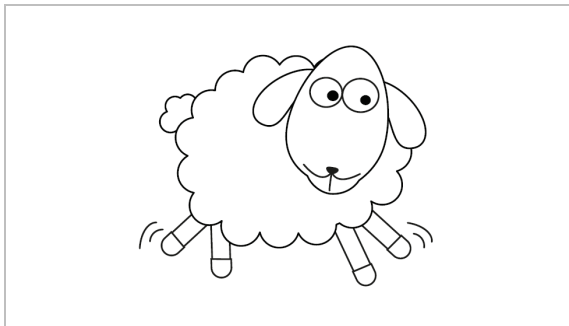
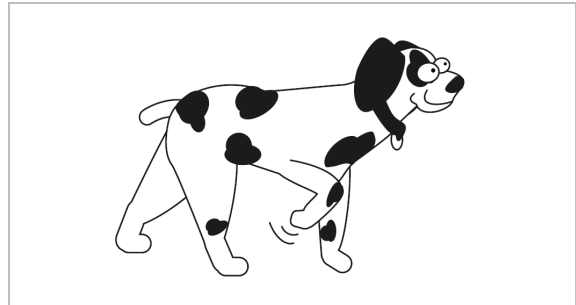
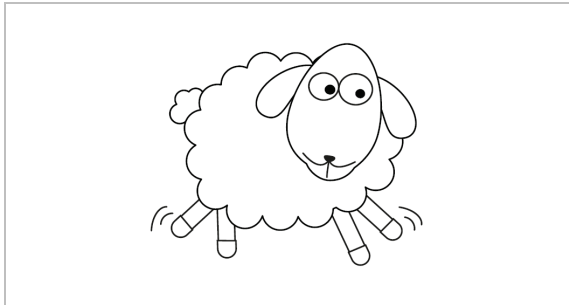
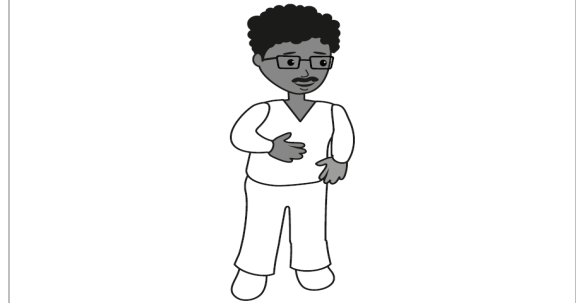
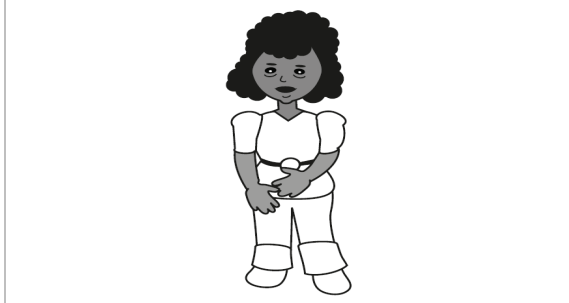

## Exercice 14 (suite)

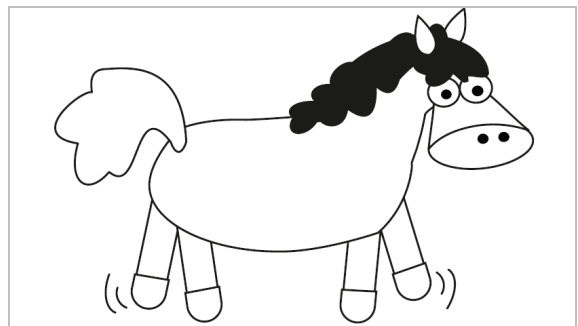
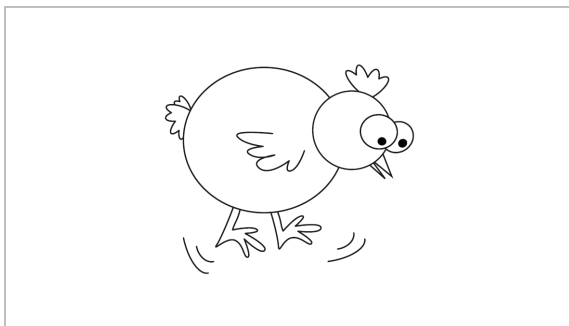
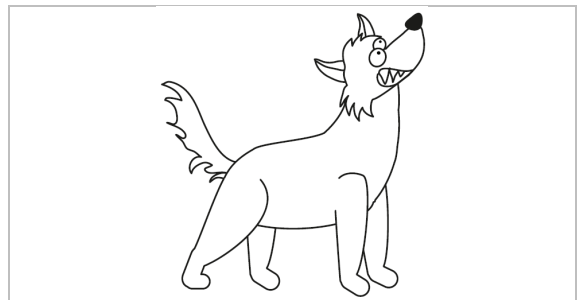
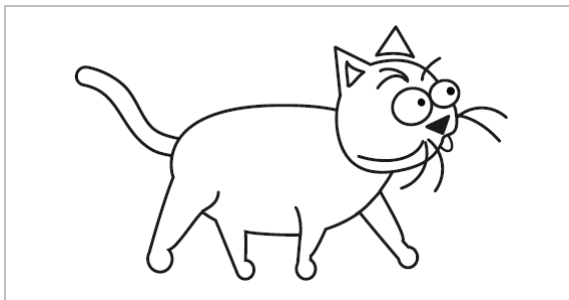
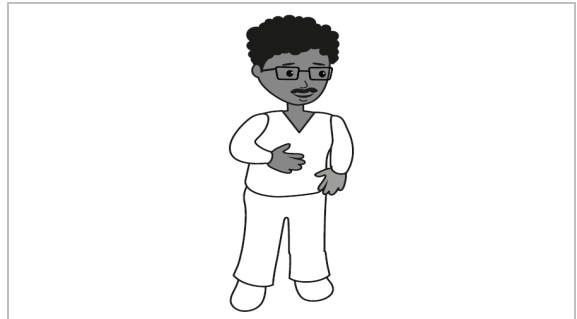
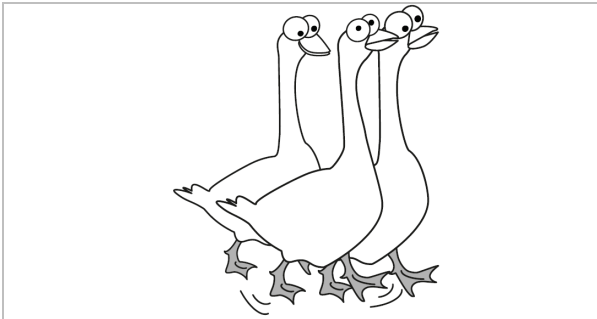
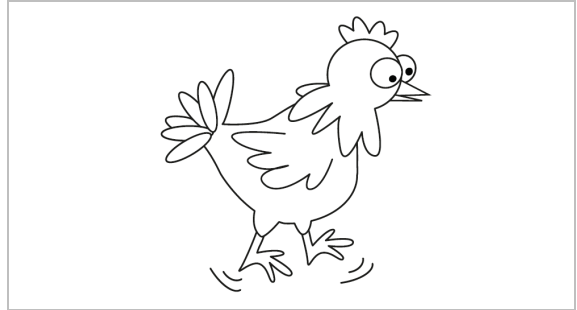
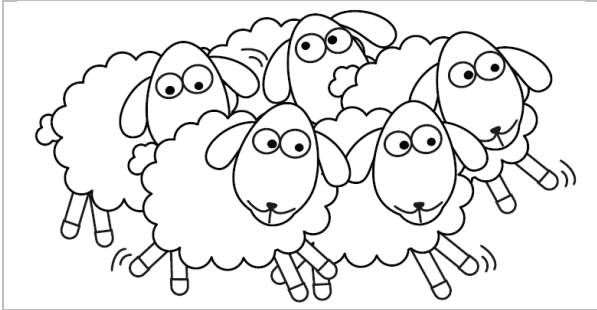

# Exercise 15

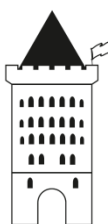
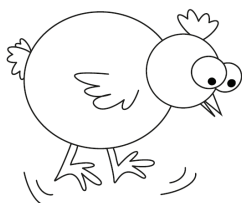
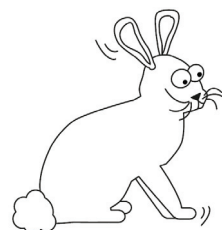
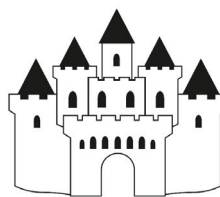
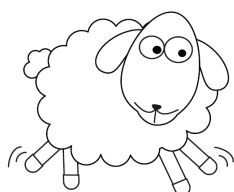
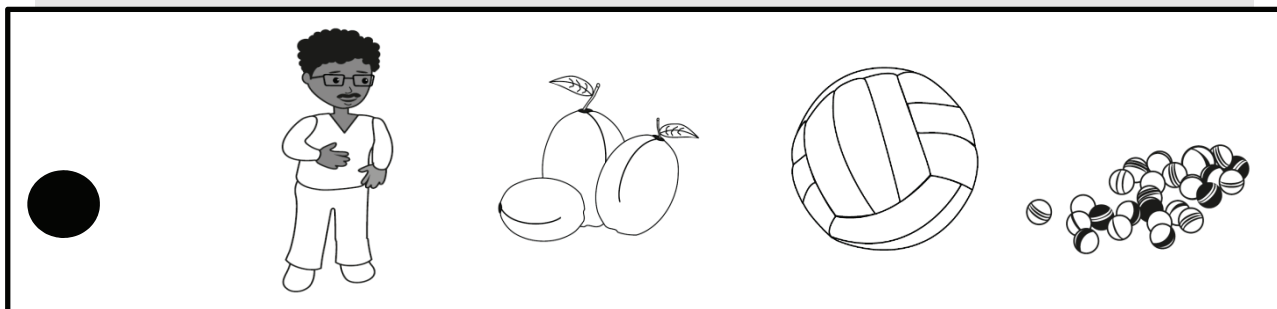

## Exercice 15 (suite)

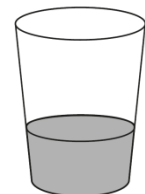
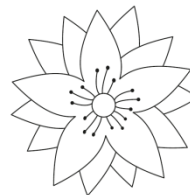
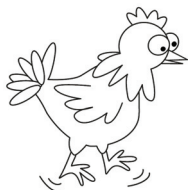
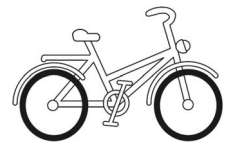
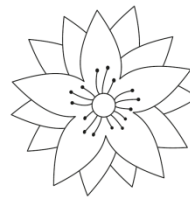
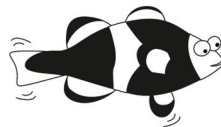
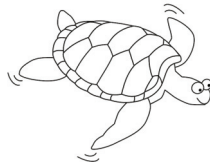
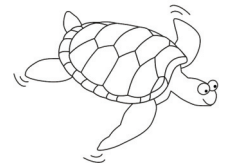
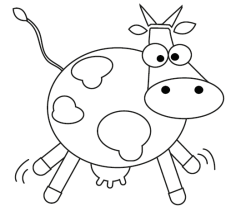



## Exercise 16

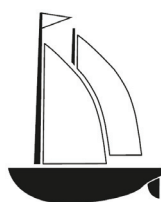
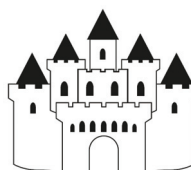
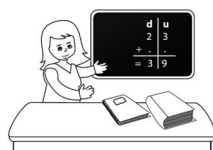
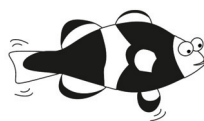
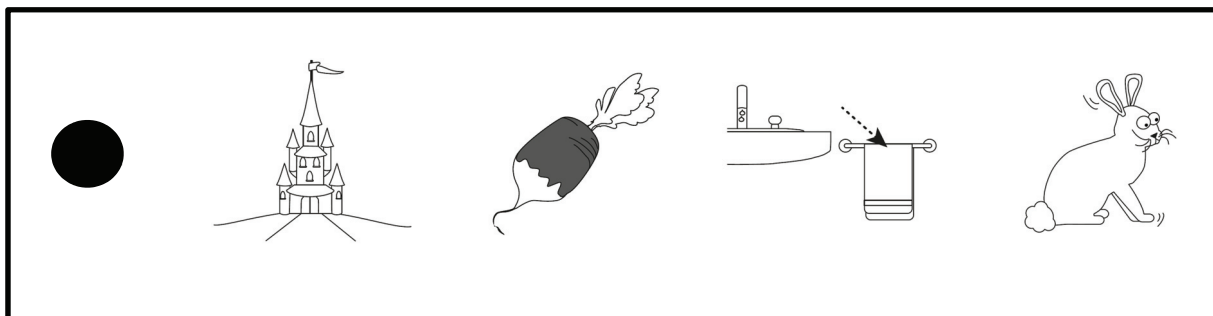

## Exercice 16 (suite)

