



MINISTÈRE
DE L'ÉDUCATION
NATIONALE,
DE LA JEUNESSE
ET DES SPORTS

*Liberté
Égalité
Fraternité*

REPÈRES

CP 2022

CAHIER DE L'ADULTE ACCOMPAGNANT

Prénom de l'élève

Nom de l'élève

Classe de l'élève



SÉQUENCE 1

FRANÇAIS

Exercise 1

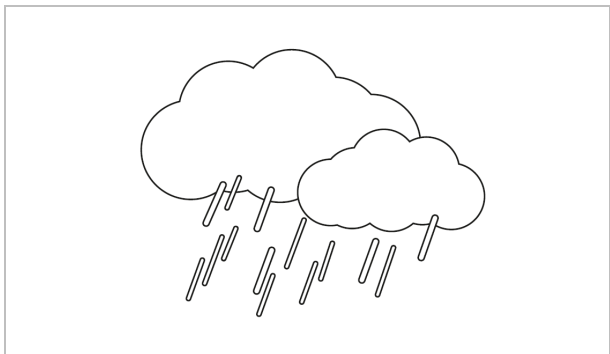
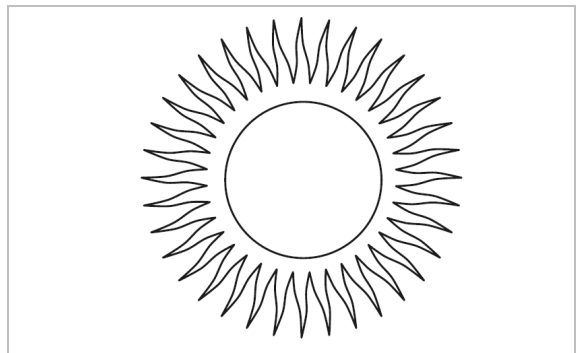
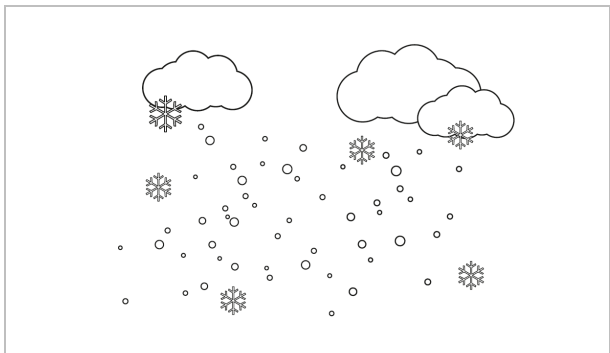
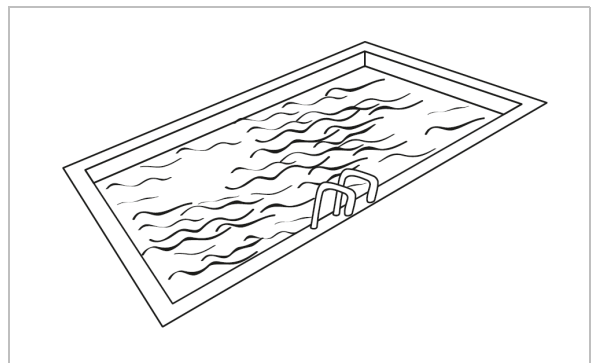
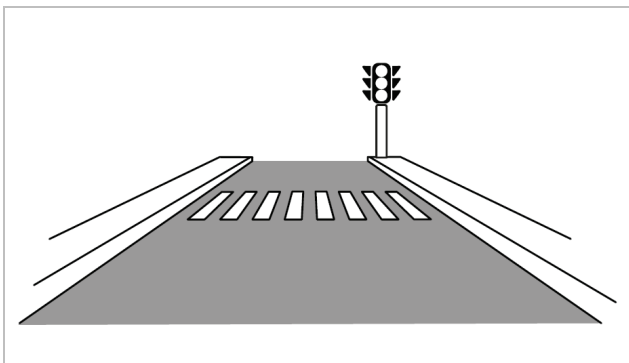
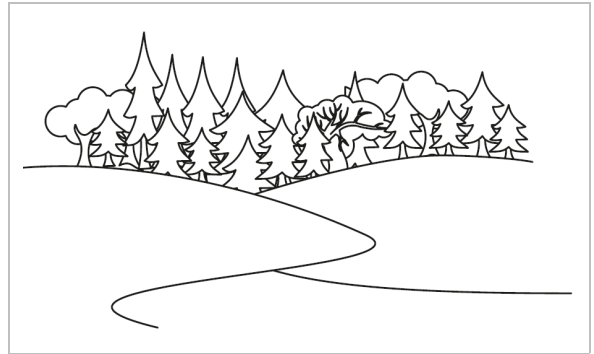
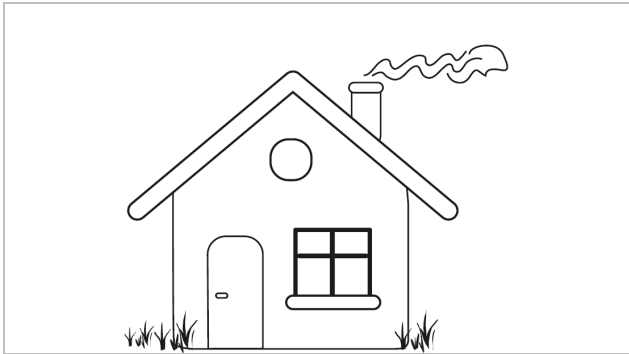

Exercice 1 (suite)

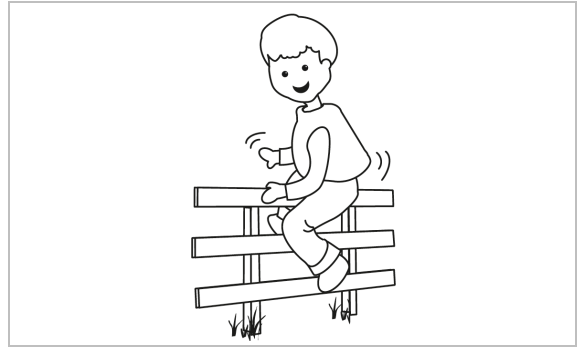
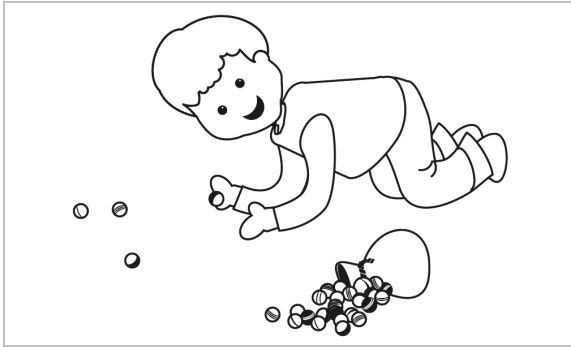

Exercice 2

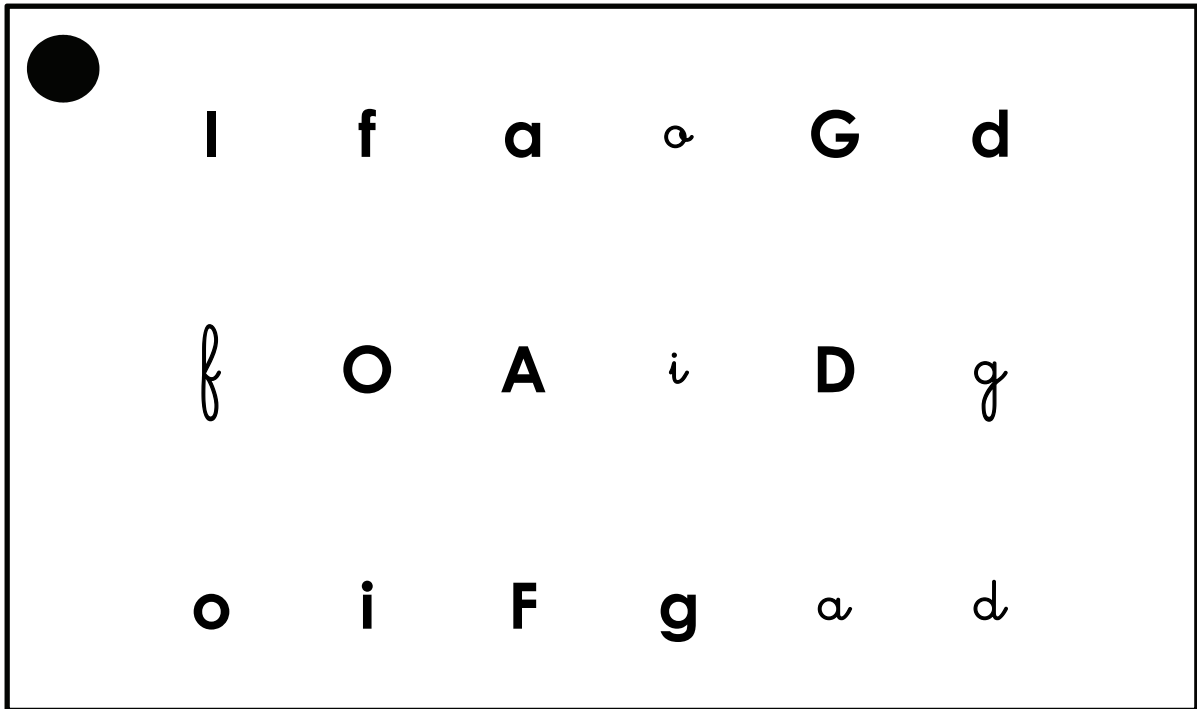

Exercice 2 (suite)



E **b** **a** *a* **C** **d**

b **O** **A** *e* **D** *c*

o **e** **B** **c** *a* *d*

Exercice 2 (suite)



E **b** **a** *a* **C** **d**

b **O** **A** *e* **D** *c*

o **e** **B** **c** *a* *d*

Exercice 2 (suite)



E **b** **a** *a* **C** **d**

b **O** **A** *e* **D** *c*

o **e** **B** **c** *a* *d*

Exercice 2 (suite)



E **b** **a** *a* **C** **d**

b **O** **A** *e* **D** *c*

o **e** **B** **c** *a* *d*

Exercice 2 (suite)



E **b** **a** *a* **C** **d**

b **O** **A** *e* **D** *c*

o **e** **B** **c** *a* *d*

Exercice 2 (suite)



E **b** **a** *a* **C** **d**

b **O** **A** *e* **D** *c*

o **e** **B** **C** *a* *d*

Exercice 2 (suite)



R **v** **m** *n* **S** **d**

v **N** **M** *n* **D** *s*

n **r** **V** **s** *m* **d**

Exercise 3

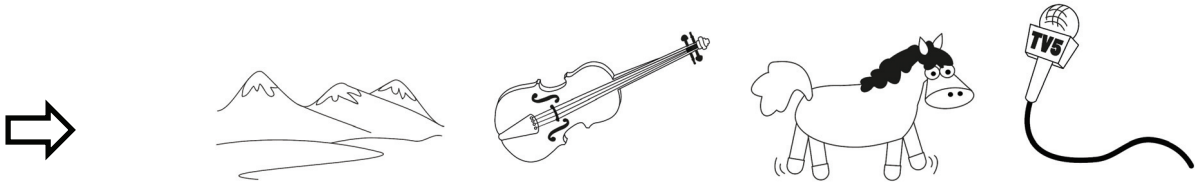
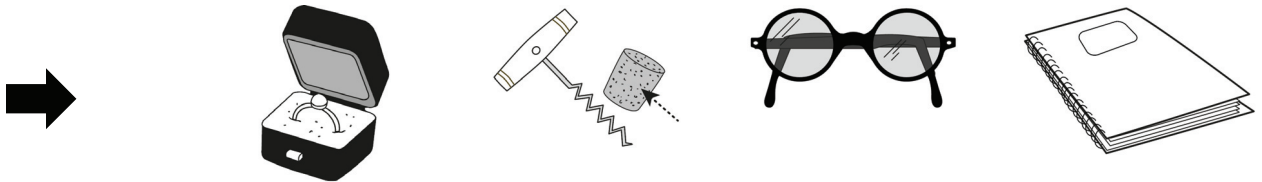
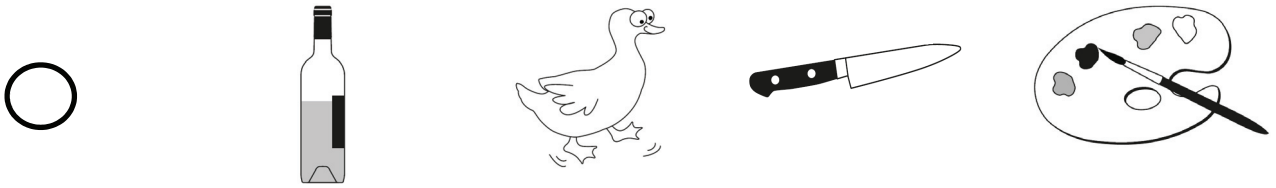
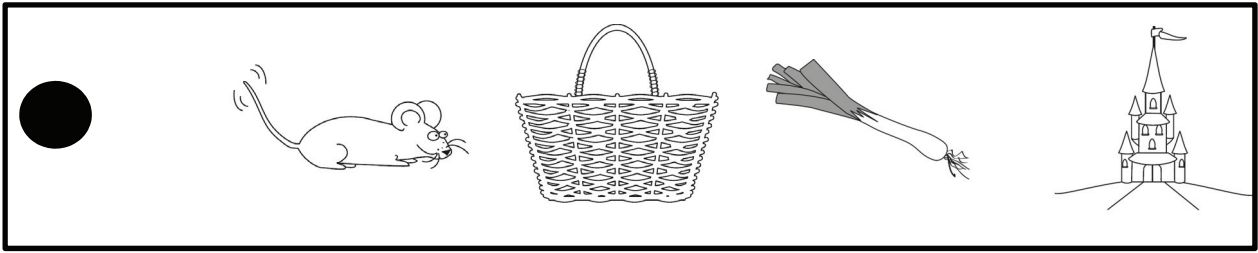

Exercice 3 (suite)

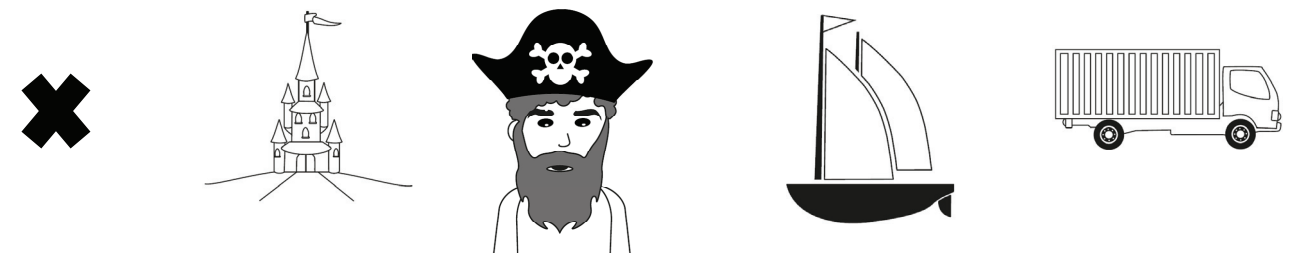
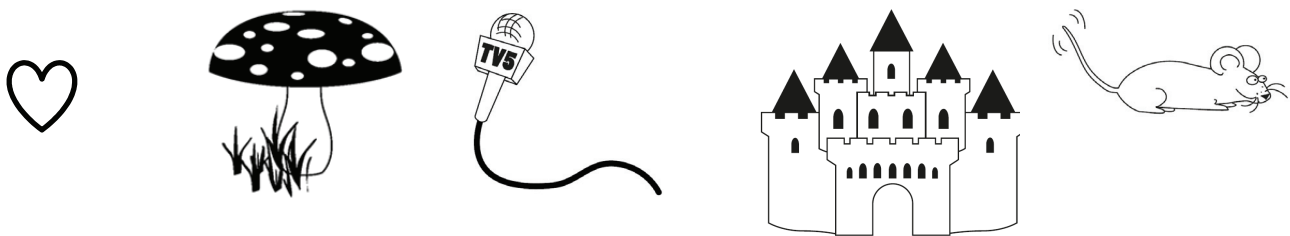
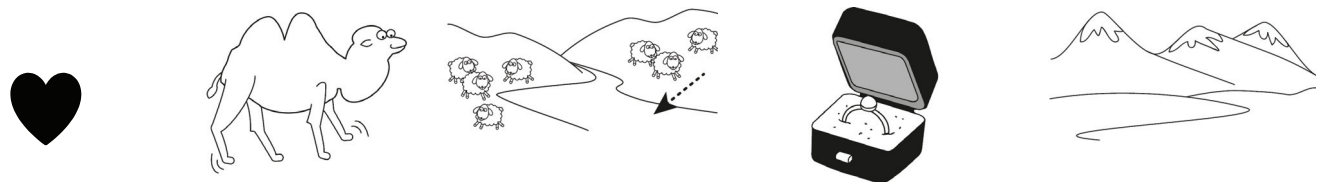
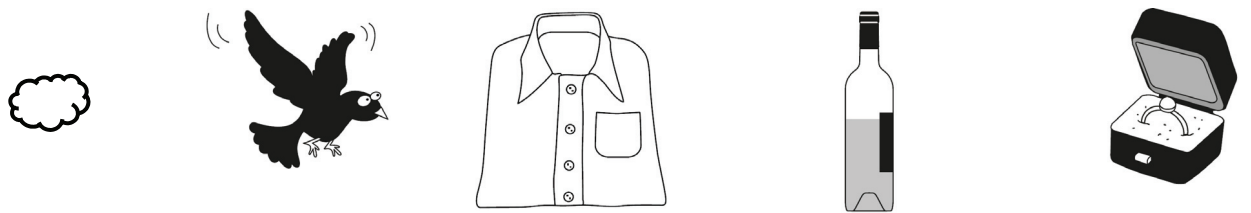
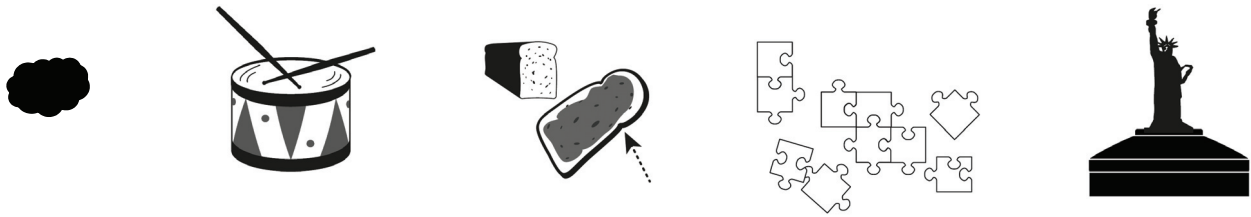

SÉQUENCE 2

MATHÉMATIQUES

Exercise 4

●	2	10	7	1	9	6
---	---	----	---	---	---	---

○	0	6	3	2	5	1
---	---	---	---	---	---	---

➔	7	4	1	3	5	2
---	---	---	---	---	---	---

➔	2	8	6	0	10	9
---	---	---	---	---	----	---

■	1	10	0	6	8	2
---	---	----	---	---	---	---

□	7	1	2	10	5	3
---	---	---	---	----	---	---

Exercice 4 (suite)



0	2	9	10	1	7
---	---	---	----	---	---



0	6	3	2	5	1
---	---	---	---	---	---



7	4	1	3	5	2
---	---	---	---	---	---



2	8	6	0	10	9
---	---	---	---	----	---



0	2	9	10	1	7
---	---	---	----	---	---

Exercise 5

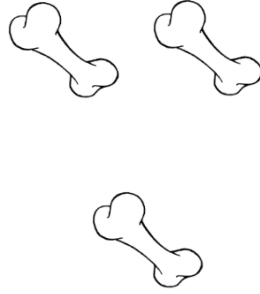
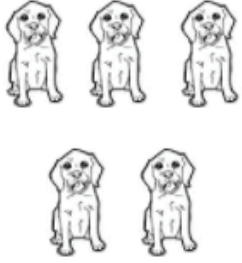

1

2

3

4

5

6

Exercice 5 (suite)

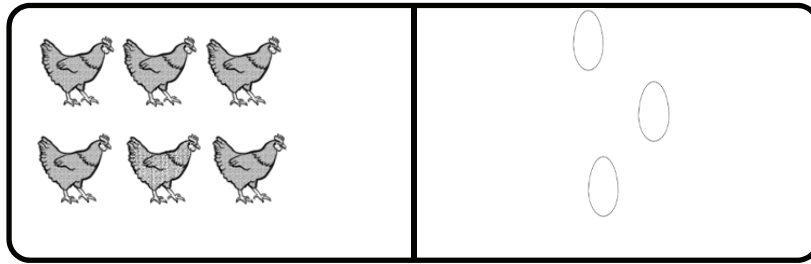

1 2 3 4 5 6

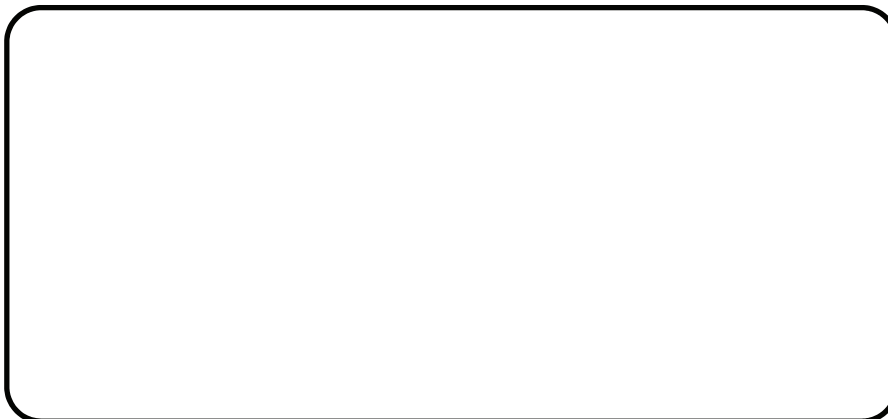
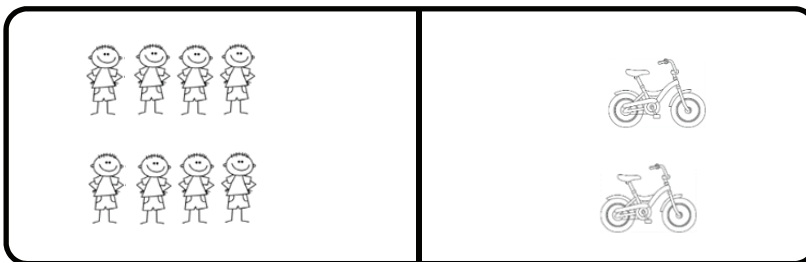





1 2 3 4 5 6







Exercice 5 (suite)





1 2 3 4 5 6

Exercise 6

									
									
1	2	3	4	5	6	7	8	9	10

									
									
									
1	2	3	4	5	6	7	8	9	10

									
									
1	2	3	4	5	6	7	8	9	10

Exercice 6 (suite)

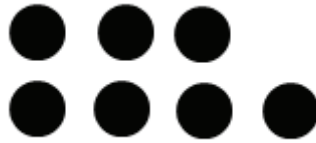

1	2	3	4	5	6	7	8	9	10
---	---	---	---	---	---	---	---	---	----

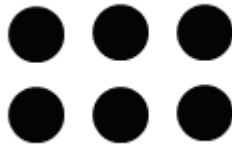

1	2	3	4	5	6	7	8	9	10
---	---	---	---	---	---	---	---	---	----

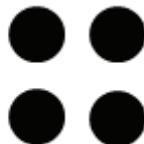

1	2	3	4	5	6	7	8	9	10
---	---	---	---	---	---	---	---	---	----

Exercice 6 (suite)

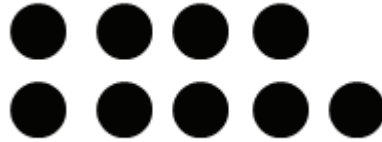

1	2	3	4	5	6	7	8	9	10
---	---	---	---	---	---	---	---	---	----

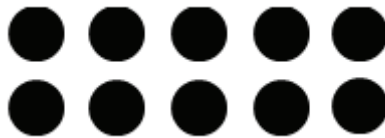

1	2	3	4	5	6	7	8	9	10
---	---	---	---	---	---	---	---	---	----

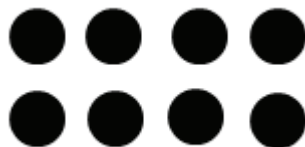

1	2	3	4	5	6	7	8	9	10
---	---	---	---	---	---	---	---	---	----

Exercice 7

Exemples

1	3
6	3
4	5
9	7

Exercice 7 (suite)

8	9	7	4	5	6	4	1
2	6	5	9	4	3	9	6
5	4	7	6	2	1	5	8
3	2	5	1	9	8	3	4
4	1	8	9	4	5	2	6
2	5	1	4	8	7	5	1
3	6	8	5	2	3	9	8
8	4	1	2	6	7	5	4
6	7	4	3	9	5	1	2
2	1	5	6	4	8	7	6

SÉQUENCE 3

FRANÇAIS

Exercise 8

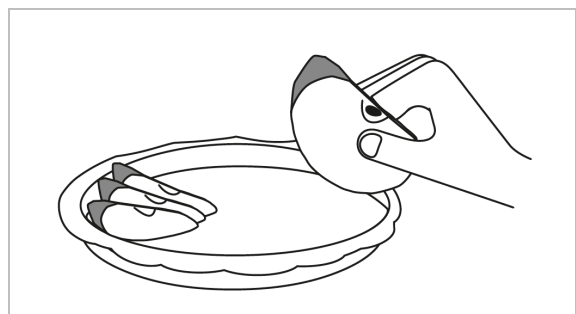
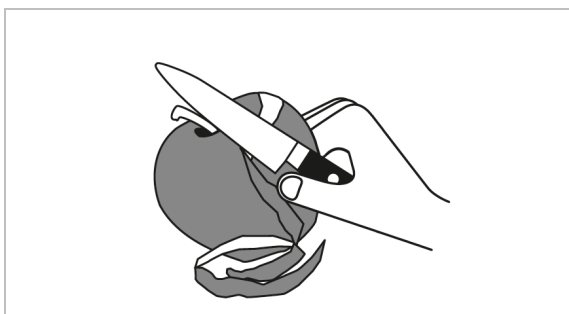
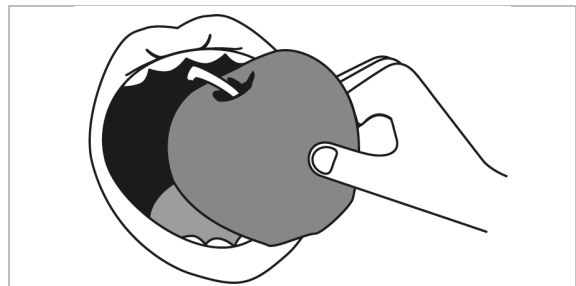
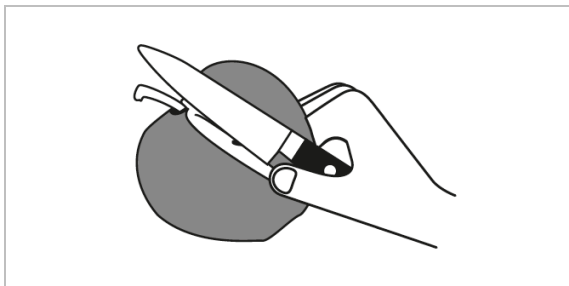
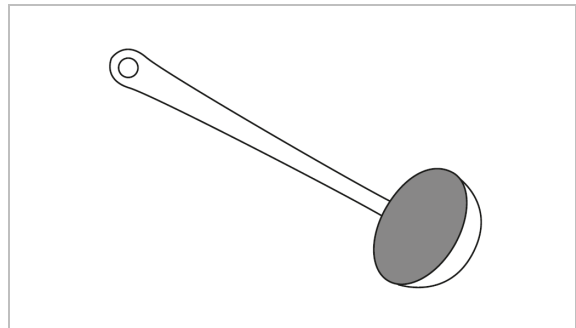
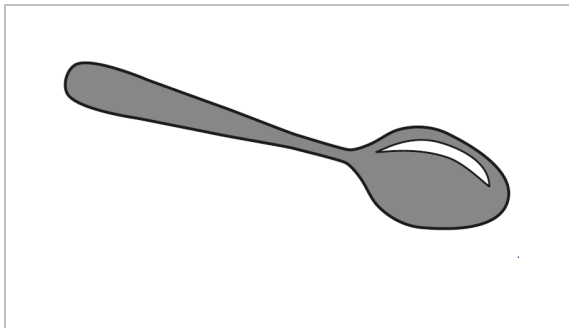
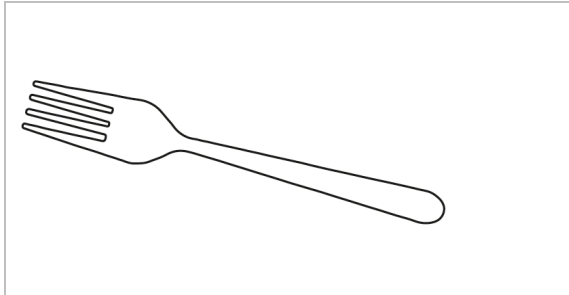

Exercice 8 (suite)

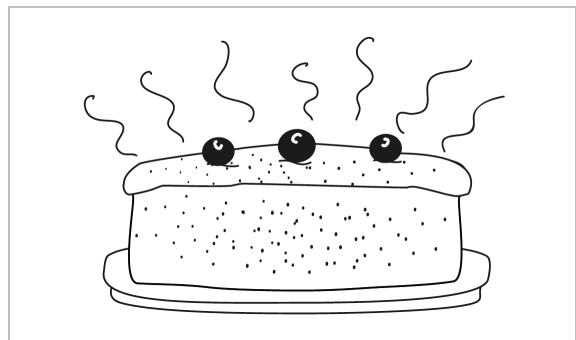
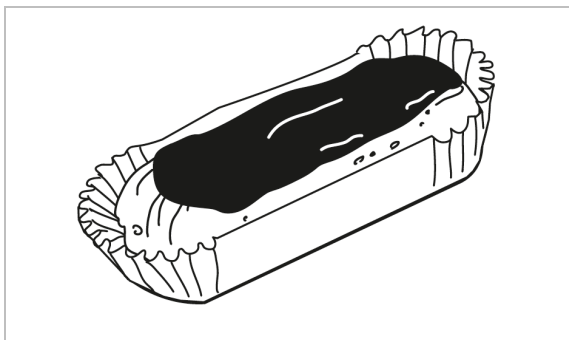
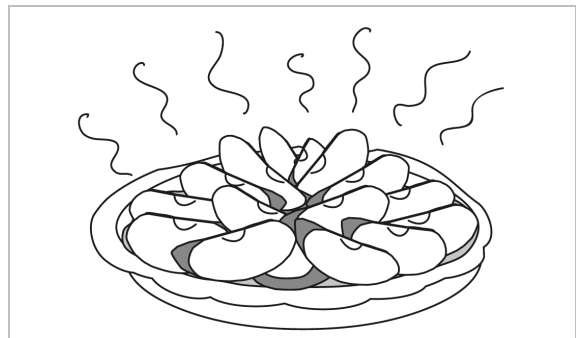
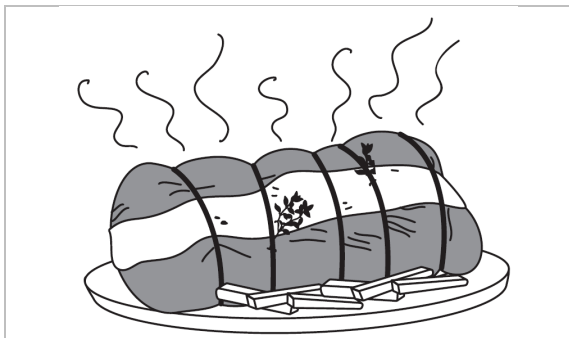
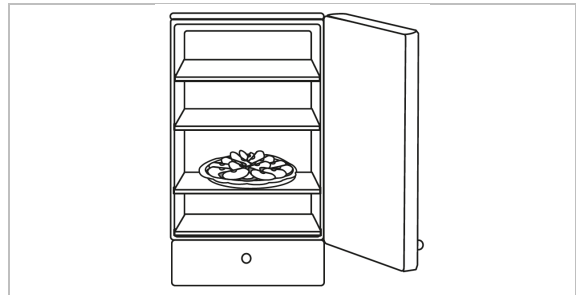
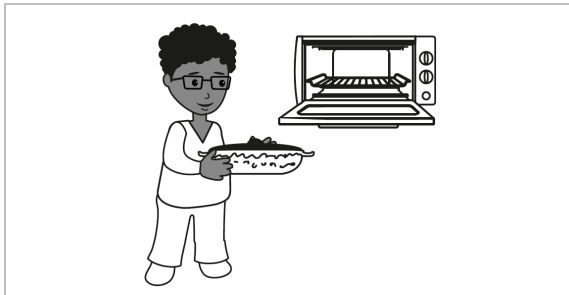
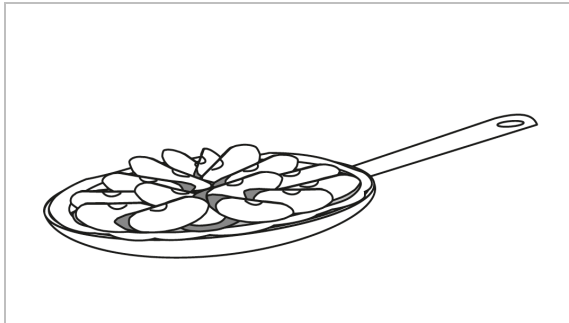

Exercise 9

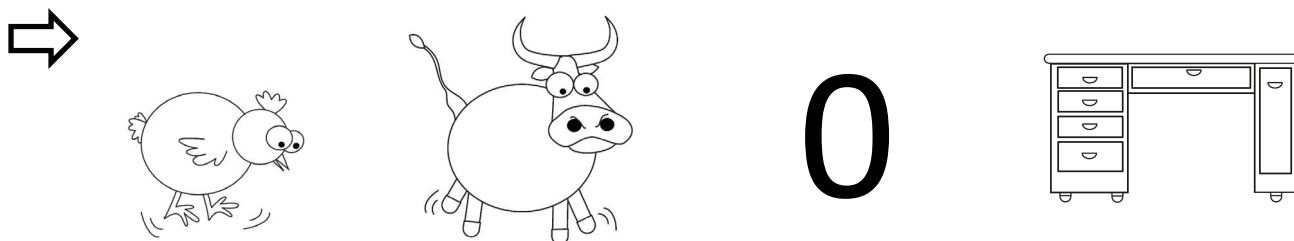
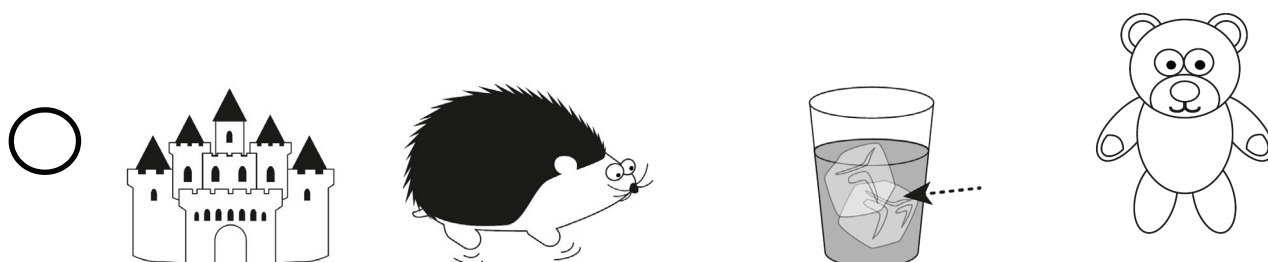
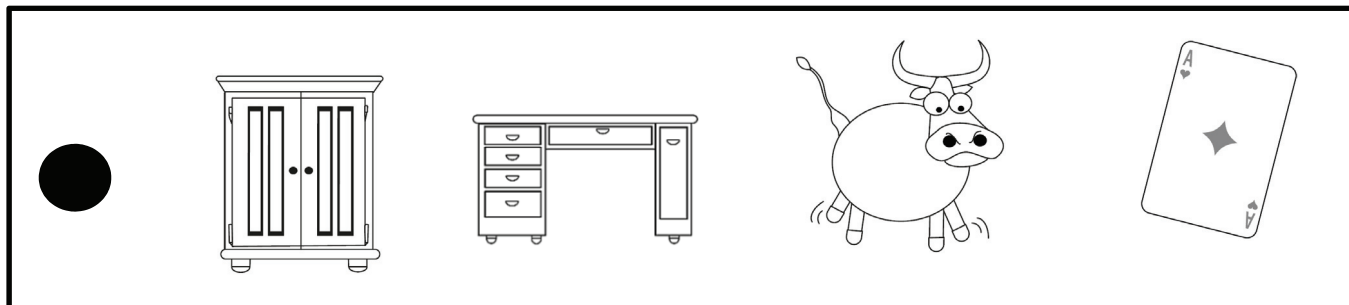

Exercice 9 (suite)

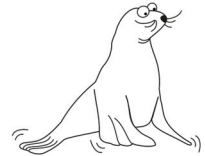
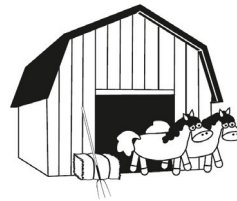
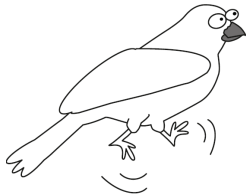
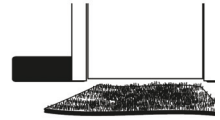
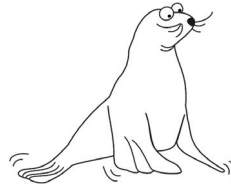

SÉQUENCE 4

MATHÉMATIQUES

Exercice 10

L'élève utilise son matériel habituel pour écrire.

Exercise 11



1 2 3 4 5 6



1 2 3 4 5 6

Exercice 11 (suite)



--	--	--	--	--	--	--

1 2 3 4 5 6



--	--	--	--	--	--	--

1 2 3 4 5 6

Exercise 12

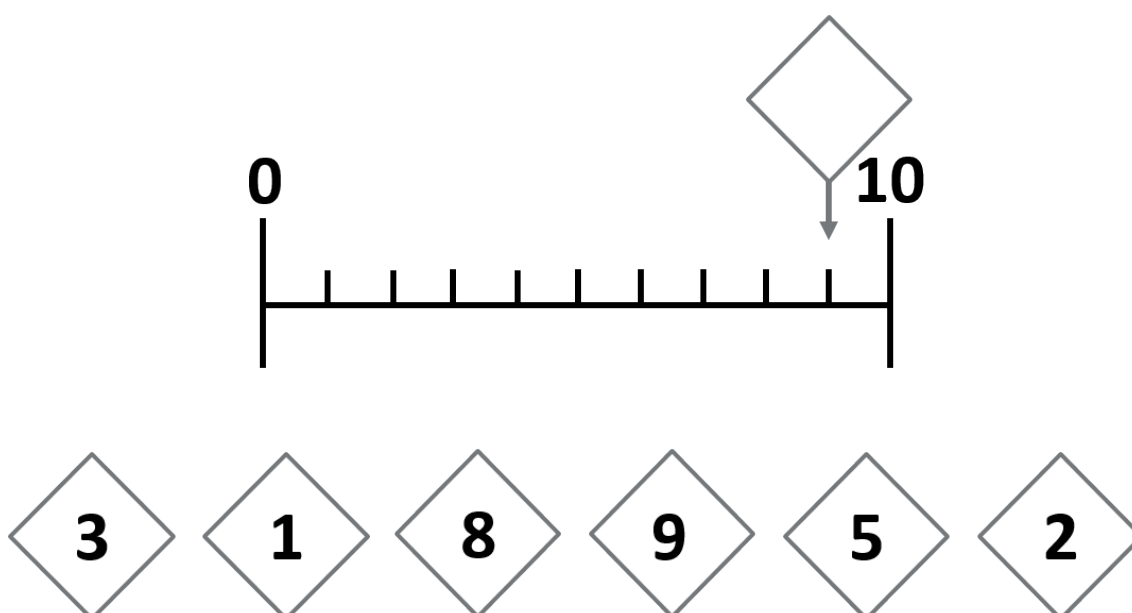
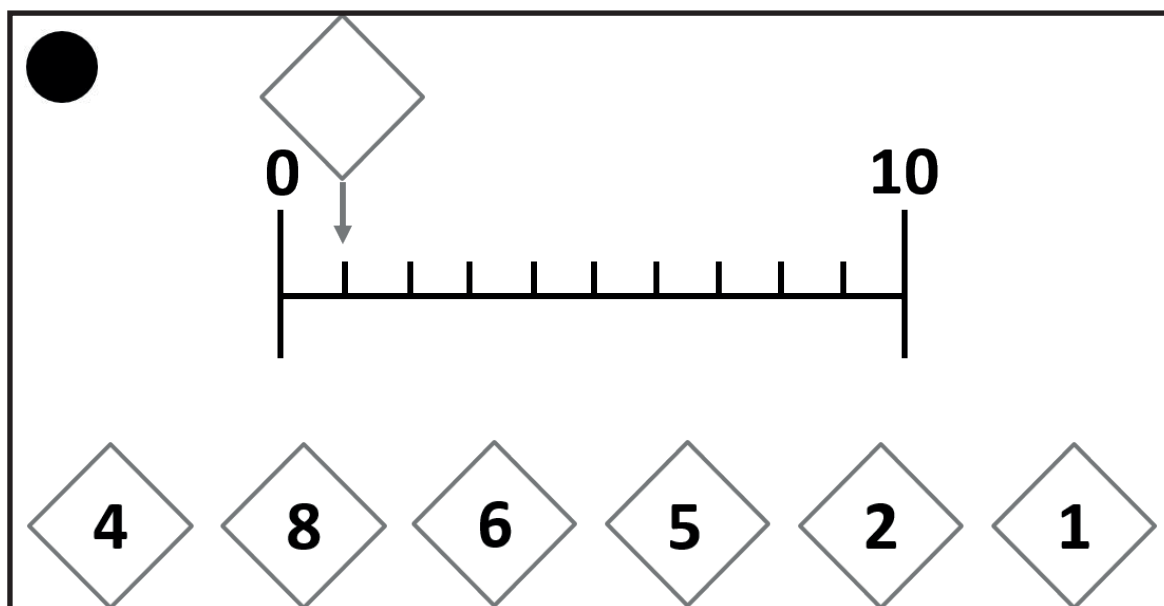

Exercice 12 (suite)

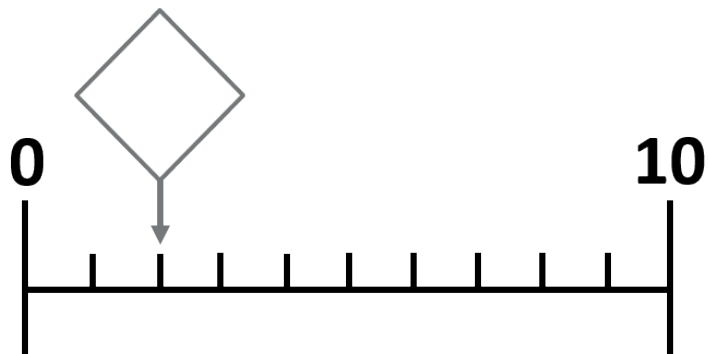
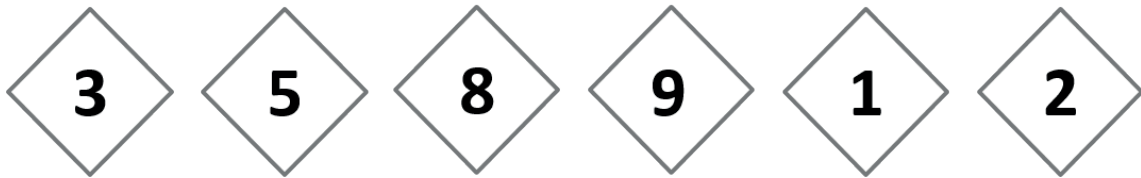
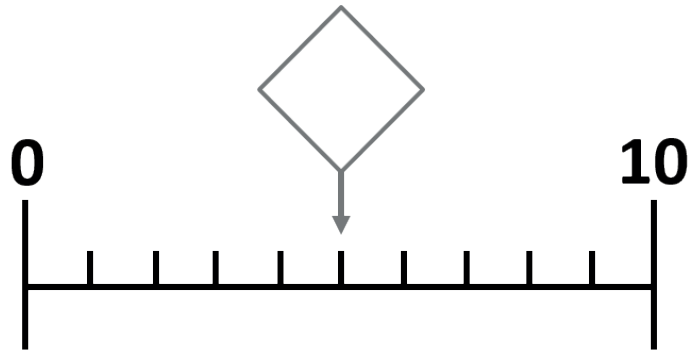

Exercice 12 (suite)

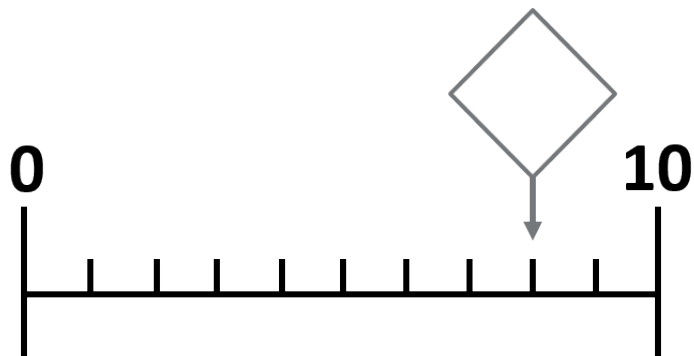
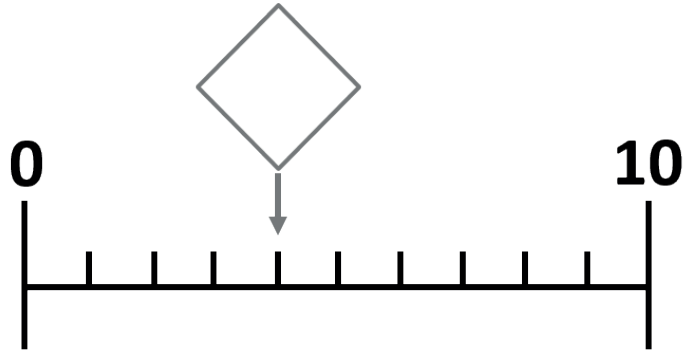

Exercice 12 (suite)

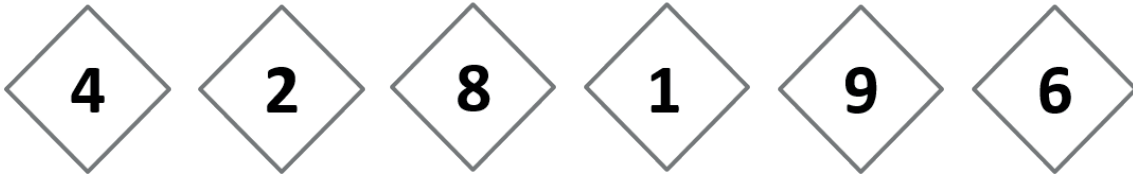
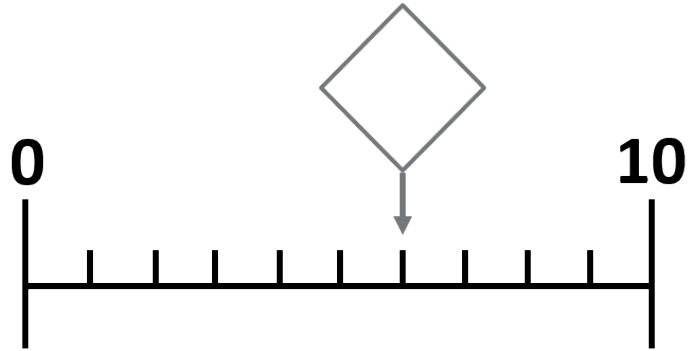

SÉQUENCE 5

FRANÇAIS

Exercise 13



m

n

b

d

f



s

r

p

t

f



m

s

r

b

d



m

b

d

f

j



l

t

d

h

f

Exercice 13 (suite)

 m b d f n

 h l v b d

 n m r t v

 n m r t s

 n d t s f

 n m v u f

Exercise 14

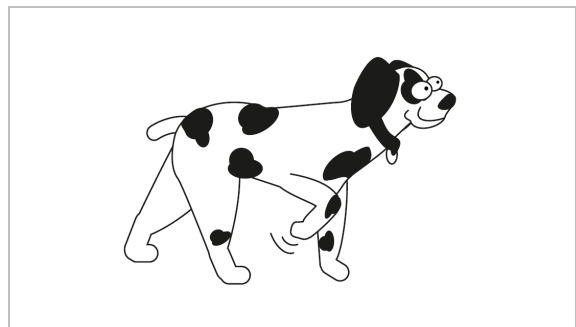
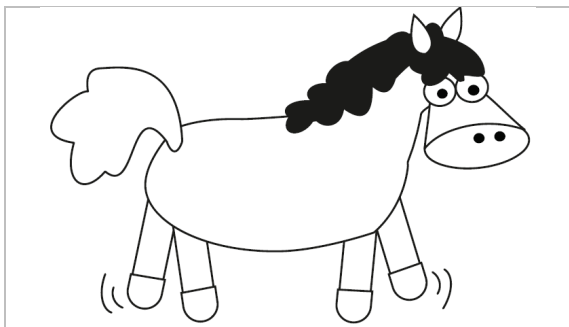
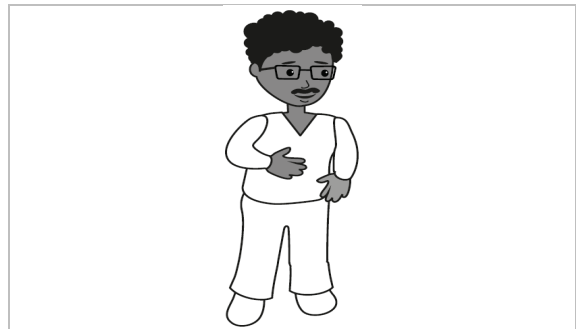
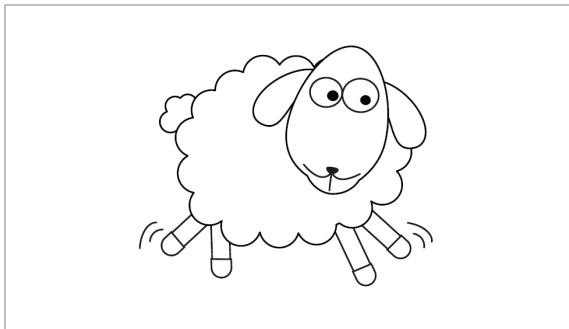
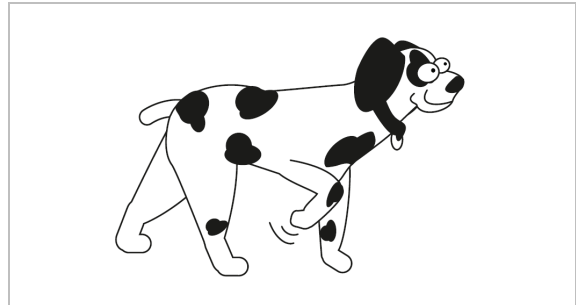
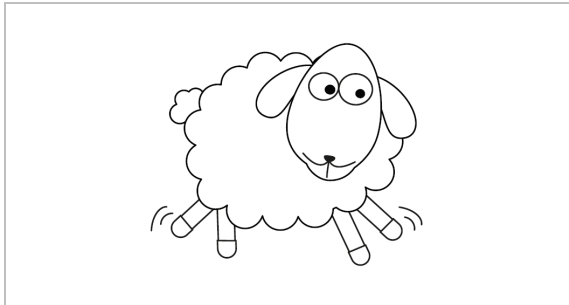
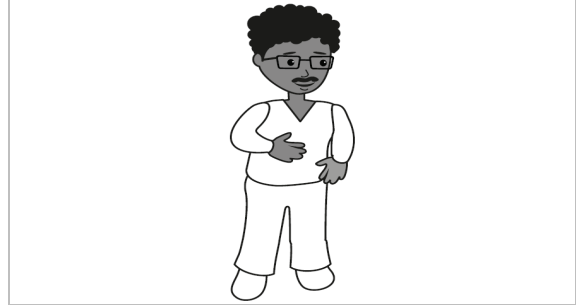
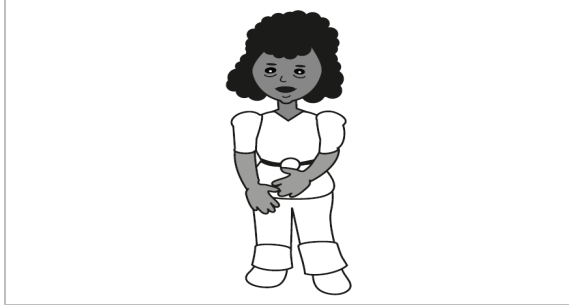

Exercice 14 (suite)

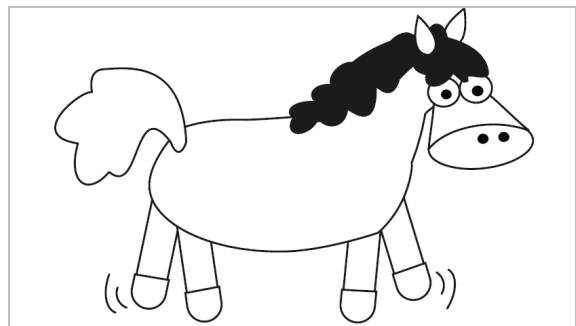
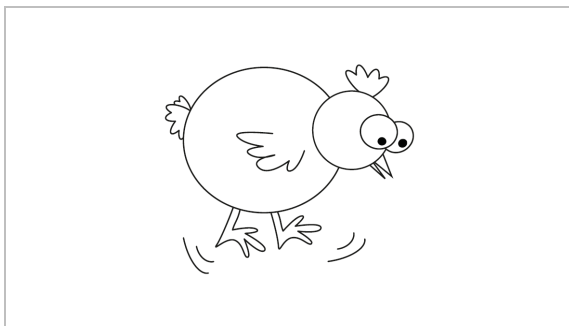
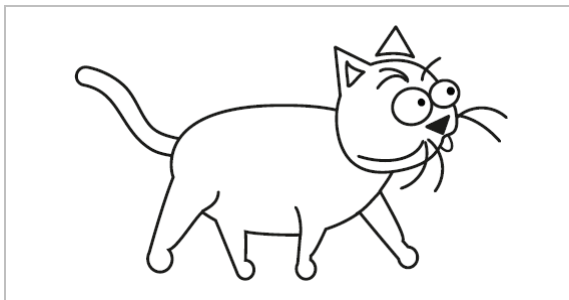
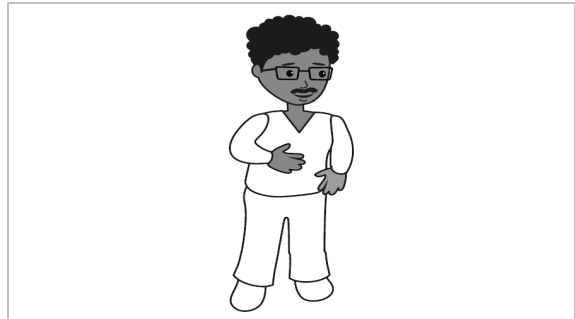
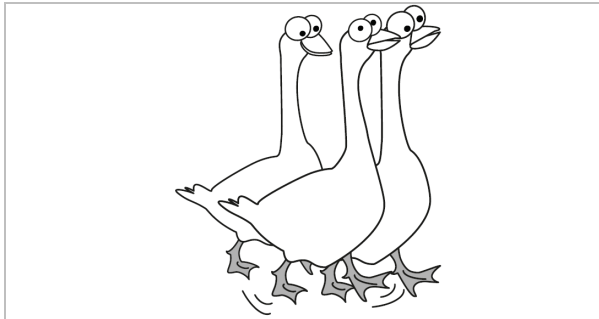
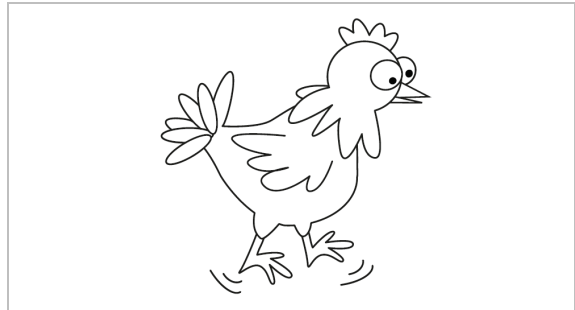
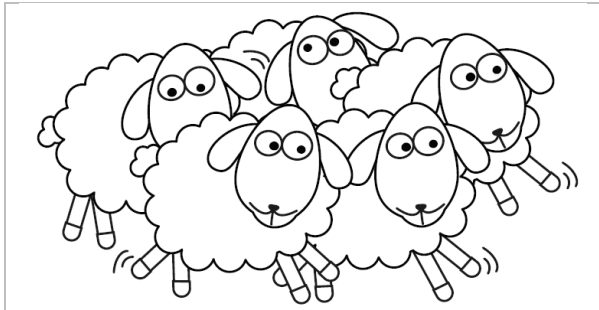

Exercise 15

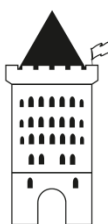
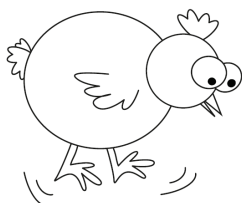
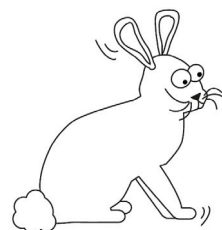
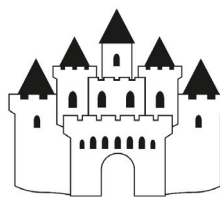
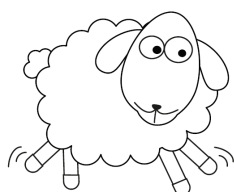
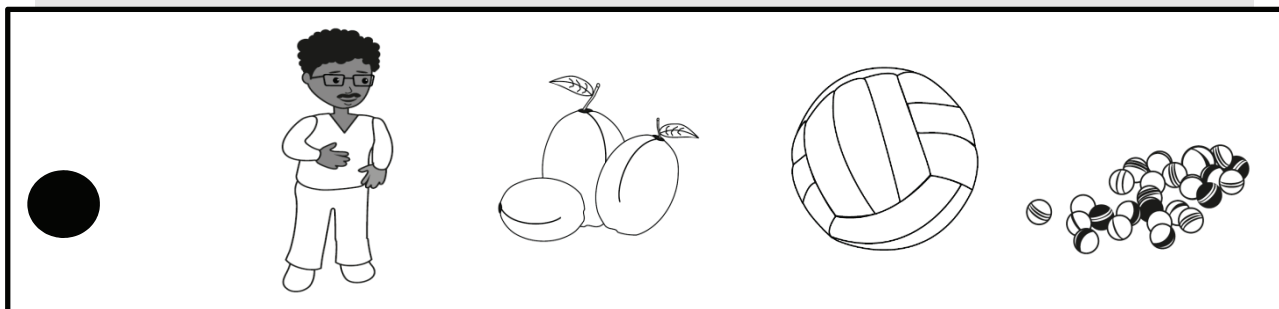

Exercice 15 (suite)

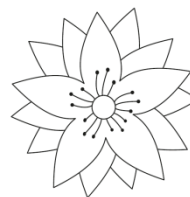
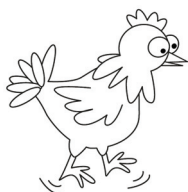
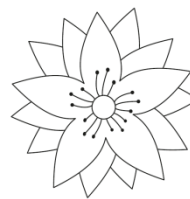
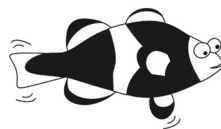
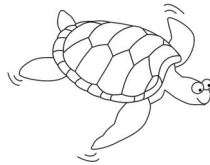
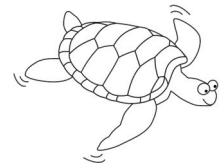
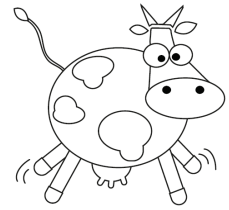
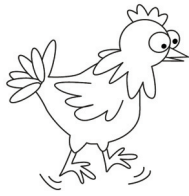

Exercise 16

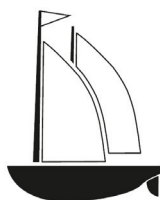
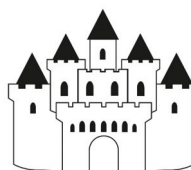
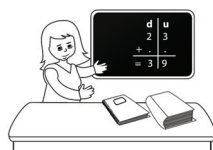
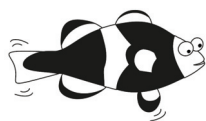
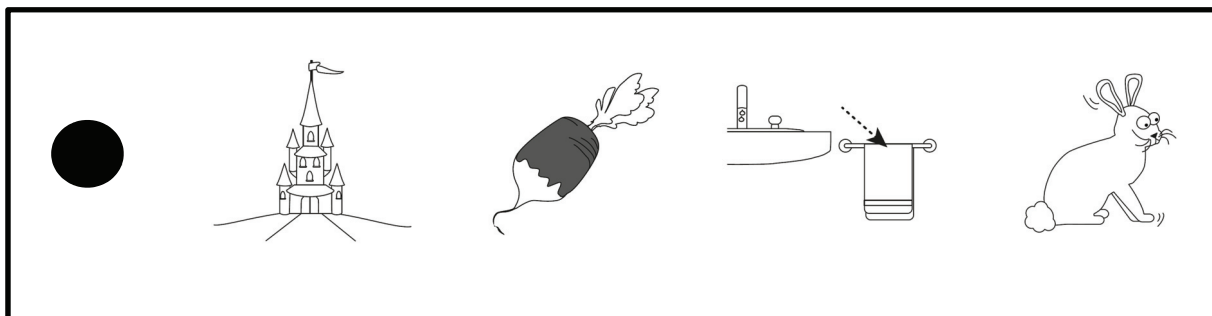

Exercice 16 (suite)

